

Technical data sheet

90° vertical bend, falling 60

Item no. 7007059

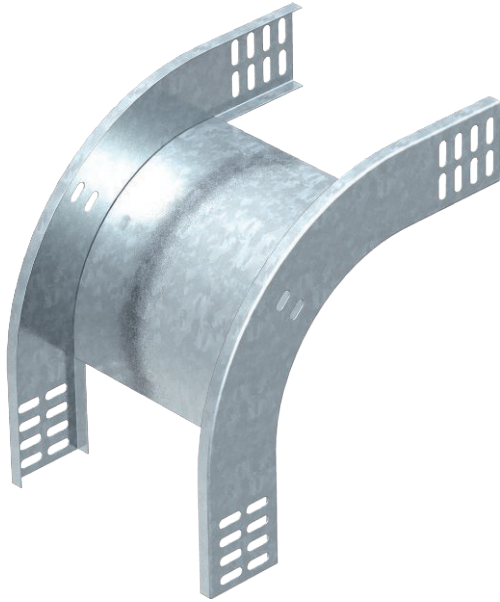

90° vertical bend, falling, for all cable tray types of 60 mm side height.

The vertical bend is pushed over the end of the cable tray and screwed tight. Fastening materials should be ordered separately.



St Steel

FS Strip galvanised

Master data

Item no.	7007059
Type	RBV 615 F FS
Description 1	90° vertical bend
Description 2	falling
Dimension	60x150
Material	Steel
Material symbol	St
Surface	Strip galvanised
Surface to DIN	DIN EN 10346
Surface symbol	FS
Smallest sales unit (VG)	1 Piece
Weight	73,00 kg/100 pc.

Technical data

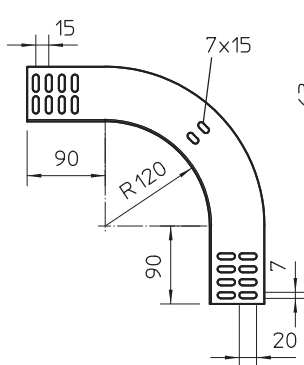

Width	150,00 mm
Side height	60,00 mm
Dimension B	150,00 mm
Bend (angle)	90°
Connector version	Without connectors
Plate thickness	1,00 mm
Suitable for maintaining electrical function	<input type="checkbox"/>
Mounting perforation in base	<input type="checkbox"/>
NATO hole pattern	<input type="checkbox"/>
Change of direction	Vertical, falling
Rustproof steel, pickled	<input type="checkbox"/>
Side perforation	<input type="checkbox"/>
Wide-span version	<input type="checkbox"/>