

# Technical data sheet

## 90° vertical bend, falling 35

Item no. 7007204

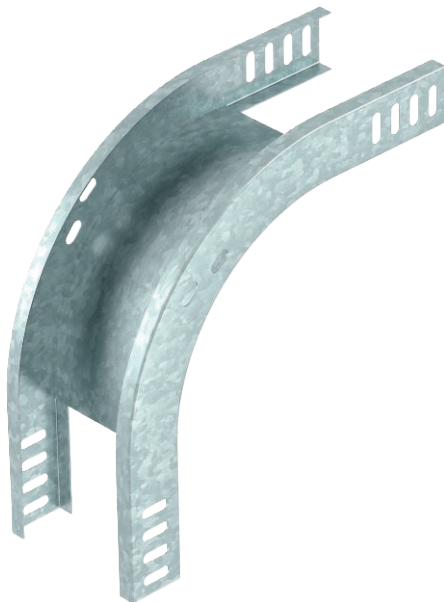

90° vertical bend, falling, for all cable tray types of 35 mm side height.

The vertical bend is pushed over the end of the cable tray and screwed tight. Fastening materials should be ordered separately.



**St** Steel

**FS** Strip galvanised

### Master data

Item no.	7007204
Type	RBV 310 F FS
Description 1	90° vertical bend
Description 2	falling
Dimension	35x100
Material	Steel
Material symbol	St
Surface	Strip galvanised
Surface to DIN	DIN EN 10346
Surface symbol	FS
Smallest sales unit (VG)	1 Piece
Weight	51,30 kg/100 pc.

### Technical data

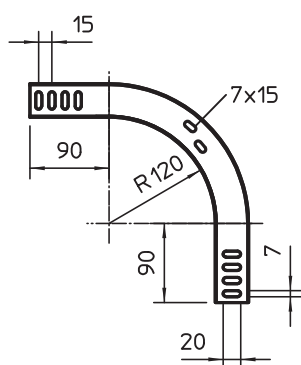

Width	100,00 mm
Side height	35,00 mm
Dimension B	100,00 mm
Bend (angle)	90°
Connector version	Without connectors
Plate thickness	1,00 mm
Suitable for maintaining electrical function	<input type="checkbox"/>
Mounting perforation in base	<input type="checkbox"/>
NATO hole pattern	<input type="checkbox"/>
Change of direction	Vertical, falling
Rustproof steel, pickled	<input type="checkbox"/>
Side perforation	<input type="checkbox"/>
Wide-span version	<input type="checkbox"/>