

# Technical data sheet

## 90° Magic bend 60

Item no. 6041130

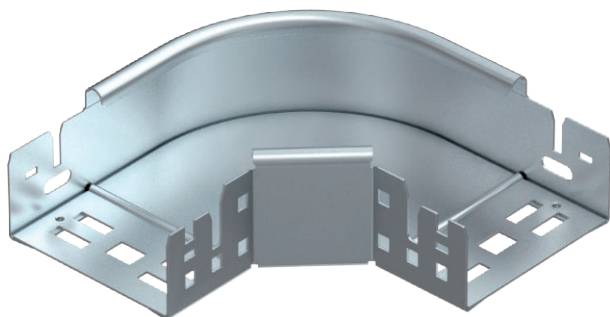

90° bend with quick connector system. For all cable tray types of 60 mm side height.



<b>St</b>	Steel
<b>FS</b>	Strip galvanised

### Master data

Item no.	6041130
Type	RBM 90 610 FS
Description 1	90° bend
Description 2	with quick connector
Dimension	60x100
Material	Steel
Material symbol	St
Surface	Strip galvanised
Surface to DIN	DIN EN 10346
Surface symbol	FS
Smallest sales unit (VG)	1 Piece
Weight	65,70 kg/100 pc.

### Technical data

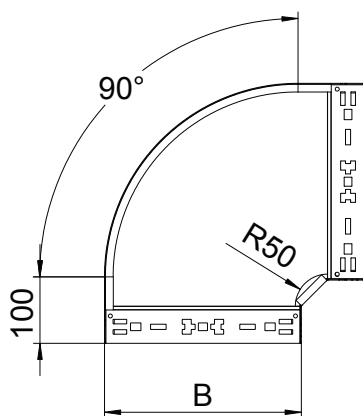

Width	100,00 mm
Side height	60,00 mm
Dimension B	100,00 mm
Bend (angle)	90°
Connector version	Integrated connector
Plate thickness	1,25 mm
Dimension	60x100 mm
Suitable for maintaining electrical function	<input type="checkbox"/>
Mounting perforation in base	<input type="checkbox"/>
NATO hole pattern	<input type="checkbox"/>
Change of direction	Horizontal
Rustproof steel, pickled	<input type="checkbox"/>
Side perforation	<input type="checkbox"/>
Wide-span version	<input type="checkbox"/>