

Technical data sheet

Cable tray MKS-Magic® 110, unperforated

Item no. 6059403

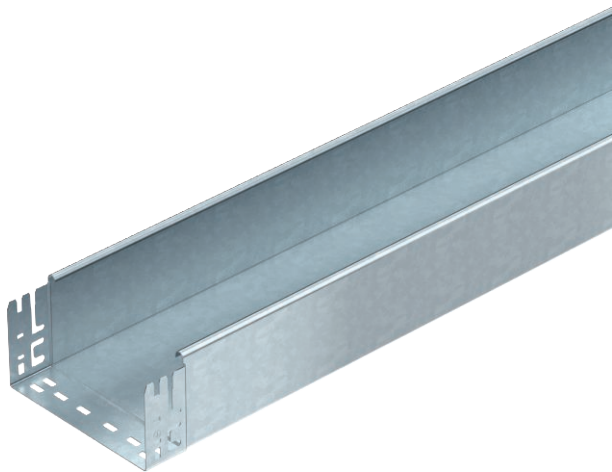

Unperforated cable tray with integrated quick fastening system. The usable length of the cable tray is 3,000 mm.

Continuous equipotential bonding is guaranteed without additional components.



St Steel

FT Hot-dip galvanised

Master data

Item no.	6059403
Type	MKSMU 120 FT
Description 1	Cable tray MKSMU
Description 2	unperforated, quick connector
Manufacturer	OBO
Dimension	110x200x3050
Material	Steel
Material symbol	St
Surface	Hot-dip galvanised
Surface to DIN	DIN EN ISO 1461
Surface symbol	FT
Smallest sales unit (VG)	3 m
Weight	382,59 kg/100 m

Technical data



Usable cross-section	21.800,00 mm ²
Usable cross-section	218,00 cm ²
Suitable for maintaining electrical function	<input type="checkbox"/>
Connector version	Integrated connector
With cover	<input type="checkbox"/>
Mounting perforation in base	<input type="checkbox"/>
NATO hole pattern	<input type="checkbox"/>
Rustproof steel, pickled	<input type="checkbox"/>
Side perforation	<input type="checkbox"/>
Wide-span version	<input type="checkbox"/>

Technical data sheet

Cable tray MKS-Magic® 110, unperforated

Item no. 6059403



Technical data

Dimensions

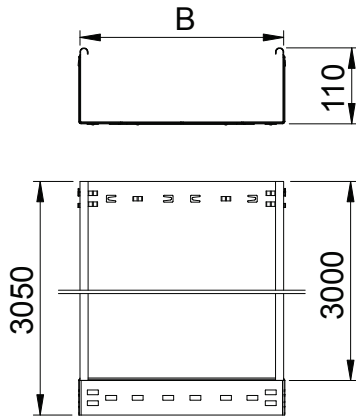

Length	3.050,00 mm
Width	200,00 mm
Height	110,00 mm
Side height	110,00 mm
Dimension B	200,00 mm
Plate thickness	1,00 mm

Appr. load:

Support spacing 1.5 m	1,85 kN/m
Support spacing 2.0 m	1,30 kN/m
Support spacing 2.5 m	0,75 kN/m
Support spacing 3.0 m	0,60 kN/m

Load diagram, cable tray, type MKSMU 110

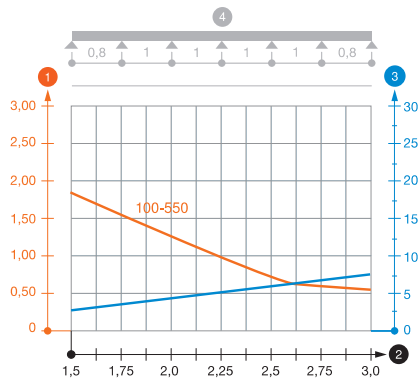

- 1 Permitted cable tray/ladder load in kN/m without man load
- 2 Support width in m
- 3 Rail bend in mm at permitted kN/m
- 4 Load scheme during testing
- Load curve with cable tray/ladder width in mm
- Strut bend curve according to support width