

Technical data sheet

Angle connector 60

Item no. 6208898

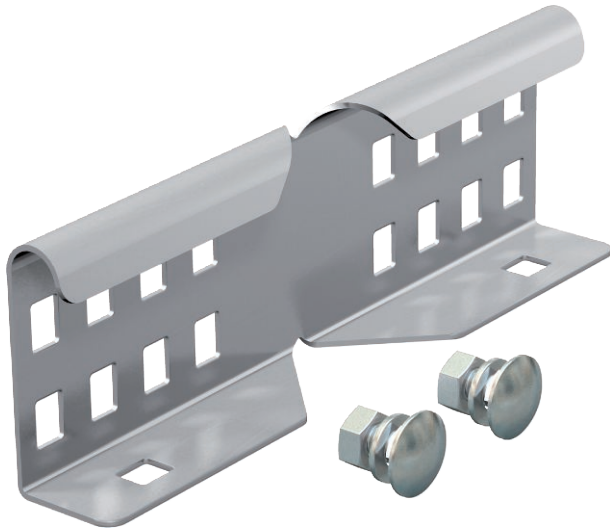

Angle connector as external connector to join cable ladders and fittings with a side height of 60 mm and continuous rail perforation.

The bolt fastening ensures the continuity of the equipotential bonding.



VA Stainless steel, rustproof 1.4301

2B Bright, reworked

Master data

Item no.	6208898
Type	LWVG 60 A2
Description 1	Angle connector
Description 2	for cable ladder
Dimension	64x150
Material	Stainless steel, material no. 1.4301
Material symbol	A2
Surface	Bright, reworked
Surface symbol	2B
Smallest sales unit (VG)	10 Piece
Weight	24,00 kg/100 pc.

Technical data

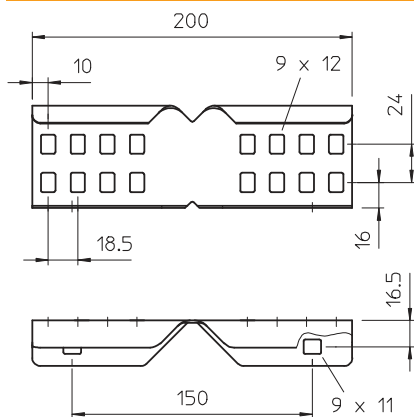

Length	200,00 mm
Width	28,00 mm
Height	64,00 mm
Side height	60,00 mm
Dimension	64x150 mm
Version	Angle connector
Plate thickness	1,50 mm
Suitable for cable tray system height	60,00 mm
Suitable for cable tray	<input type="checkbox"/>
Suitable for mesh cable tray	<input type="checkbox"/>
Suitable for cable ladder	<input checked="" type="checkbox"/>
Adjustable connector, horizontal	<input type="checkbox"/>
Adjustable connector, vertical	<input type="checkbox"/>
Rustproof steel, pickled	<input type="checkbox"/>
Connection type	Screw connector