

Technical data sheet

T piece VS 60

Item no. 6213847

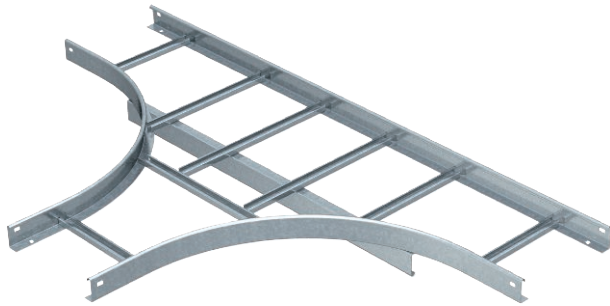

Tee, horizontal, for cable ladders with medium-duty rungs (VS) and a side height of 60 mm.



St	Steel
FT	Hot-dip galvanised

Additional product text, instruction	Connectors should be ordered separately and in the appropriate quantity.
Additional product text 2	Additional widths are available on request.

Master data

Item no.	6213847
Type	LT 640 VS FT
Description 1	Tee
Description 2	for cable ladder with VS rung
Dimension	60x400
Material	Steel
Material symbol	St
Surface	Hot-dip galvanised
Surface to DIN	DIN EN ISO 1461
Surface symbol	FT
Smallest sales unit (VG)	1,00 Piece
Weight	924,00 kg/100 pc.

Technical data

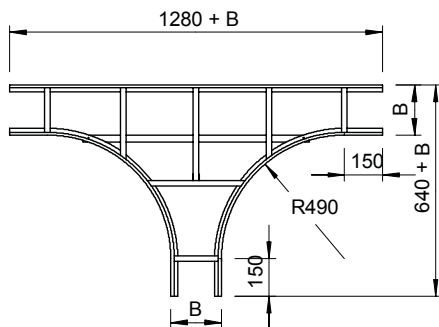

Width	400,00 mm
Side height	60,00 mm
Dimension R	490,00 mm
Rung version	Profile unperforated
Side rail version	Flat profile
Shape	Exit symmetrical
Suitable for maintaining electrical function	<input type="checkbox"/>
Rail thickness	1,50 mm
Rustproof steel, pickled	<input type="checkbox"/>
Wide-span version	<input type="checkbox"/>