

Technical data sheet

Cable ladder LCIS 60, 3 m C30

Item no. 6209729

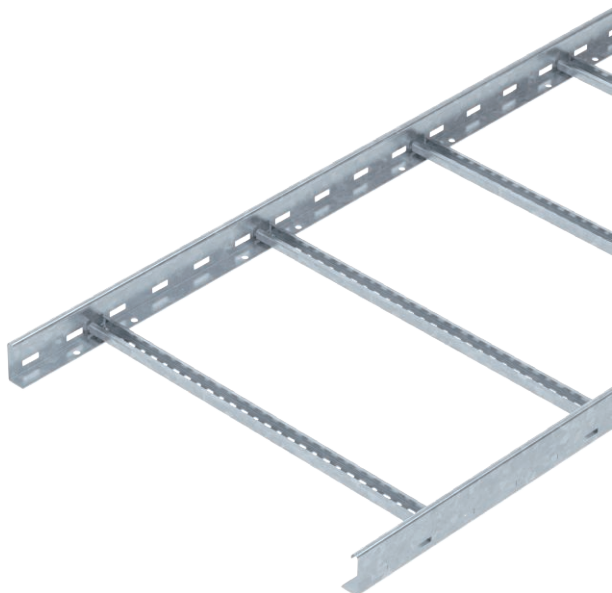

Cable ladder with a 60 mm side height with welded C30 profile rungs which are open in an upwards direction. Rolled side rail for reinforcement and as edge protection. Fastening to the bracket takes place using clamping pieces, type LKS 40. The slot dimension of the rung is 16.5 mm and the appropriate clamp clip is type 2056.

Magnetic shield insulation without cover 10 dB, with cover 15 dB.



- St** Steel
- FT** Hot-dip galvanised

Master data

Item no.	6209729
Type	LCIS 660 3 FT
Description 1	Cable ladder
Description 2	perforated rung, welded
Dimension	60x600x3000
Material	Steel
Material symbol	St
Surface	Hot-dip galvanised
Surface to DIN	DIN EN ISO 1461
Surface symbol	FT
Smallest sales unit (VG)	3 m
Weight	375,34 kg/100 m

Technical data

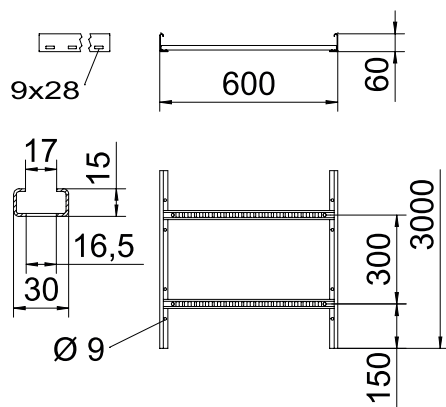

Length	3.000,00 mm
Width	600,00 mm
Height	60,00 mm
Side height	60,00 mm
Dimension B	600,00 mm
Rung version	Profile perforated
Side rail version	Flat profile
Fastening of rung	Welded
Suitable for maintaining electrical function	<input type="checkbox"/>
Rail thickness	1,50 mm
Usable cross-section	24.000,00 mm ²
Usable cross-section	240,00 cm ²
Rustproof steel, pickled	<input type="checkbox"/>
Side perforation	<input checked="" type="checkbox"/>
Rung distance	300,00 mm
Wide-span version	<input type="checkbox"/>

Technical data sheet

Cable ladder LCIS 60, 3 m C30

Item no. 6209729



Technical data

Appr. load:

Support spacing 1.5 m	3,30 kN/m
Support spacing 2.0 m	2,00 kN/m
Support spacing 2.5 m	1,30 kN/m
Support spacing 3.0 m	1,00 kN/m
Support spacing 3.5 m	0,78 kN/m
Support spacing 4.0 m	0,40 kN/m

Load diagram LCIS 60

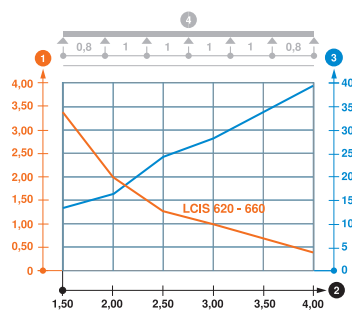

- 1 Permitted cable tray/ladder load in kN/m without man load
- 2 Support width in m
- 3 Rail bend in mm at permitted kN/m
- 4 Load scheme during testing
- Load curve with cable tray/ladder width in mm
- Strut bend curve according to support width