

Technical data sheet

90° bend 45

Item no. 6203167

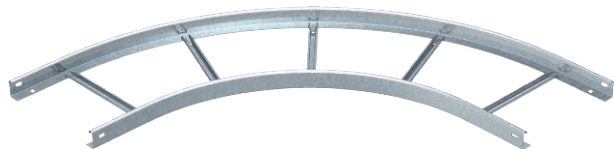

90° bend, horizontal, for all cable ladder types of 45 mm side height.



St	Steel
FT	Hot-dip galvanised

Additional product text, instruction | Connectors should be ordered separately and in the appropriate quantity.

Master data

Item no.	6203167
Type	LBI 90 460 NS FT
Description 1	90° bend
Description 2	for cable ladder with NS rung
Dimension	45x600
Material	Steel
Material symbol	St
Surface	Hot-dip galvanised
Surface to DIN	DIN EN ISO 1461
Surface symbol	FT
Smallest sales unit (VG)	1,00 Piece
Weight	491,20 kg/100 pc.

Technical data

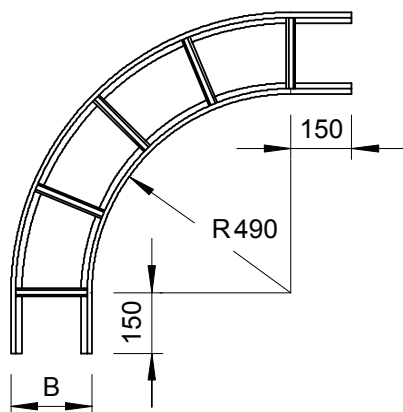

Width	600,00 mm
Side height	45,00 mm
Dimension R	490,00 mm
Bend (angle)	90°
Connector version	Without connectors
Rung version	Profile unperforated
Side rail version	Flat profile
Suitable for maintaining electrical function	<input type="checkbox"/>
Rail thickness	1,50 mm
Change of direction	Horizontal
Rustproof steel, pickled	<input type="checkbox"/>
Hinged	<input type="checkbox"/>
Side perforation	<input type="checkbox"/>
Wide-span version	<input type="checkbox"/>