

Technical data sheet

90° bend 45

Item no. 6203078

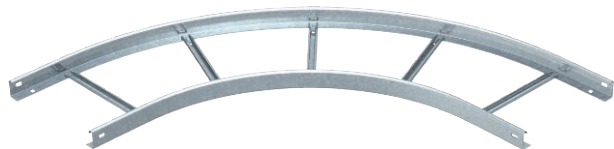

90° bend, horizontal, for all cable ladder types of 45 mm side height.



St	Steel
FS	Strip galvanised

Additional product text, instruction | Connectors should be ordered separately and in the appropriate quantity.

Master data

Item no.	6203078
Type	LBI 90 460 NS FS
Description 1	90° bend
Description 2	for cable ladder with NS rung
Dimension	45x600
Material	Steel
Material symbol	St
Surface	Strip galvanised
Surface to DIN	DIN EN 10346
Surface symbol	FS
Smallest sales unit (VG)	1,00 Piece
Weight	457,40 kg/100 pc.

Technical data

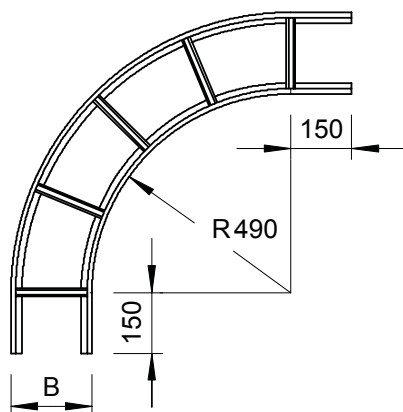

Width	600,00 mm
Side height	45,00 mm
Dimension R	490,00 mm
Bend (angle)	90°
Connector version	Without connectors
Rung version	Profile unperforated
Side rail version	Flat profile
Suitable for maintaining electrical function	<input type="checkbox"/>
Rail thickness	1,50 mm
Change of direction	Horizontal
Rustproof steel, pickled	<input type="checkbox"/>
Hinged	<input type="checkbox"/>
Side perforation	<input type="checkbox"/>
Wide-span version	<input type="checkbox"/>