

Technical data sheet

Add-on tee

Item no. 6225838

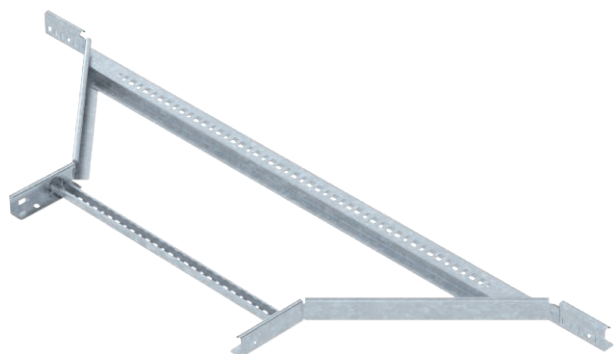

Add-on tee with welded rung for use in the cable ladder types with a side height of 45 mm.



St	Steel
FT	Hot-dip galvanised

Additional product text, instruction
Connectors should be ordered separately and in the appropriate quantity.

Master data

Item no.	6225838
Type	LAA 460 R3 FT
Description 1	Add-on tee
Description 2	for cable ladder
Dimension	45x600
Material	Steel
Material symbol	St
Surface	Hot-dip galvanised
Surface to DIN	DIN EN ISO 1461
Surface symbol	FT
Smallest sales unit (VG)	1,00 Piece
Weight	361,00 kg/100 pc.

Technical data

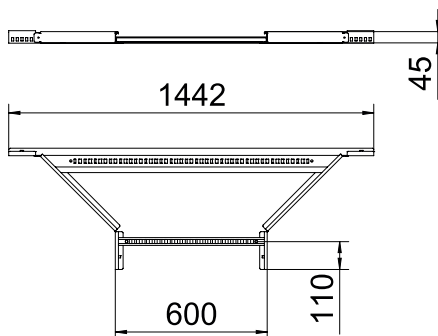

Width	600,00 mm
Side height	45,00 mm
Dimension B	600,00 mm
Dimension R	300,00 mm
Connector version	Without connectors
Rung version	Profile perforated
Side rail version	Flat profile
Suitable for maintaining electrical function	<input type="checkbox"/>
Rail thickness	1,25 mm
Rustproof steel, pickled	<input type="checkbox"/>
Wide-span version	<input type="checkbox"/>