

Technical data sheet

Magic straight connector set 60

Item no. 6068940

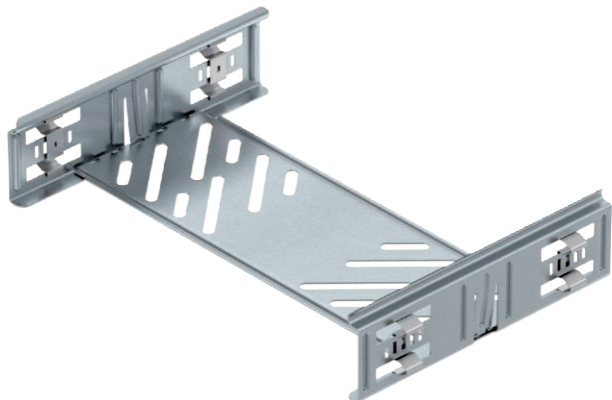

Cable tray connector with quick fastening for the screwless connection of perforated cable trays with a side height of 60 mm.

The optimised design means that the connector can be used to create radii and as a length compensation piece for large temperature deviations.



St Steel

DD Strip galvanised zinc/aluminium, Double Dip

Master data

Item no.	6068940
Type	KTSMV 620 DD
Description 1	Straight connector set
Description 2	for cable tray Magic
Dimension	60x200x200
Material	Steel
Material symbol	St
Surface	Strip galvanised zinc/aluminium, Double Dip
Surface to DIN	DIN EN 10346
Surface symbol	DD
Smallest sales unit (VG)	1 Piece
Weight	37,20 kg/100 pc.

Technical data

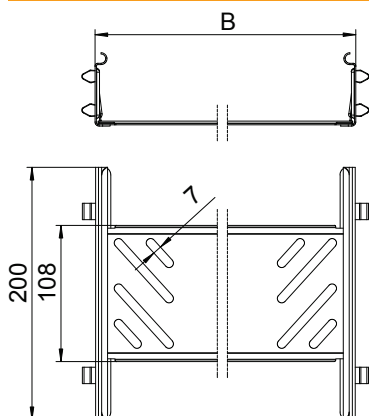

Length	200,00 mm
Width	200,00 mm
Width	8,00 in
Side height	60,00 mm
Side height	2,00 in
Dimension B	200,00 mm
Dimension	60x200 mm
Version	Straight connector
Plate thickness	1,00 mm
Suitable for cable tray system height	60,00 mm
Suitable for cable tray	<input checked="" type="checkbox"/>
Suitable for mesh cable tray	<input type="checkbox"/>
Suitable for cable ladder	<input type="checkbox"/>
Suitable for maintaining electrical function	<input type="checkbox"/>
Adjustable connector, horizontal	<input type="checkbox"/>
Adjustable connector, vertical	<input type="checkbox"/>
Rustproof steel, pickled	<input type="checkbox"/>
Connection type	Screwless connector