

Technical data sheet

Mesh cable tray GR-Magic® 35

Item no. 6000063

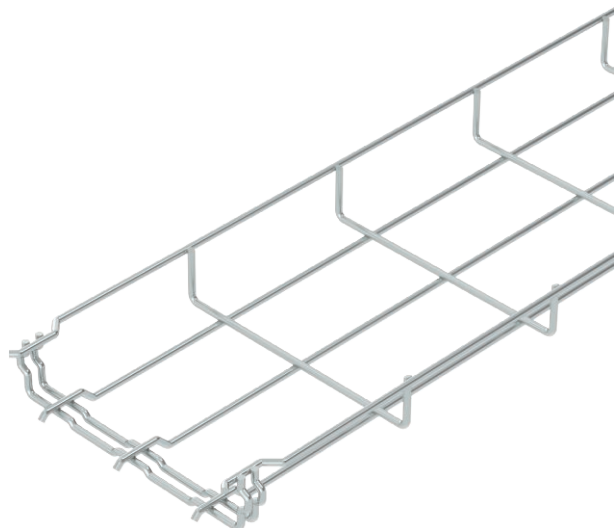

Mesh cable tray with shaped connector of side height 35 mm.

No additional connection components are required for the mesh cable tray, it is simply interlocked. The grid width is 50 x 100 mm (exception: GRM 35/50 = 20 x 100 mm).

Magnetic shield insulation without cover 15 dB, with cover 25 dB.

10



St	Steel
G	Electrogalvanised

Master data

Item no.	6000063
Type	GRM 35 150 G
Description 1	Mesh cable tray GRM
Dimension	35x150x3000
Material	Steel
Material symbol	St
Surface	Electrogalvanised
Surface to DIN	EN ISO 19598 / EN ISO 4042
Surface symbol	G
Smallest sales unit (VG)	3 m
Weight	63,33 kg/100 m

Technical data

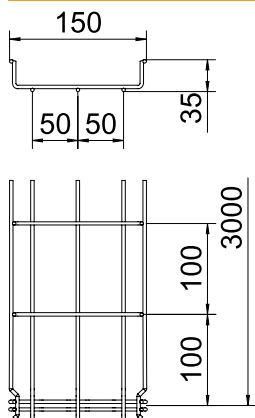

Length	3.000,00 mm
Width	150,00 mm
Height	35,00 mm
Side height	35,00 mm
Dimension B	150,00 mm
Connector version	Integrated connector
Wire diameter	3,90 mm
Suitable for maintaining electrical function	<input type="checkbox"/>
Integrated partition	Without
Usable cross-section	52,50 cm ²
Usable cross-section	5.250,00 mm ²
Profile shape	U-shaped
Rustproof steel, pickled	<input type="checkbox"/>
Wide-span version	<input type="checkbox"/>

Appr. load:

Support spacing 1.0 m	0,25 kN/m
Support spacing 1.5 m	0,11 kN/m
Support spacing 2.0 m	0,10 kN/m

Technical data