

Technical data sheet

Centre suspension mesh cable tray

Item no. 6015247



Two-part centre suspension of mesh cable trays.

When filling with cables, please ensure an even distribution. The maximum recommended mesh cable tray width is 200 mm.



- St** Steel
- FS** Strip galvanised

Master data

Item no.	6015247
Type	GMA M10 FS
Description 1	Centre suspension
Description 2	for threaded rod M10
Dimension	60x40
Material	Steel
Material symbol	St
Surface	Strip galvanised
Surface to DIN	DIN EN 10346
Surface symbol	FS
Smallest sales unit (VG)	25 Piece
Weight	8,30 kg/100 pc.

Technical data

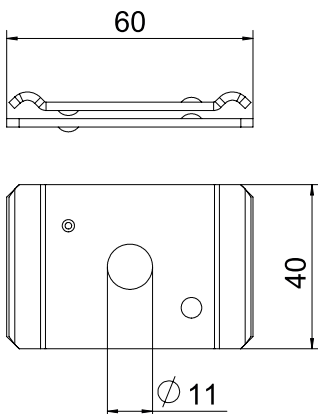

Length	65,00 mm
Width	40,00 mm
Height	10,10 mm
Version	Suspended
Suitable for maintaining electrical function	<input type="checkbox"/>
Hole diameter	11,00 mm
Adjustable	<input type="checkbox"/>