

# Technical data sheet

## Magic 60 fitting connector

Item no. 6065714

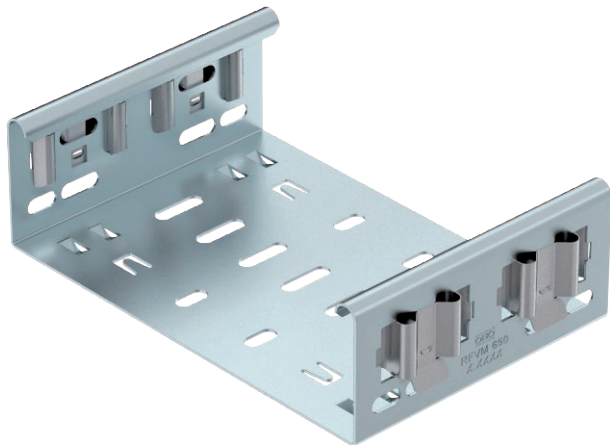

Magic straight connector for direct and screwless joining of Magic fittings with a side height of 60 mm.

The straight connector is equipped with four brackets and can also be used for the direct connection with a cut cable tray with only two brackets mounted to one side. To join a cut cable tray with a fitting, an additional Magic straight connector set is needed.

The fitting connector is compatible with cable tray types MKSM, MKSMU, SKSM and SKSMU.



- St** Steel
- DD** Strip galvanised zinc/aluminium, Double Dip

### Master data

Item no.	6065714
Type	FVM 620 DD
Description 1	Straight connector
Description 2	with quick connector
Dimension	60x200
Material	Steel
Material symbol	St
Surface	Strip galvanised zinc/aluminium, Double Dip
Surface to DIN	DIN EN 10346
Surface symbol	DD
Smallest sales unit (VG)	1 Piece
Weight	44,00 kg/100 pc.

### Technical data

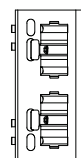
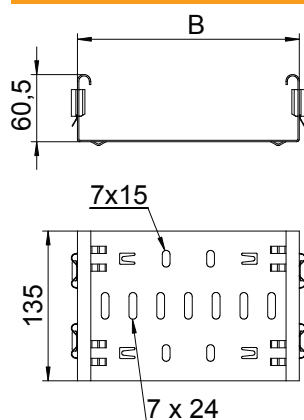

Length	135,00 mm
Width	200,00 mm
Width	8,00 in
Height	60,00 mm
Side height	60,00 mm
Side height	2,00 in
Dimension B	200,00 mm
Version	Straight connector
Suitable for cable tray system height	60,00 mm
Suitable for cable tray	<input checked="" type="checkbox"/>
Suitable for mesh cable tray	<input type="checkbox"/>
Suitable for cable ladder	<input type="checkbox"/>
Suitable for maintaining electrical function	<input type="checkbox"/>
Adjustable connector, horizontal	<input type="checkbox"/>
Adjustable connector, vertical	<input type="checkbox"/>
Rustproof steel, pickled	<input type="checkbox"/>
Connection type	Screwless connector
Wide-span version	<input type="checkbox"/>