

# Technical data sheet

## Cover with turn buckle

Item no. 6052715

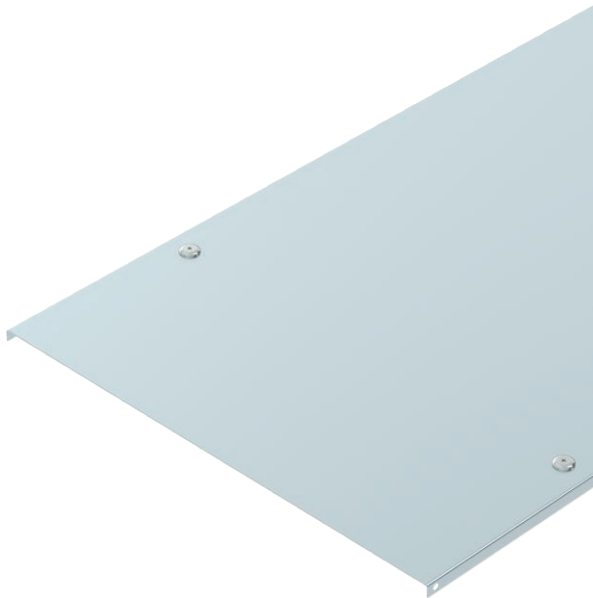

Cover for cable trays and cable ladders with turn buckles.

Transverse bead from 500 mm width.

When using covers outdoors, additional measures against the influence of wind must be taken.



**St** Steel

**DD** Strip galvanised zinc/aluminium, Double Dip

### Master data

Item no.	6052715
Type	DRL 400 DD
Description 1	Cover with turn buckle
Description 2	for cable tray and ladder
Manufacturer	OBO
Dimension	400x3000
Material	Steel
Material symbol	St
Surface	Strip galvanised zinc/aluminium, Double Dip
Surface to DIN	DIN EN 10346
Surface symbol	DD
Smallest sales unit (VG)	3 m
Weight	342,07 kg/100 m

### Technical data

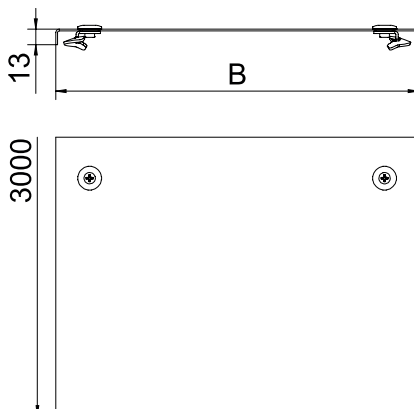

Length	3.000,00 mm
Width	400,00 mm
Side height	35,00 mm
Dimension B	400,00 mm
Dimension H	15,00 mm
Number of turn buckles	6,00 pc.
Fastening type	Turn buckle
Plate thickness	1,00 mm
Suitable for cable tray	<input checked="" type="checkbox"/>
Suitable for mesh cable tray	<input type="checkbox"/>
Suitable for cable ladder	<input checked="" type="checkbox"/>
Suitable for maintaining electrical function	<input type="checkbox"/>
Rustproof steel, pickled	<input type="checkbox"/>