

Technical data sheet

Cover with turn buckle

Item no. 6052712

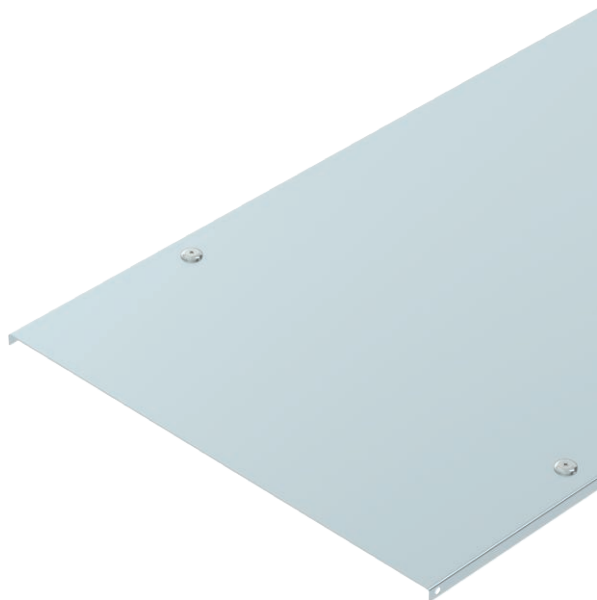

Cover for cable trays and cable ladders with turn buckles.

Transverse bead from 500 mm width.

When using covers outdoors, additional measures against the influence of wind must be taken.



St Steel

DD Strip galvanised zinc/aluminium, Double Dip

Master data

| | |
|--------------------------|---|
| Item no. | 6052712 |
| Type | DRL 300 DD |
| Description 1 | Cover with turn buckle |
| Description 2 | for cable tray and ladder |
| Manufacturer | OBO |
| Dimension | 300x3000 |
| Material | Steel |
| Material symbol | St |
| Surface | Strip galvanised zinc/aluminium, Double Dip |
| Surface to DIN | DIN EN 10346 |
| Surface symbol | DD |
| Smallest sales unit (VG) | 3 m |
| Weight | 263,34 kg/100 m |

Technical data

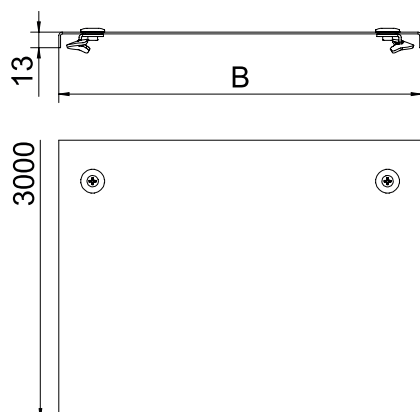

| | |
|--|-------------------------------------|
| Length | 3.000,00 mm |
| Width | 300,00 mm |
| Side height | 35,00 mm |
| Dimension B | 300,00 mm |
| Dimension H | 15,00 mm |
| Number of turn buckles | 6,00 pc. |
| Fastening type | Turn buckle |
| Plate thickness | 1,00 mm |
| Suitable for cable tray | <input checked="" type="checkbox"/> |
| Suitable for mesh cable tray | <input type="checkbox"/> |
| Suitable for cable ladder | <input checked="" type="checkbox"/> |
| Suitable for maintaining electrical function | <input type="checkbox"/> |
| Rustproof steel, pickled | <input type="checkbox"/> |