

Technical data sheet

Cover with turn buckle

Item no. 6052150

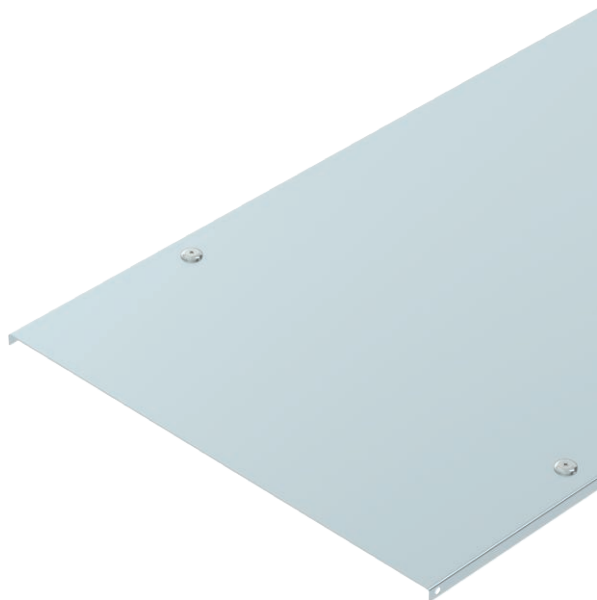

Cover for cable trays and cable ladders with turn buckles.

Transverse bead from 500 mm width.

When using covers outdoors, additional measures against the influence of wind must be taken.



St Steel

FS Strip galvanised

Master data

Item no.	6052150
Type	DRL 150 FS
Description 1	Cover with turn buckle
Manufacturer	OBO
Dimension	150x3000
Material	Steel
Material symbol	St
Surface	Strip galvanised
Surface to DIN	DIN EN 10346
Surface symbol	FS
Smallest sales unit (VG)	3 m
Weight	141,67 kg/100 m

Technical data

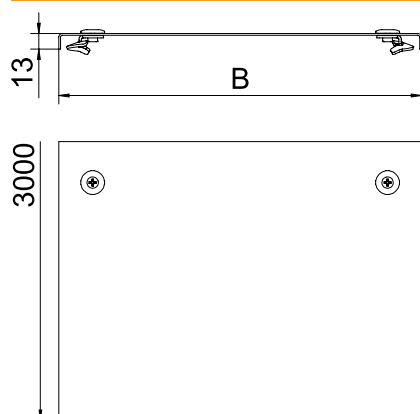

Length	3.000,00 mm
Width	150,00 mm
Side height	35,00 mm
Dimension B	150,00 mm
Dimension H	15,00 mm
Number of turn buckles	6,00 pc.
Fastening type	Turn buckle
Plate thickness	1,00 mm
Suitable for cable tray	<input checked="" type="checkbox"/>
Suitable for mesh cable tray	<input type="checkbox"/>
Suitable for cable ladder	<input checked="" type="checkbox"/>
Suitable for maintaining electrical function	<input checked="" type="checkbox"/>
Rustproof steel, pickled	<input type="checkbox"/>