

Technical data sheet

Ceiling bracket

Item no. 6363907

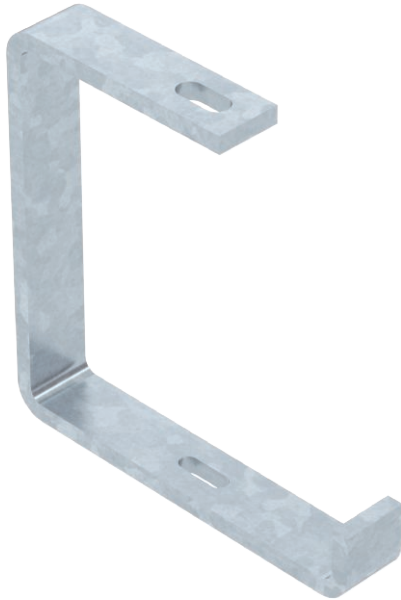

Suspension bracket for cable support systems.



- St** Steel
- FT** Hot-dip galvanised

Master data

Item no.	6363907
Type	AHB 150 FT
Description 1	Suspension bracket
Description 2	flat steel
Dimension	B150mm
Material	Steel
Material symbol	St
Surface	Hot-dip galvanised
Surface to DIN	DIN EN ISO 1461
Surface symbol	FT
Smallest sales unit (VG)	1 Piece
Weight	87,00 kg/100 pc.

Technical data

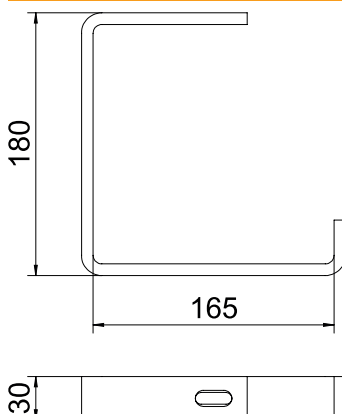

Width	181,00 mm
Height	180,00 mm
Dimension B	165,00 mm
Version	Suspension bracket (C clamp)
Tray fastening	Screw-on
F in ceiling for width	0,60 kN
for threaded rod	150,00 - 150,00 mm
For metric threaded rod	M10
Suitable for tray/ladder width	10
Suitable for maintaining electrical function	150,00 mm
Suitable for cable tray	<input type="checkbox"/>
Suitable for cable ladder	<input checked="" type="checkbox"/>
Suitable for mesh cable tray	<input type="checkbox"/>
Hole diameter	<input type="checkbox"/>
Material thickness	11,00 mm
Adjustable	8,00 mm
	<input type="checkbox"/>

Technical data sheet

Ceiling bracket

Item no. 6363907

