

According to the IEC/EN standards  
**IEC 60364-4-44**  
**IEC 60364-5-53**  
surge protection is  
frequently mandatory.



# Lightning protection guide

Support in the planning of lightning  
and surge protection systems

2nd revised edition 2019

Building Connections



## Foreword

OBO Bettermann is one of the world's most experienced manufacturers of lightning and surge protection systems. For almost 100 years, OBO has been developing and producing standard-compliant lightning protection components. The rise of the modern computer began in the 1970s, with the invention of the electronic typewriter. At this time, OBO reacted with the V-15 surge voltage arrester and set new standards. Countless new products over the years, such as the first connectable type 2 surge protection device with VDE test mark, or the first connectable type 1 lightning current arrester with carbon technology, laid the foundation for the uniquely comprehensive product range that we offer today.

OBO was the first manufacturer to publish a guide to lightning protection – way back in the 1950s. This original guide focused on external lightning protection and earthing systems. Since then, further information has been steadily added to the “planner section” of the guide to include information on surge protection for energy, data and MCR systems. The motto in the picture – BLITZSCHUTZ GIBT SICHERHEIT (“LIGHTNING PROTECTION PROVIDES SAFETY”) – is as relevant today as it ever was, with external lightning protection still providing valuable passive fire protection in the event of a direct lightning strike.

Just like its predecessors, this edition of the lightning protection guide offers assistance in installing professional lightning protection systems in line with the very latest standards.

OBO's research and development activities received a boost in 1996 with the opening of the new BET research centre, home to one of the largest lightning surge current generators in Europe and numerous testing units. Today, lightning and surge protection components, lightning protection structures and surge protection devices are put through their paces in the BET Test Centre by highly qualified specialists in accordance with the relevant standards.



*From our archives: a cartoon from 1958. The caption reads: "Lightning protection provides safety."*

OBO supports and drives the development of national and international lightning protection standards of the series IEC 62305.

Through its membership of VDB (Association of German Lightning Protection Companies) and the VDE Committee for Lightning Protection and Research, OBO is always up to date with the latest insights from the worlds of science and lightning protection practice.

Establishing partnerships with customers is a top priority for OBO, and OBO staff are available to support customers in all aspects of their projects, including products, installation and planning advice. Through its policy of continuous improvement, OBO creates fertile conditions for the development of new products and documents. This guide aims to provide practical assistance. We are always more than glad to incorporate suggested improvements.

We would like to wish all readers and lightning protection specialists the greatest possible satisfaction as they go about their important task of keeping people, buildings and equipment safe from lightning currents and electrical surges.

Andreas Bettermann

OBO Bettermann GmbH & Co.KG  
[www.obo.de](http://www.obo.de)

# Contents

<b>Chapter 1</b> <b>General introduction</b>	7
<b>Chapter 2</b> <b>The external lightning protection system</b>	55
<b>Chapter 3</b> <b>The internal lightning protection system</b>	175
<b>Chapter 4</b> <b>Testing, maintenance and documentation</b>	271
<b>Chapter 5</b> <b>Brief glossary of surge protection</b>	279



# Protected

**The “Protected to the power of four” principle:**

The matched, safe and tested lightning protection systems from OBO Bettermann protect people, buildings and property. OBO can offer the right selection of products, depending on the application and scope of protection. Surge voltages are a constant risk for buildings and people. Effective protection is only guaranteed when surge voltages are reduced in stages as part of a lightning protection zone concept. Our lightning and surge voltage protection systems are perfectly matched to one another and to the requirements in the different zones – from the air-termination device, which must arrest the full energy of a lightning strike, through to fine power protection, which eliminates the last voltage peaks directly in front of a terminal.

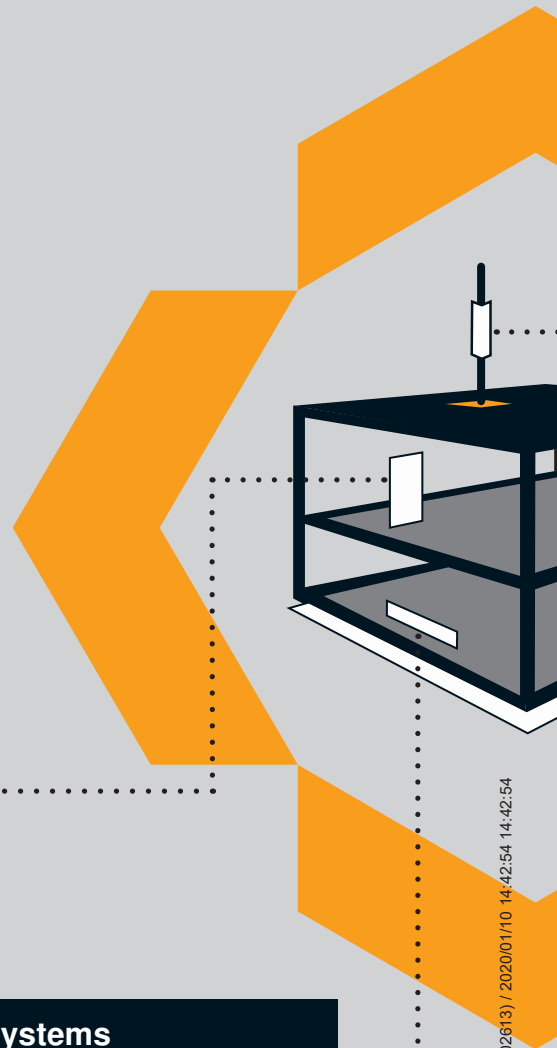

4

**Surge protection systems**

Surge protection systems form a multi-stage barrier which no surge voltage can break through.

According to IEC 60364-4-44 IEC 60364-5-53, surge protection is frequently mandatory

*Lightning protection provides safety!*

*Lightning protection is fire protection through the avoidance of sparks and fire if there is a lightning strike.*

*Surge protection is fire protection through the avoidance of short circuits if there is a lightning strike.*

## Air-termination and conductor systems

Direct lightning strikes with energy of up to 200,000 A are reliably intercepted by air-termination devices and conducted into an earthing system through the conductor systems.

IEC/EN 62305  
+  
State and model building regulations require lightning protection

## 2

### Earthing systems

If the conducted lightning current reaches the earthing system, then approximately 50 per cent of the energy is passed into the ground, while the other half is distributed via the equipotential bonding system.

IEC/EN 62305  
+  
DIN 18014  
require  
foundation earth electrodes

### 3

### Equipotential bonding systems

These form the interface between external and internal lightning protection. They ensure that dangerous potential differences do not come about in the building.

IEC/EN 60364-1  
requires protection against  
electric shocks

# 1

Every year, lightning strikes and surge voltages put at risk – or cause harm to – people, animals and property. Damage to property is becoming an ever greater problem as the failure of electronic devices can cause financial loss in industry and inconvenience for individuals. Building regulations mean that it is a legal requirement today that buildings incorporate personal safety and preventive fire protection elements. The work of public agencies, such as the police, ambulance and fire services, is also particularly worthy of protection.

Whether a lightning protection system is needed in a given situation can be determined on the basis of the latest standards. Alternatively, the cost of damage to equipment can be compared with the cost of fitting a protection system that would prevent that damage from occurring. The latest standards also explain in technical terms how protective measures should be executed. Certain specialised components are required for installing a lightning protection system.

# Chapter 1: General introduction

1	General introduction	9
1.1	Lightning	10
1.1.1	How lightning is formed	11
1.1.1.1	Types of thunderstorm	11
1.1.1.2	Charge separation	11
1.1.1.3	Charge dispersion	12
1.2	Risks posed by lightning discharges	13
1.2.1	Risk to humans	13
1.2.2	Risk to buildings and equipment	14
1.2.2.1	Transient surges	15
1.2.2.2	Lightning surges	15
1.2.2.3	Effects of surges	15
1.3	Sources and causes of damage according to standards	15
1.4	Test currents and simulated surge voltages	21
1.5	Legal regulations defining what lightning protection is required	22
1.5.1	Lightning and surge protection standards	23
1.5.2	Hierarchy of standards: international/European/national	25
1.5.3	Latest German national lightning protection standards	25
1.5.4	Construction law	26
1.5.4.1	Construction law protection aims	28
1.5.4.2	Building classes (using the example of Germany)	28
1.5.4.3	Special constructions	30
1.5.4.4	Four pillars of fire protection	31
1.5.5	Protection class recommendation for preventive fire protection for structures	33
1.5.6	Responsibility of the erection engineer	41
1.5.7	Responsibility of the operator	41
1.6	Financial implications of lightning and surge voltage damage	42
1.7	Lightning protection risk analysis and categorisation by lightning protection class	43
1.7.1	Frequency of lightning strikes by region	45
1.7.2	Equivalent interception area	45
1.7.3	Estimation of the damage risk	46
1.7.4	Empirical lightning protection classification of buildings	47
1.7.5	Cost-effectiveness calculation for lightning protection systems	47
1.7.5.1	Costs without lightning protection system	47
1.7.5.2	Costs with lightning protection system	47
1.7.5.3	Comparing the costs of lightning damage in buildings with and without a lightning protection system	47
1.8	Laboratory testing of lightning and surge protection components	49
1.8.1	Standard-compliant testing	50
1.8.2	Certification	51
1.9	Components of a lightning and surge protection system	52
1.9.1	Surge protection as a part of equipotential bonding	53



*"The safest way to protect yourself against lightning in a house is the erection of a lightning arrester, which carries the electrical matter from the thundercloud safely down into the earth without allowing it to touch even a single beam of the house."*

Joseph Kraus' "Catechism of Lightning", 1814



## 1. General introduction

Lightning is a naturally occurring spark discharge or short-lived electric arc. Lightning discharges can take place from one cloud to another, or between a cloud and the ground. Lightning – one of the "electrometeors" – generally occurs during thunderstorms, where it is accompanied by thunder. Lightning involves an exchange of electric charges (electrons or gas ions), in other words, electric currents flow. Depending on the polarity of the electrostatic charge, lightning can alternatively start from the ground.

Some 90% of all lightning discharges between a cloud and the ground are negative ground-to-cloud strikes. Here, the lightning begins in an area of negative charge in the cloud and spreads to the positively charged ground.

However, the vast majority of discharges take place within clouds, or from one cloud to another.

NASA has measured the annual global frequency of lightning over the period 1995 to 2003. The local values obtained by NASA can be used to determine the annual number of lightning strikes per km<sup>2</sup> even for countries that do not have their own information on numbers of lightning impulses. For risk assessments according to IEC/EN 62305-2, it is recommended that these values are doubled.

*The less common types of discharge are:*

- *Negative ground-to-cloud lightning*
- *Positive cloud-to-ground lightning*
- *Positive ground-to-cloud lightning*

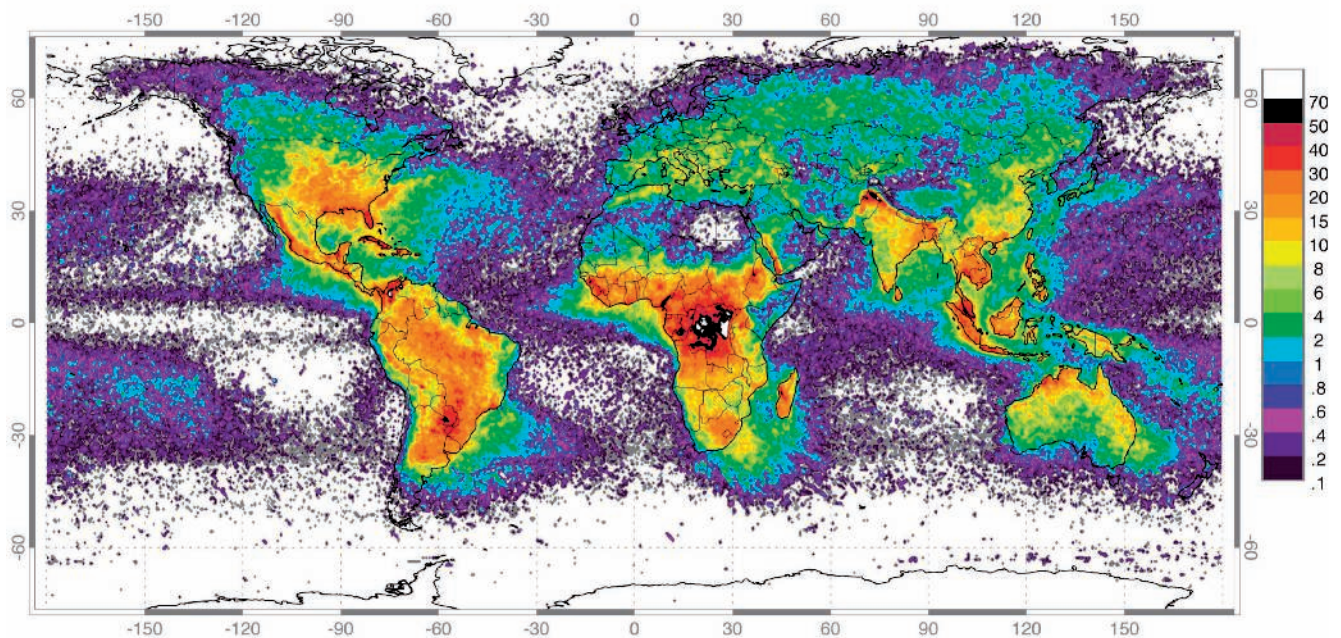

Annual number of lightning strikes per km<sup>2</sup> between 1995 and 2003  
([www.nasa.gov](http://www.nasa.gov))

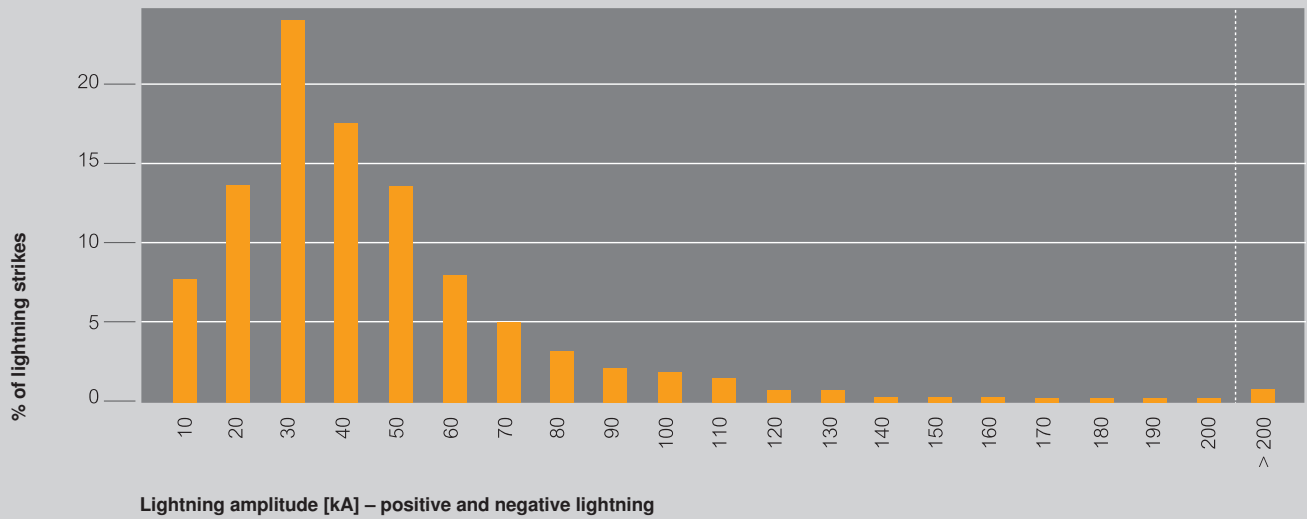

Frequency of lightning by amplitude

## 1.1 Lightning

Lightning and surge voltages endanger people and assets. Lightning strikes Germany around two million times a year, and that figure is rising. Discharges occur in both rural and densely populated areas, endangering people, buildings and technical equipment. Several hundred million euros of damage is done each year, especially as a result of electrical surges.

A lightning protection system consists of both external and internal lightning protection measures. It protects people from injury, structures from damage and electrical equipment from failure due to surge voltages.

### Key data about lightning:

- 1,500,000,000 lightning strikes annually per year
- 2,000,000 lightning strikes in Germany per year
- 450,000 instances of surge voltage damage in Germany per year
- Surge voltage damage can occur over a radius of up to 2 km from the location of the lightning strike
- The majority of lightning strikes are of a magnitude between 30 and 40 kA

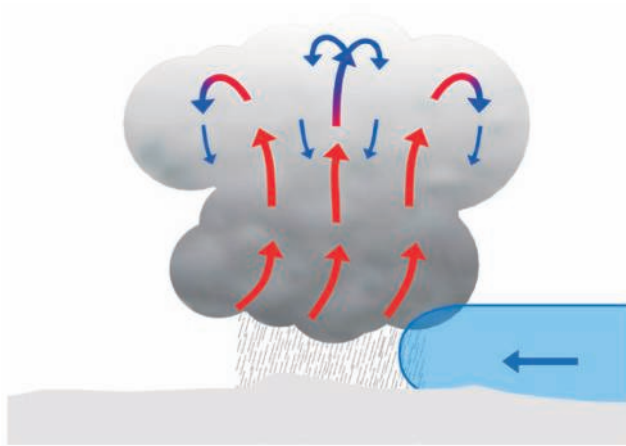

A cold front

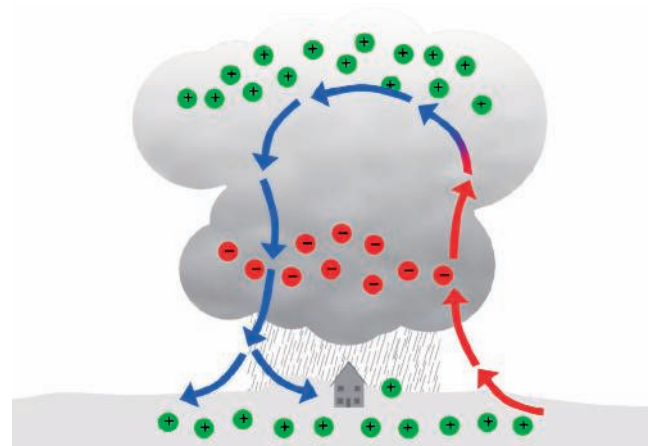

How lightning forms – negative and positive charges

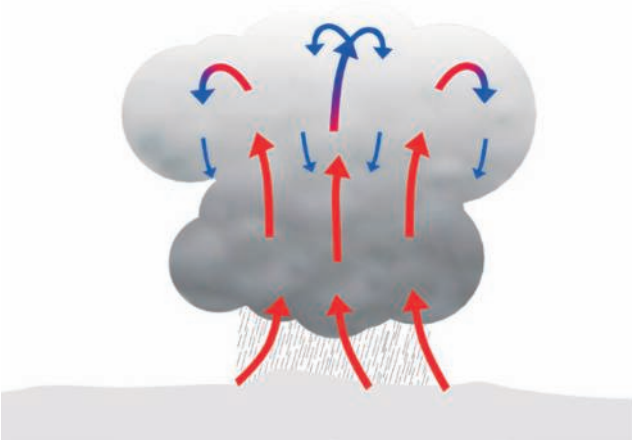

A heat thunderstorm

### 1.1.1 How lightning is formed

Storm fronts can occur when clouds expand to heights of up to 15,000 metres.

#### 1.1.1.1 Types of thunderstorm

Cold front thunderstorms develop when humid warm air meets a front of cold air. Heat thunderstorms are produced by a combination of intense solar radiation and moist, warm air rising rapidly to great heights.

#### 1.1.1.2 Charge separation

When warm, damp air rises, the moisture in the air condenses and, at higher altitudes, ice crystals form. Strong up-winds of up to 100 km/h cause the light ice crystals to move to the upper area and the hail particles to the lower area. Impact and friction cause charge separation.

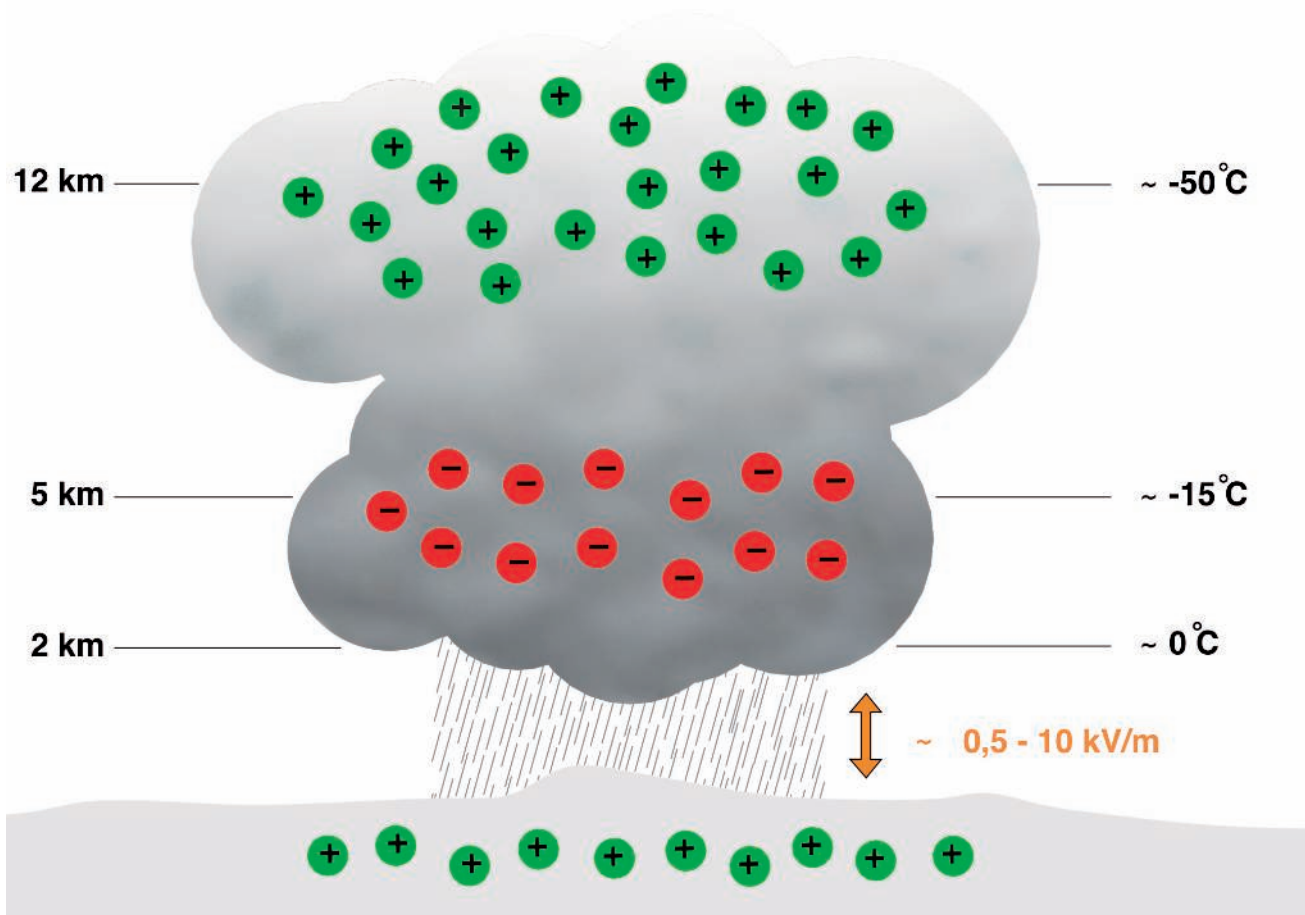

Charge distribution in a cloud

### 1.1.1.3 Charge dispersion

Studies have proved that the sleet falling down (area warmer than  $-15\text{ }^{\circ}\text{C}$ ) has a negative charge and the ice crystals being thrown upwards (area colder than  $-15\text{ }^{\circ}\text{C}$ ) have a positive charge. The light ice crystals are carried into the upper areas of the cloud by the up-wind and the sleet falls to the central areas of the cloud.

#### Typical charge distribution:

- Positive in the upper part, negative in the middle part, and weakly positive in the lower part.
- The area near the ground also has a positive charge.
- The field strength required to trigger lightning is dependent on the insulation ability of the air and is between 0.5 and 10 kV/m.

## 1.2 Risks posed by lightning discharges

Our dependency on electrical and electronic equipment continues to increase, in both our professional and private lives. Data networks in companies or emergency facilities such as hospitals and fire stations are lifelines for an essential real time information exchange. Sensitive databases, e.g. in banks or media publishers, need reliable transmission paths.

It is not only lightning strikes that pose a latent threat to these systems. More and more frequently, today's electronic aids are damaged by surge voltages caused by remote lightning discharges or switching operations in large electrical systems. During thunderstorms too, high volumes of energy are instantaneously released. These voltage peaks can penetrate a building through all manner of conductive connections and cause enormous damage.

### 1.2.1 Risk to humans

When lightning hits buildings, trees or even the ground itself, the lightning current enters the ground and a so-called potential funnel forms. The greater the distance from the point where the current enters the ground, the lower the electrical potential in the ground. The difference in potential produces a step voltage that puts people and animals at risk of electric shock. In buildings fitted with lightning protection systems, the lightning current causes a voltage drop at the earthing resistance. All metal components in and on the building must be connected with the equipotential bonding system to rule out the risk of high contact voltages. On the ground near the building, step voltages pose a further risk. If a person touches the lightning protection system, they are at risk of harm due to the large contact voltage.

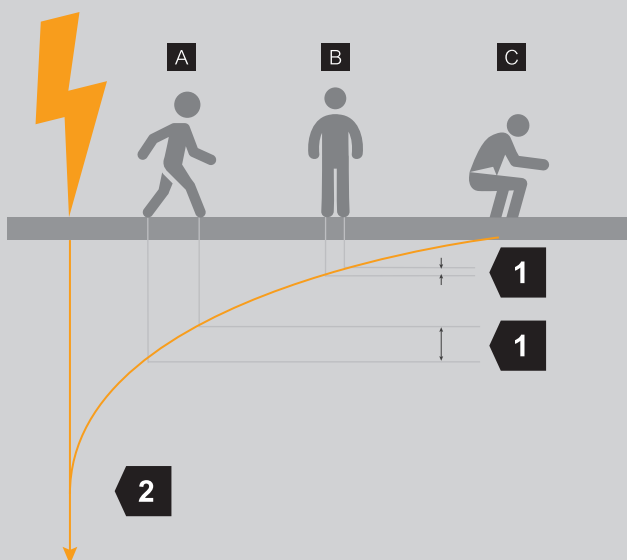

<b>1</b>	Step voltage $U_s$
<b>2</b>	Potential gradient area
<b>A</b>	Close to the point of strike/beside the down-conductor, the step voltage (1) is high.
<b>B</b>	The step voltage decreases with distance away from the point of lightning impact.
<b>C</b>	Out in the open, a crouching position provides protection against direct lightning impact.

Step voltage and potential funnel formed when lightning strikes

### 1.2.2 Risk to buildings and equipment

Buildings and equipment are at risk not just from direct lightning strikes, but also from the surges that can occur up to two kilometres away from a lightning strike. Surges are several times (factor:  $K/\dot{U}_S$ ) above the permissible mains voltage. If the electric strength ( $\dot{U}_r/V$ ) of an electrical system is exceeded, this will lead to malfunctions or even permanent destruction.

Weak and frequent permanent surges are triggered by high-frequency interference and line disruptions. In these cases, the sources of interference must be removed or suitable line filters fitted. Suitable lightning and surge protection systems are needed to protect against energy-rich switching or lightning surges in buildings and equipment.

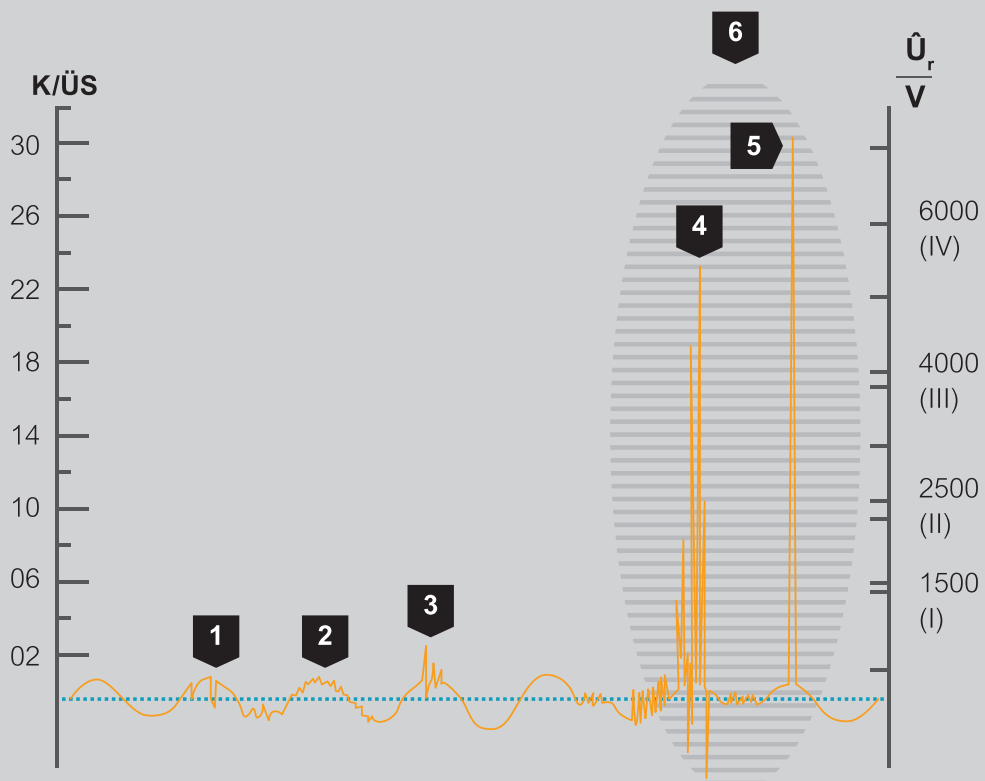

1	Voltage dips of various duration
2	Harmonics caused by slow and rapid voltage fluctuations
3	Transient surge voltages
4	Switching surges
5	Lightning surges
6	Range within surge protective devices are used

Types of surge voltage

### 1.2.2.1 Transient surges

Transient surges are voltage increases lasting for a matter of microseconds but whose magnitude is several times that of the mains voltage. Permanent surges caused by impermissible conditions in the mains network are not considered as transient surges.

#### Switching surges

Switching surges can arise from various sources, e.g. switching operations involving large inductive loads such as motors. As a rule, switching surges amount to twice to three times the operating voltage.

#### Induced surge voltages

Induced voltage peaks in building installations and energy or data supply cables can also reach many times the nominal operating voltage and cause the immediate failure of the systems.

### 1.2.2.2 Lightning surges

The largest voltage peaks in the low-voltage consumer network are caused by lightning discharges. Lightning surges can sometimes reach 100 times the nominal voltage value and transport a high energy content. When a direct strike hits the external lightning protection system or a low-voltage exposed cable, this usually causes – without internal lightning and surge protection – damage to the insulation and total outage of the connected consumers.

### 1.2.2.3 Effects of surges

Energy-rich lightning currents often cause the instantaneous destruction of unprotected systems. In the case of small surges, on the other hand, failures often occur only after a time delay as they accelerate the aging process of the components in the affected devices, causing them insidious damage. A number of different protection measures are required. These depend on the exact cause and/or impact point of the lightning discharge.



## 1.3 Sources and causes of damage according to standards

For the purposes of the risk analysis according to IEC/EN 62305-2, lightning strikes are assigned to one of four possible “sources of damage” (S1-S4). A lightning strike can lead to three possible sources of damage (D1-D3). The damage/loss is then categorised according to four different types of damage (L1-L4).

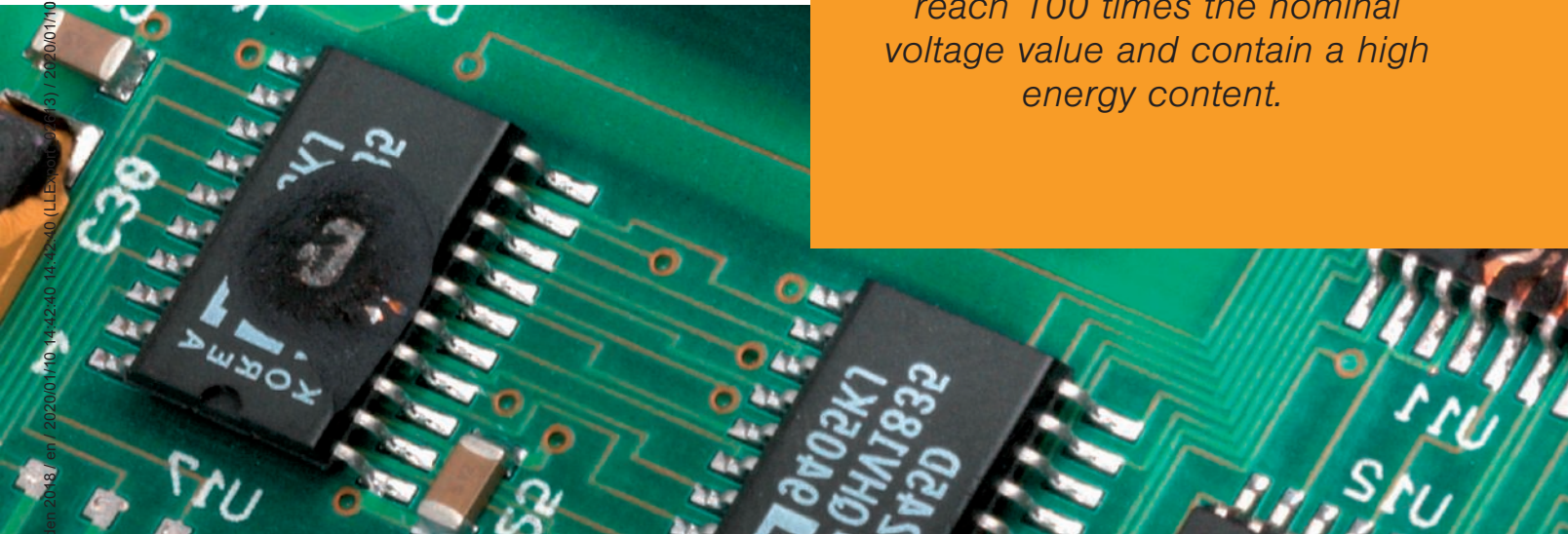
*Lightning surges can sometimes reach 100 times the nominal voltage value and contain a high energy content.*

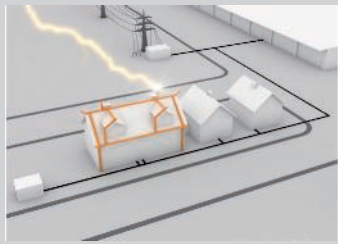
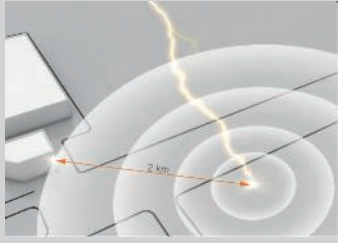
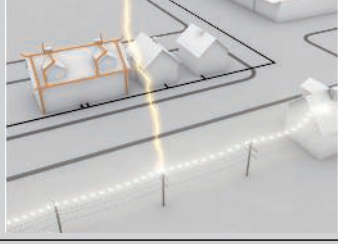

*Circuit board destroyed by a surge*

Impact point	Example	Source of damage	Type of damage	Type of loss
Structure		S1	C1 C2 C3	D1, D4 D1, D2, D3, D4 D1, D2, D4
Ground near a structure		S2	C3	D1, D2, D4
Service connected to the structure		S3	C1 C2 C3	D1 D1, D2, D3, D4 D1, D2, D4
Ground near a service		S4	C3	D1, D2, D4

Risk analysis according to IEC 62305-2

<b>C1</b>	Electric shock to life forms due to contact and step voltages
<b>C2</b>	Fire, explosion and mechanical and chemical impact due to physical effects of lightning discharge
<b>C3</b>	Destruction of electrical or electronic systems by surge voltages
<b>D1</b>	Injury to or death of people
<b>D2</b>	Loss of services to the public
<b>D3</b>	Loss of irreplaceable cultural treasures
<b>D4</b>	Financial losses



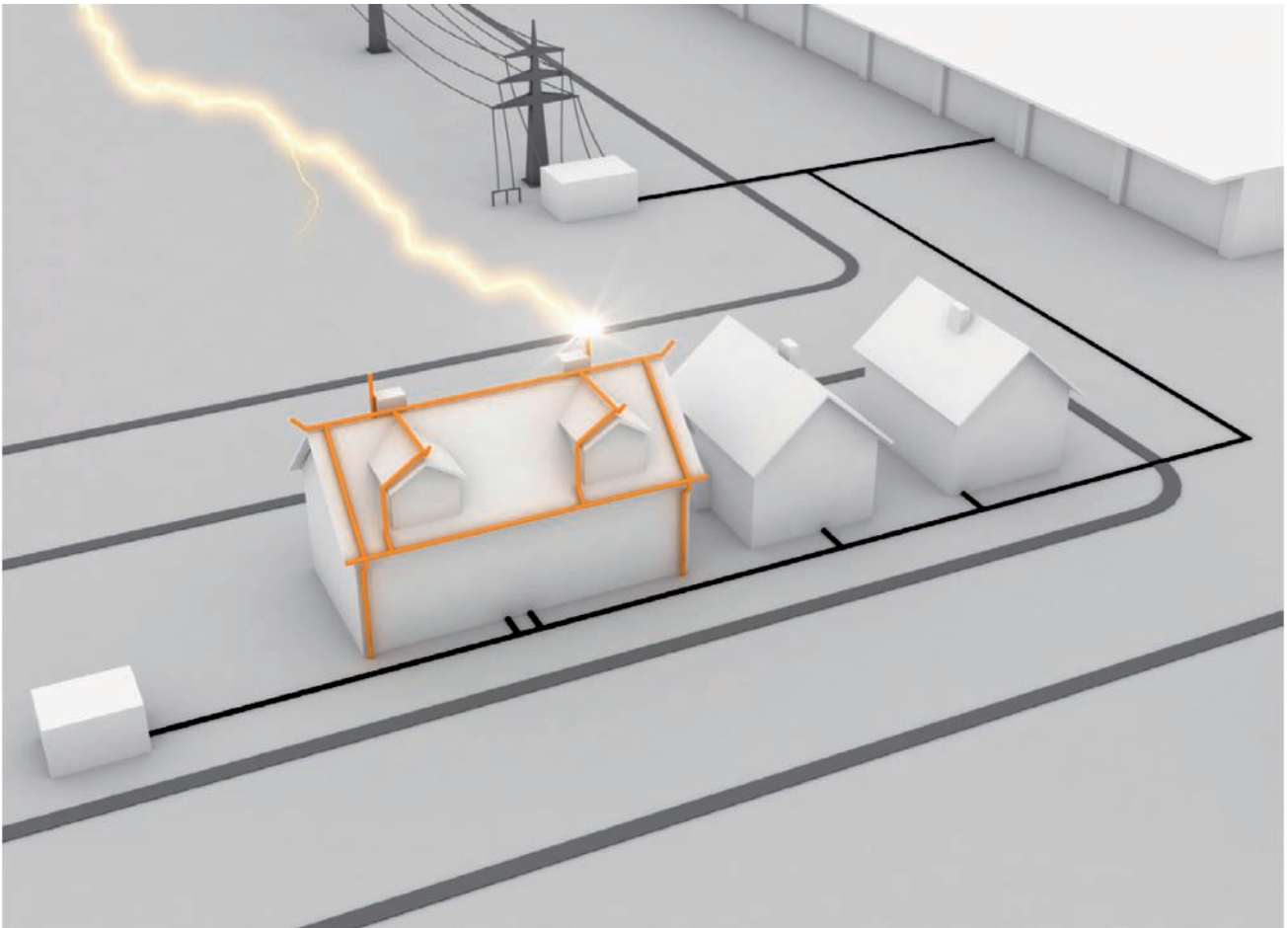

*Danger: direct lightning strike*

### **S1: Direct lightning strike into a building**

If a lightning strike hits the external lightning protection system or earthed roof structures capable of carrying lightning current (e.g. rooftop antennas), the lightning energy can be safely discharged to earth potential. But a lightning protection system alone is not enough: due to its impedance, the building's entire earthing system is raised to a high potential. This potential increase causes transmission of the lightning current over the building's earthing system and also over the power supply systems and data cables to the adjacent earthing systems (adjacent building, low-voltage transformer). A direct lightning strike poses a risk of loss of human life, public services (telephone), cultural treasures (museums, theatres) and economic goods (property). The lightning protection system protects the building and people from direct lightning impulses and fires.

*If a lightning strike hits the external lightning protection system or earthed roof structures capable of carrying lightning current, the lightning energy can be safely discharged to earth potential.*

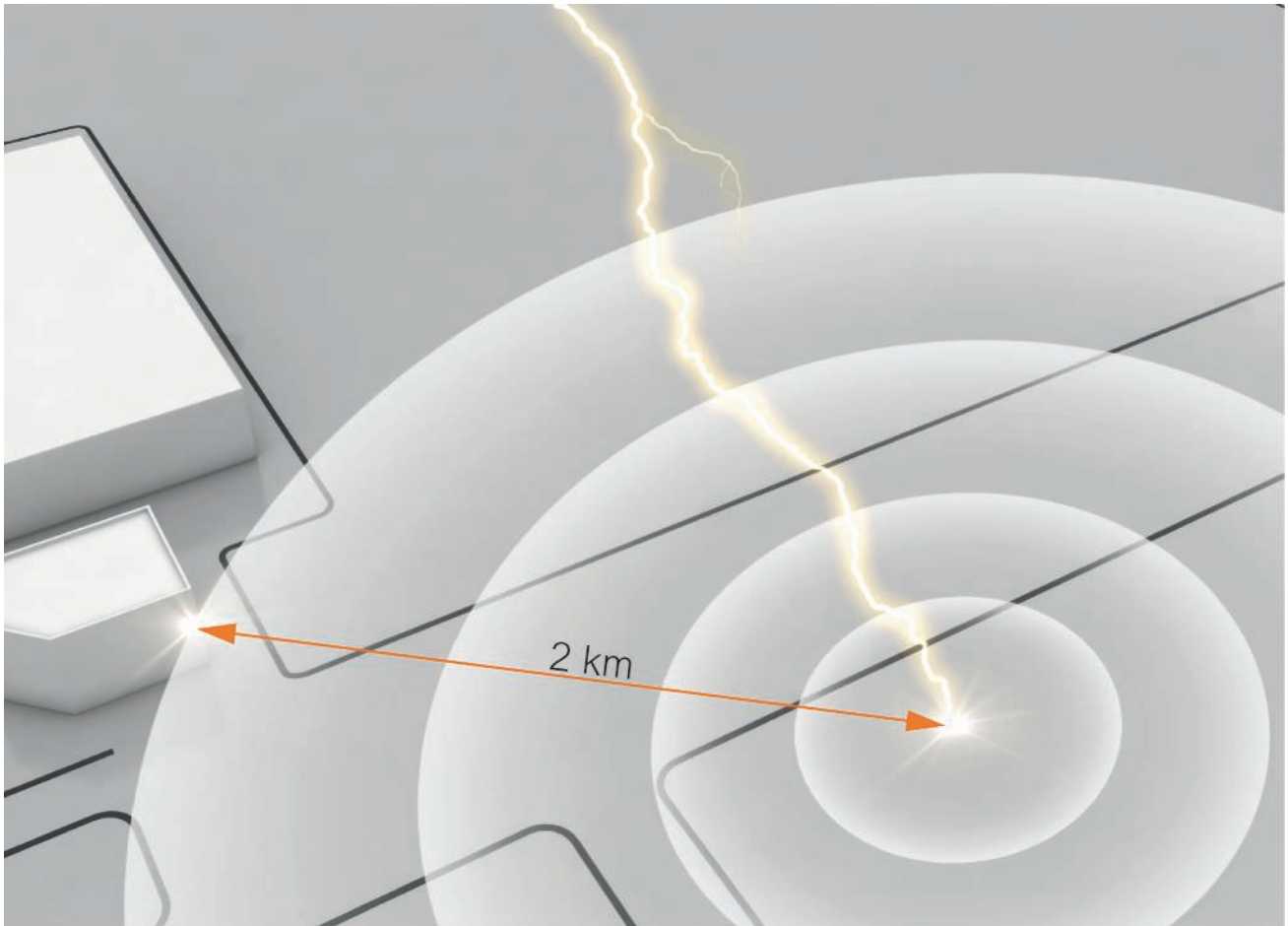

*Danger: surge pulse due to inductive and galvanic coupling*

**S2: Lightning strike near a building and couplings over a radius of up to 2 km**

A local lightning strike creates additional high magnetic fields, which in turn induce high voltage peaks in cable systems. Inductive or galvanic couplings can cause damage within a radius of up to 2 km around the lightning impact point. Surge voltages interfere with or destroy electrical and electronic systems.

Lightning and surge protection devices protect against uncontrolled arcing (sparks) and the resulting fire risk.

*A local lightning strike creates additional high magnetic fields, which in turn induce high voltage peaks in cable systems.*

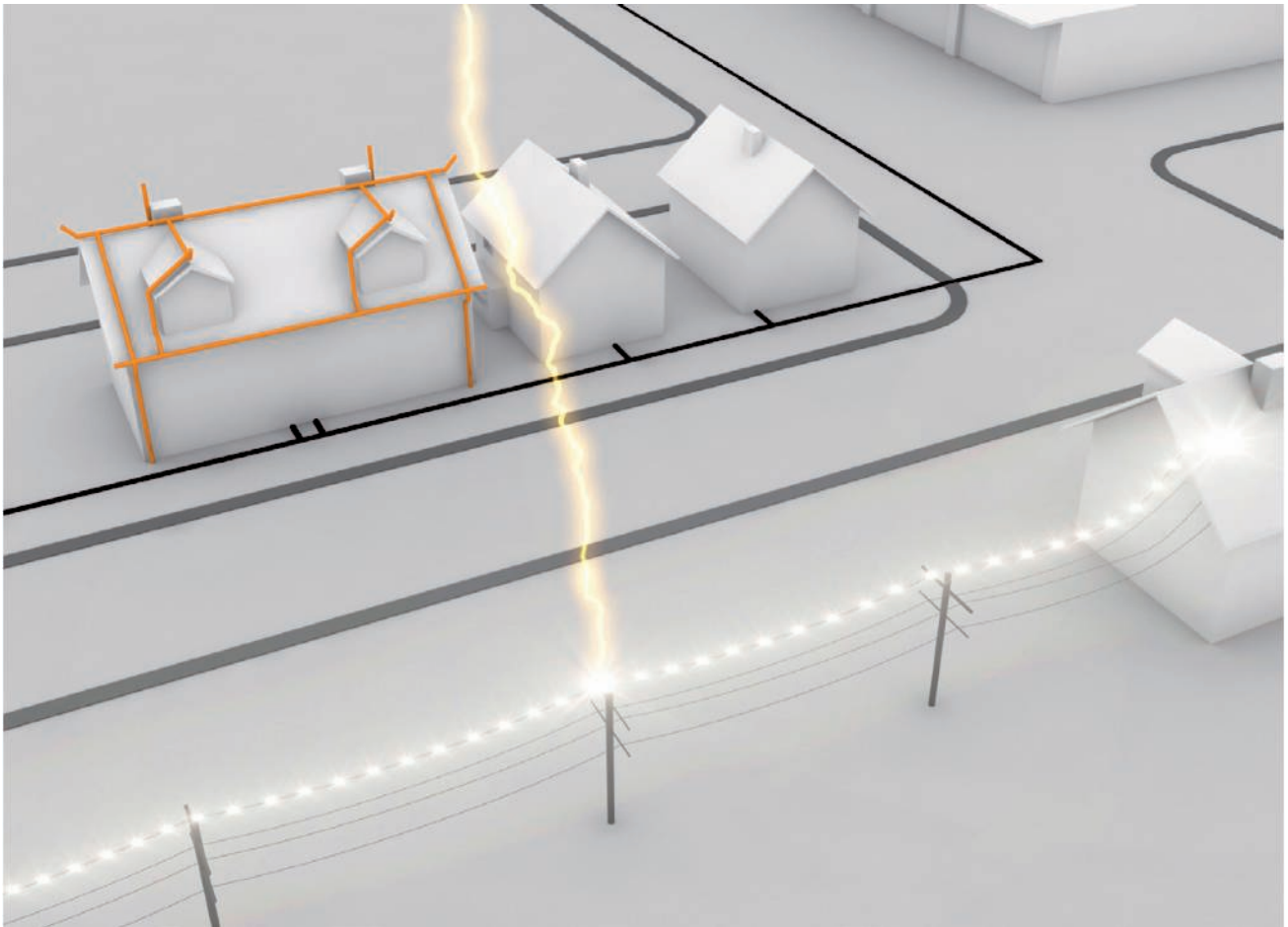

*Danger: lightning impulse and partial lightning currents along wires*

### **S3: Direct lightning strike into a supply line**

A direct lightning strike into a low-voltage or data cable can couple high partial lightning currents in an adjacent building. Electrical equipment in buildings at the end of the low-voltage cables are at particular risk of damage caused by surges.

The degree of risk depends on how the lines are routed. Distinctions are made between exposed and underground wires, and according to the way in which the shielding is connected to the equipotential bonding. Suitable lightning and surge protection devices are used to compensate the energy from the lightning pulse at the entry to the building.

*A direct lightning strike into a low-voltage exposed cable or data cable can couple high partial lightning currents in an adjacent building.*

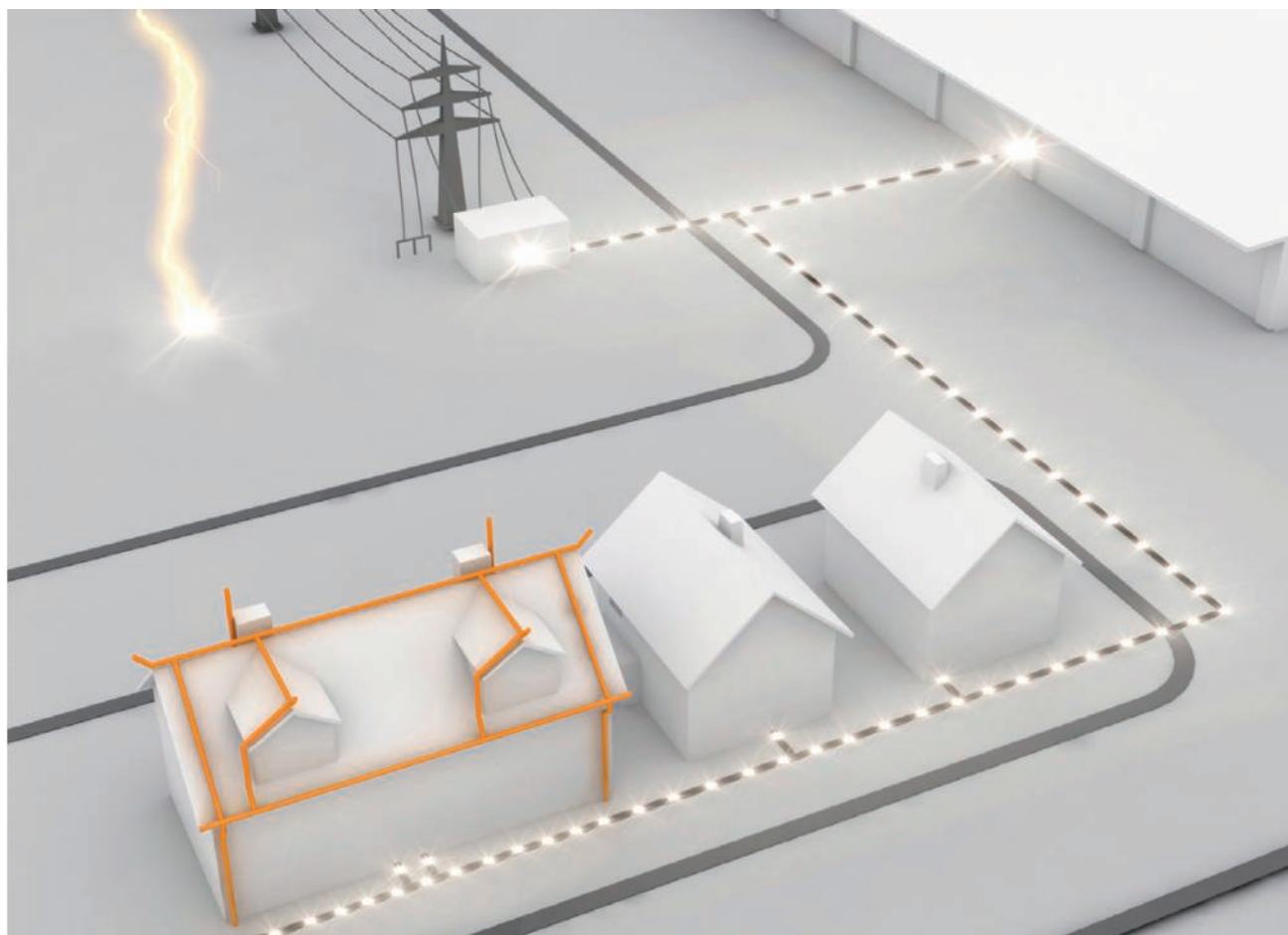

*Danger: galvanically coupled and line-carried surge voltage*

#### **S4: Direct lightning strike by a supply line**

The proximity of the lightning strike induces surge voltages in cables. Switching surges are additionally caused by switch-on and switch-off operations, by the switching of inductive and capacitive loads, and by the interruption of short circuit currents. Particularly when production plants, lighting systems or transformers are switched off, electrical equipment located in close proximity can be damaged.

*Switching surges and induced surge voltages in lines account for the majority of cases of damage.*

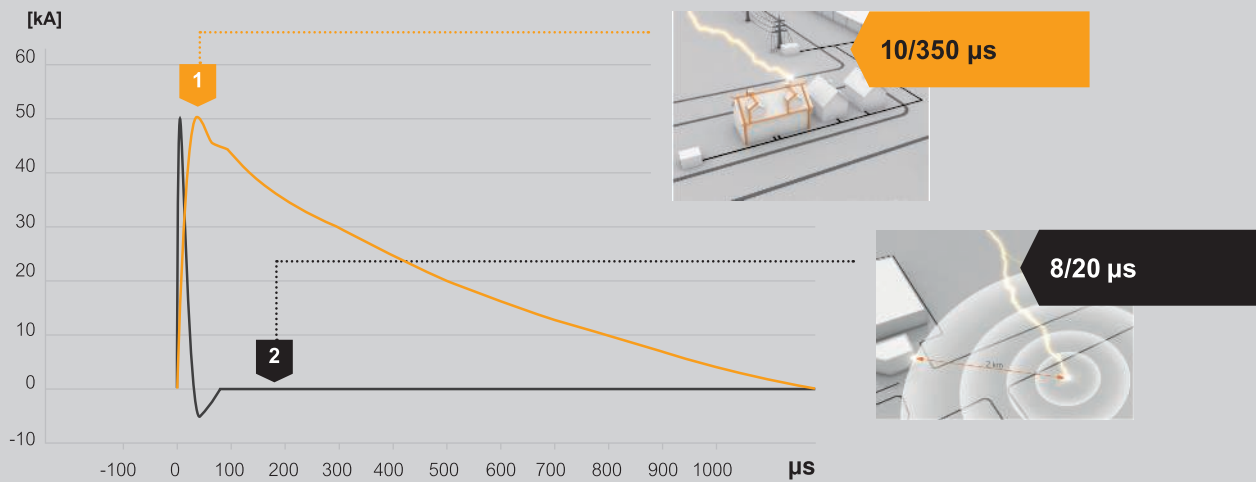

<b>1</b>	Pulse shape 1: Direct lightning strike, 10/350 $\mu\text{s}$ simulated lightning pulse
<b>2</b>	Pulse shape 2: Remote lightning strike or switching operation, 8/20 $\mu\text{s}$ simulated current pulse (surge voltage)

### Types of pulse and their characteristics

## 1.4 Test currents and simulated surge voltages

High lightning currents can flow to the ground during a storm. If a building with external lightning protection receives a direct hit, a voltage drop occurs on the earthing resistance of the lightning protection equipotential bonding system, which represents a surge voltage against the distant environment.

### Example:

- Lightning current (i): 100 kA
- Earthing resistance (R): 1  $\Omega$
- Voltage drop (u):  
 $R \times i = 1 \Omega \times 100 \text{ kA} = 100,000 \text{ V}$

### Conclusion:

The voltage between the earthing resistance and the remotely earthed network increases by 100 kV.

This rise in potential poses a threat to the electrical systems (e.g. voltage supply, telephone systems, cable TV, control cables, etc.) that are routed into the building. Suitable test currents for testing different lightning and surge protectors have been defined in national and international standards.

### Direct lightning strike: Pulse shape 1

Lightning currents that can occur during a direct lightning strike can be imitated with the surge current of waveform 10/350  $\mu\text{s}$ . The lightning test current imitates both the fast rise and the high energy content of natural lightning. Type 1 lightning current arresters and external lightning protection components are tested using this pulse.

### Remote lightning strikes or switching operations: Pulse shape 2

The surges created by remote lightning strikes and switching operations are imitated with test impulse 8/20  $\mu\text{s}$ . The energy content of this impulse is significantly lower than the lightning test current of surge current wave 10/350  $\mu\text{s}$ . Surge arresters of type 2 and type 3 are impacted with this test impulse.

The area under the current-time curve for surge currents indicates the amount of charge. The charge of the lightning test current of waveform 10/350 roughly corresponds to 20 times the charge of a surge current of waveform 8/20 with the same amplitude.

<b>1. Legislation</b>	Examples: German Constitution, regional building regulations for public buildings and meeting places
<b>2. Ordinances</b>	Example: Technical Rules for Industrial Safety (TRBS) of the German Federal Institute for Occupational Safety and Health
<b>3. Specifications</b>	Example: Accident prevention regulations
<b>4. Technical rules</b>	Example: IEC/EN 62305
<b>5. Contracts</b>	Example: Insurers' guidelines, e.g. VDS 2010



List of applicable documents shown in order of increasing legal force

## 1.5 Legal regulations defining what lightning protection is required

What lightning protection is required depends on five factors:

### 1. Legislation

The most important tasks of the legal system are to protect human life and basic social assets (cultural treasures, security of energy supplies, etc.). Lightning protection is demanded by, for example, the German state building regulations for public buildings and meeting places.

### 2. Ordinances

An ordinance is passed not by national parliaments but by national executive bodies, e.g. the Technical Rules for Industrial Safety (TRBS) published by the German Federal Institute for Occupational Safety and Health. For example, lightning protection is referred to in part 3 of TRBS 2152 as a means of preventing the ignition of dangerous explosive atmospheres.

### 3. Specifications

Under specifications such as the German “accident prevention regulations”, all companies are required to adhere to certain occupational safety and health requirements in the workplace.

*Every owner or operator is responsible for the safety of their own plant. It is in their interest to keep their plant in operation, so they should check what the cost of failure would be.*

### 4. Technical rules

Standards and technical rules present methods and technical solutions to ensure adherence to the safety standards specified in the legislation. The most important standard for lightning protection is IEC 62305. IEC 60364-4-44 describes a risk analysis for determining what surge protection devices are required. In Germany, surge protection has been mandatory since October 2016.

### 5. Contracts

Insurance companies have drawn up guidelines on the basis of damage and accidents that have been observed in the past. Objects for which lightning and surge protection measures are obligatory are listed in e.g. VdS 2010. A relevant excerpt from VDS 2010 can be found in Table 1.5.

### 1.5.1 Lightning and surge protection standards

When planning and executing a lightning protection system, it is necessary to observe all relevant national annexes and take account of any special circumstances or applications and the safety stipulations in the relevant state-specific supplements.

A lightning and surge protection system consists of several systems, each tailored to each of the others. At its most basic, a lightning and surge protection system consists of one internal and one external lightning protection system. These, in turn, can be categorised into the following systems and measures:

- Air-termination systems
- Conductors
- Earthing systems
- Area shielding
- Separation distance
- Lightning protection equipotential bonding

These systems must be carefully selected for the application at hand and used in a coordinated way. Installation of the systems takes place according to various application and product standards. The supplementary sheets of the international IEC guidelines and harmonised European versions of the various country-specific translations often contain additional informative information specific to the country in question.

### Product standards

To ensure that the components can withstand the loads to which they are likely to be exposed in application, they must be checked against the respective product standard for external and internal lightning protection.

*Comprehensive lightning protection can only be achieved through a coordinated approach.*

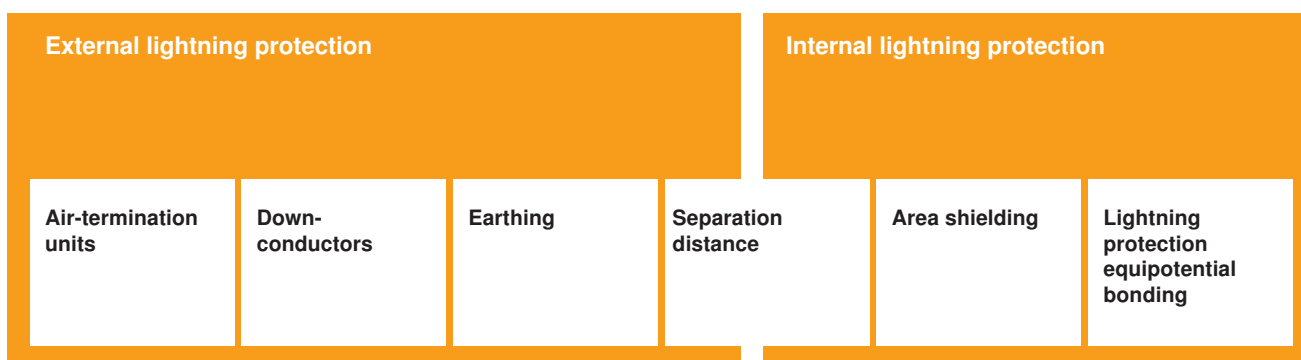

Figure 1 External and internal lightning protection systems

Standard	German supplement	Contents
IEC 62305-1		Protection against lightning – Part 1: General principles
IEC 62305-2		Protection against lightning – Part 2: Risk management
	1	Lightning risk in Germany
	2	Calculation aids for estimating the risk of damage for buildings
	3	Additional information on use of EN 62305-2
IEC 62305-3		Protection against lightning – Part 3: Protection of structures and people
	1	Additional information on use of EN 62305-3
	2	Additional information for building structures
	3	Additional information for the testing and servicing of lightning protection systems
	4	Use of metal roofs in lightning protection systems
	5	Lightning and surge protection for PV power supply systems
IEC 62305-4		Protection against lightning – Part 4: Electrical and electronic systems within structures
	1	Distribution of the lightning current
IEC 0675-6-11		Low-voltage surge protection devices – Part 11: Surge protection devices connected to low-voltage power systems
IEC 60364-5-53		Low-voltage electrical installations – Part 5-53: Selection and erection of electrical equipment – Isolation, switching and control – Clause 534: Devices for protection against surge voltages (ÜSE)
IEC 60364-4-44		Low-voltage electrical installations – Part 4-44: Protection for safety – Protection against voltage disturbances and electromagnetic disturbances – Clause 443: Protection against surge voltages of atmospheric origin or due to switching
IEC 60364-7-712		Requirements for operational premises, special rooms and systems – photovoltaic (PV) power supply systems
IEC 60728-11		Cable networks for television signals, sound signals and interactive services
IEC 61400-24		Wind power plants – Part 24: Lightning protection

Table 1.1: Key lightning protection standards and specifications

Product standards	Contents
IEC 62561-1	Lightning protection system components – Requirements for connection components
IEC 62561-2	Lightning protection system components – Requirements for conductors and earthers
IEC 62561-3	Lightning protection system components – Requirements for spark gaps
IEC 62561-4	Lightning protection system components – Requirements for holders
IEC 62561-5	Lightning protection system components – Requirements for inspection boxes and earther penetrations
IEC 62561-6	Lightning protection system components – Requirements for lightning strike counters
IEC 62561-7	Lightning protection system components – Requirements for earthing enhancing compounds
IEC TS 62561-8	Lightning protection components – Requirements for components for an insulated lightning protection system
IEC 61643-11	Surge protection devices for use in low-voltage power systems – requirements and test methods
IEC 61643-21	Surge protection for use in telecommunications and signalling networks

Table 1.2: Product standards for lightning and surge voltage protection components



### 1.5.2 Hierarchy of standards: international/European/national

When the European standardisation committee (CEN) and the European committee for electrotechnical standardisation (CENELEC) adopt an international standard (IEC) as a European standard (EN), all member states must adopt this standard as a national standard without any changes (e.g. a VDE standard in Germany).

### 1.5.3 Latest international lightning protection standards

The application standards of the series IEC 62305 Part 1 to Part 4 are currently under revision. An Edition 3 is planned for 2020 on an international level. In parallel, this should also see the publication of a 3rd edition on the European level. Should there be the possibility that Edition 3 will see major or important changes to individual lightning protection topics, then this can be seen through a clear reference in the appropriate location in this 2nd revised edition of the OBO lightning protection guide.

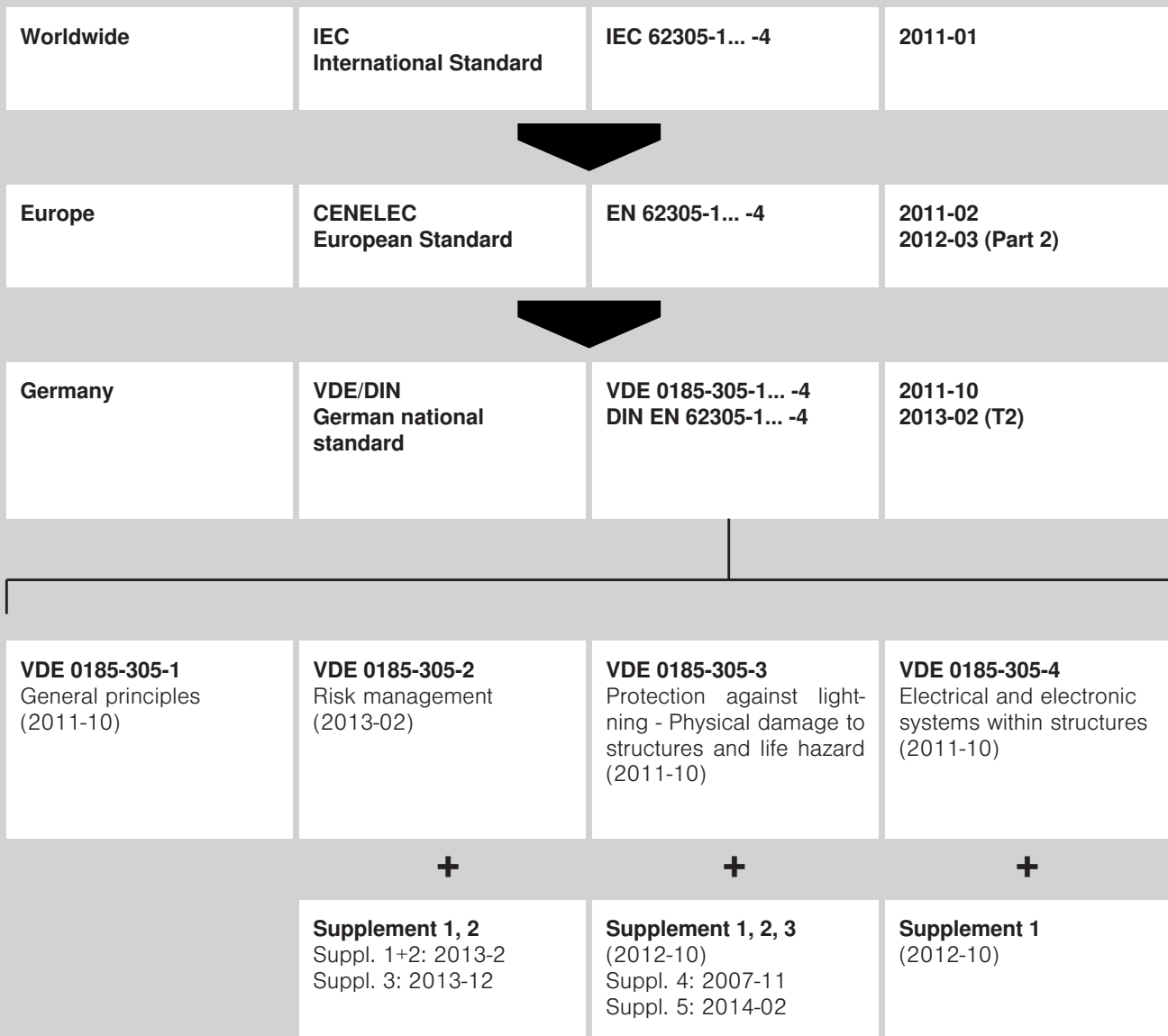

*Hierarchy of lightning protection standards (international/European/national) and current German lightning protection standards: Standardisation and regulations*



Historic city fire: London 1666

#### 1.5.4 Construction law

The catastrophic city fires of the Middle Ages ensured early on that people began to think about the way they built their cities. The closeness of the buildings slowly disappeared and so-called town planning laws were introduced.

Even today, these laws define the distances between buildings, in order to prevent direct spreading of fires. For this reason, only non-combustible materials may now be used for the basic structure of buildings and roofs.

##### Building regulations

In Germany, the model building regulations MBO serve as a basis for the erection of structures and the use of construction products. The state construction regulations in the individual German federal states were created according to the model building regulations, as construction law is the responsibility of the states.

#### Construction law – state law – European law?

The version of the construction laws and the appropriate ordinances vary between the federal states of Germany. This means that there may be differences from state to state. The master cable installation guidelines are also affected: the states have the right to include changes or to apply the suggestion exactly. Therefore, during planning, observe both the location of the construction project and the valid regulations.

Currently, there is no construction law for the whole of Europe. National regulations must be observed. In recent years, the harmonisation of construction products according to the European Construction Products Ordinance has increasingly led to free trading of approved construction products in the European Union.

### General requirements

Construction regulations place basic requirements on a construction system. According to them, a construction project is to be "arranged, erected, modified and maintained in such a way that public safety and order, and in particular life, health and natural requirements for life, are not endangered". This means people, animals and property and their surroundings. Depending on the area concerned, the responsibilities lay with the planner, craftsperson and operator.

### Fire protection in the construction regulations

The first fire protection requirements are, for example, defined in §14 of the German MBO. The building must have been erected as already described in the general requirements, in order to "prevent the creation of fires and the spread of fire and smoke, and allow the rescue of people and animals as well as effective extinguishing measures". This sets three important protection aims.

### Guidelines for electrical installations

Besides the basic national requirements from construction law, there are also the electrical requirements. These are specified by, for example, VDE, ÖVE, KEMA-KEUR and others. However, with regard to fire protection, only the technical systems are described here. Additional construction regulations specify which construction measures must be applied. In Germany, the master cable installation guideline (MLAR) was introduced as a technical construction regulation to the applicable construction law of the German federal states.

This directive specifies the requirements for installations in a building. It applies to electrical, sanitary and heating cable systems, but not to ventilation systems. The MLAR applies to installations in emergency routes, cable routing through separating walls and ceilings as well as to systems with electrical integrity in the event of a fire.

Thus, the protection aims according to the construction regulations are implemented in practice. There are similar regulations or directives in other European countries, which are dedicated to the topic of fire protection in buildings. In Austria, the cable systems directive dealing solely with the electrical installation is called ÖVE ÖNORM E 8002.

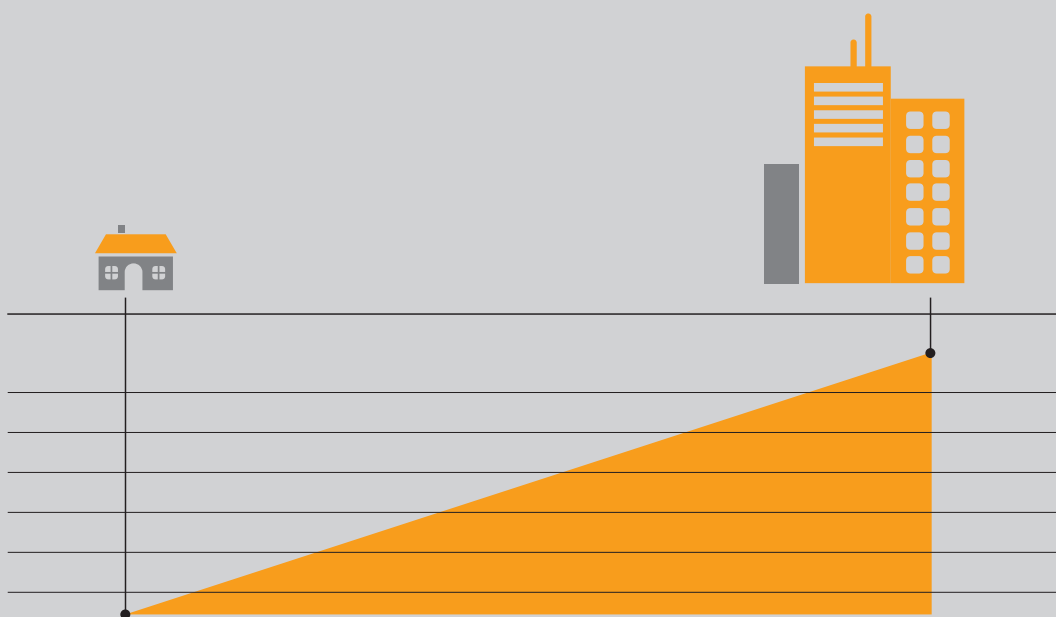

Schematic drawing of the increasing requirements for fire protection measures, depending on the building type and size

### 1.5.4.1 Construction law protection aims

Measures must be taken in buildings with a lot of people, so that, in the event of a fire, no one is injured by fire and smoke. The opportunity for a safe, quick exit must exist. During emergencies, it is people that are unfamiliar with the building who have great difficulty in correctly estimating the risks and leaving the building using the most direct route. Therefore, three steps are essential for the effective fire protection in a building:

#### First protection aim

Prevent formation and limit the spread of the fire.

#### Second protection aim

Protect escape and rescue routes

#### Third protection aim

Maintain the electrical function – important electrical systems must continue to operate

### Protection of property and the environment

The protection of property includes not only the protection of the building or the system, but also the protection of cultural goods and irreplaceable data. With regard to environmental protection, the German MBO prescribes this special protection aim: It states that "Public safety and order as well as life, health and the natural basics of life (may) not be endangered".

When implementing fire protection measures, environmental protection must also be observed. A system must be designed in such a way that, even in the event of a fire, neither people nor nature are endangered unnecessarily. In the industrial sector, it is also of course mandatory to implement the construction fire protection requirements. Also, in most cases, such systems require a fire protection concept, without which the system cannot be approved. This should also contain an appropriate lightning protection zone concept.

Besides the aspect of safety for those people working in the plant, the operator must also focus on the protection of their machines, products and warehouse facilities. These points are also of importance in terms of power generation. Protection of the usually very high investments in plant equipment is the main argument for a fire protection concept.

### 1.5.4.2 Building classes (using the example of Germany)

Not every building is subject to the high fire protection requirements. Therefore, in Germany, the MBO makes a distinction between various building classes, which each have different fire protection requirements. Classes 1 to 3 mostly contain smaller buildings, in which usually few people are to be found.

Higher buildings below the tower block limit of 22 metres are to be found in classes 4 & 5. In buildings regulated according to classes 1 to 5, a single structure rescue route is sufficient, e.g. a stairwell. In these buildings, rooms in upper storeys can be reached by the local fire brigade using portable ladders.

For higher buildings above 22 metres (upper edge of the floor of the top room), aerial rescue vehicles, e.g. rotary ladders, are required. Not every municipality possesses an appropriately equipped fire brigade, as these special vehicles are very expensive to buy. This is why these municipalities very infrequently have tower blocks.

Here, the formation of equipotential levels, together with an insulated lightning protection system, can represent an innovative and safe concept for protection against fire formation due to a direct lightning strike.



*Buildings exceeding the limits of the tower block limit or which are special structures should be protected with a lightning protection system of at least class 3.*

TBS Blitzschutz-Leitfaden 2018 / en / 2020/01/10 14:42:40 / 2020/01/10 14:42:40 (LLExploit\_02613) / 2020/01/10 14:42:54 14:42:54

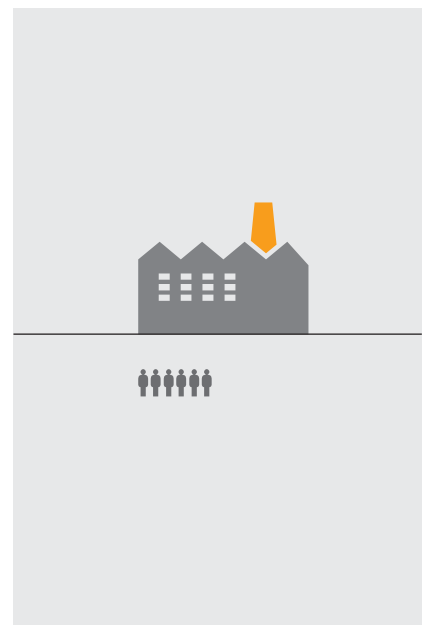

*Different objectives: Protecting people or property*

### 1.5.4.3 Special constructions

The requirements increase with larger construction projects. The requirements for special structures such as industrial buildings, tower blocks or meeting places are regulated by special specifications. It is possible that a building complex may be divided into various sections, the fire protection of which is viewed and evaluated in different ways according to the type of use. If there are no special regulations for a building, the minimum requirements of the state building regulations apply.

To be able to classify a special construction, at least one of the following "facts" must be fulfilled according to the Model Building Regulations:

- Exceeding a certain floor area
- Exceeding specified building heights
- High number of people usually located in the building
- Special use
- Processing and storage of hazardous substances

Examples could be the following special structures: tower blocks, shopping centres, schools, stadia, hospitals. Some of these special structures have special technical construction regulations and ordinances, e.g. meeting place ordinance, tower block directive, hospital construction ordinance and so on. These building types are termed "regulated" special structures. Alongside these are so-called "unregulated" special structures, for which there are no special regulations. However, here the general rules of technology apply, along with the minimum requirements of the state's laws.

### Classification of the building classes according to the Model Building Regulations (Germany)

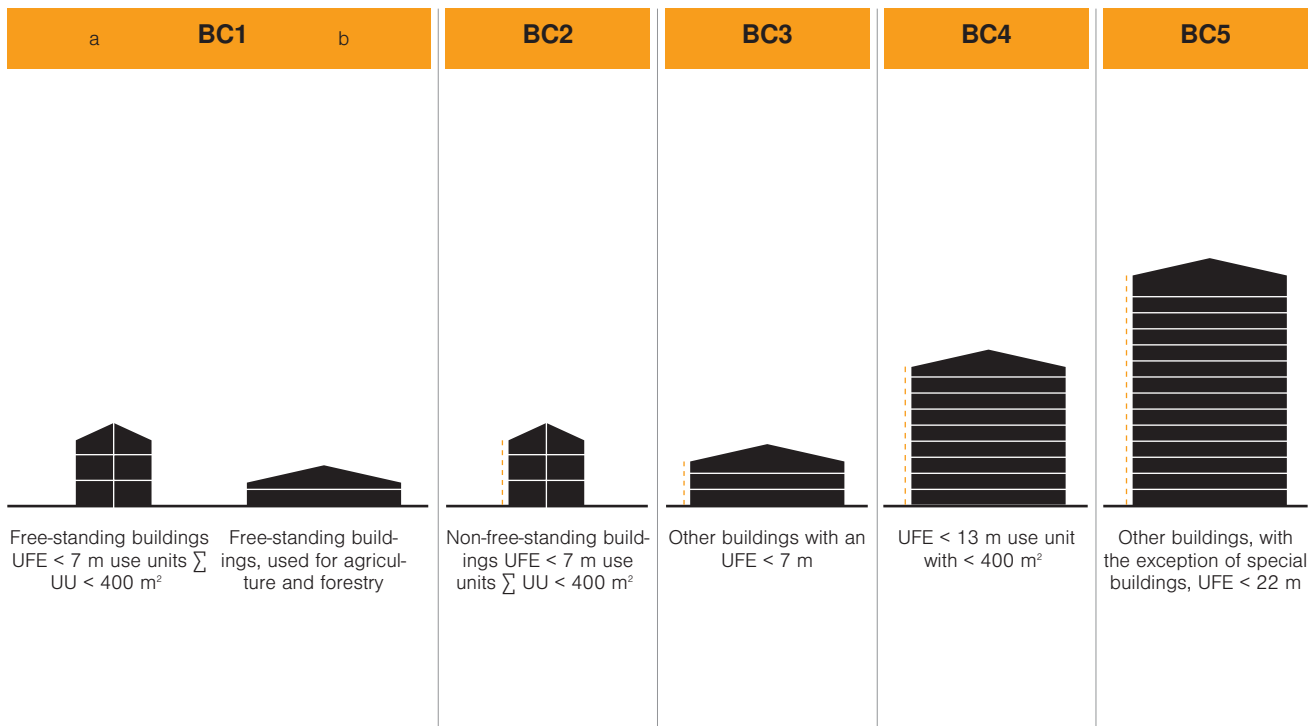

UFE: Upper floor edge of the highest storey

UU: Use units, BC: Building classes

#### 1.5.4.4 Four pillars of fire protection

General fire protection consists of four main pillars: in the field of general fire protection, the construction, systems and organisational fire protection as well as combative fire protection as the fourth pillar. This division means that the different areas and their aims can be defined more accurately.

#### Construction fire protection

There are different requirements, depending on the way a building is used. On the construction side, fire sections are formed, fire-resistant components defined or a lightning protection zone concept specified. The basis for this is the construction regula-

tions and special construction ordinances of the German states. These specify the minimum requirements for the building according to its use. Besides the construction law requirements for the stability and safety of a building or construction site, there are also additional requirements. Thus, it is surely in the interest of systems operators that the safety and availability of the building are at the forefront. This is also in the interests of the insurance companies: The more measures are implemented with regard to safe use, the lower the costs of the risk coverage conditions often are.



*The formation of fire sections through firewalls or components with fire resistance*



*Four pillars of fire protection*



TBS Blitzschutz-Leitfaden 2018 / en / 2020/01/17 14:42:40 (LLExport\_02613) / 2020/01/17 14:42:40 (LLExport\_02613) / 2020/01/17 14:42:40 (LLExport\_02613)



## 1.5.5 Protection class recommendation for preventive fire protection for structures

Building structure/ technical facility	Lightning protection MANDATORY (see 4.1.1): special structure with special structure regulation/directive (federal state-specific)	Lightning protection ADVISABLE (see 4.1.2): special structure (pursuant to § 2 Model Building Regulation/or equivalent in federal state building regulations)	Lightning protection class recommendation based on DIN EN 62305-2	Potential dangers, notes, additional requirements on usage types	Additional information, regulations, instruction sheets, guidelines
Alpine chalet		Special structure if: restaurant with more than 40 guest seats in the building or more than 1000 guest seats outside, accommodation with more than 12 beds and games hall measuring more than 150 m <sup>2</sup> .	III	- Danger of step and contact voltage - Difficulty in evacuating people - Damage to electrical equipment (such as electric lighting) that can trigger panic	ABB <sup>1</sup> Instruction Sheet: Refuge, VdS <sup>2</sup> 2082
Retirement home	SL <sup>3</sup> (HeimR) <sup>4</sup>  §§	Special structure if: building with usage units used for caring for or assisting people in need of care and disabled people who have limited ability to rescue themselves, if the usage units a) are each designed for more than 6 people, or b) are designed for people requiring intensive care, or c) have a shared rescue route and are designed for a total of more than 12 people.	III	- Danger of step and contact voltage - Difficulty in evacuating people - Risk of panic	VdS 2226
Archive		Special structure, because facility or rooms whose design and usage carry similar risks to defined special structures.	II	- Increased specific fire load - Potential data loss - Economic loss	
Observation tower/platform		Special structure, because facility or rooms whose design and usage carry similar risks to defined special structures.	III	- Danger of step and contact voltage - Difficulty in evacuating people - Risk of panic	ABB Instruction Sheet: Lightning protection for refuges, VdS 2171
Railway station with commercial usage units		Special structure, because facility or rooms whose design and usage carry similar risks to defined special structures.	II-III	- Primary risk of fire and dangerous step voltage as well as material damage - Secondary risk of power supply failure	Observe the regulations of Deutsche Bundesbahn and BO Strab <sup>5</sup>
Bank		Special structure if: building whose largest floor is greater than 1,600 m <sup>2</sup> , with the exception of residential buildings and garages.	III  Increased risk of fire: II	- Greater risk of fire because of storage contents - Damage to electrical equipment (such as electric lighting) that can trigger panic - Economic loss due to loss of production	
Swimming complexes (e.g. indoor swimming pool, combined complex and water entertainment complex)		Special structure, because recreation and pleasure park	Indoor swimming pool/open-air swimming pool: III Combined complex and water entertainment complex: II An expert (lightning protection expert) must make a site-specific assessment of every property.	- Widespread danger of step and contact voltage - Potential control essential	ABB Instruction Sheet: Lightning protection for swimming pools and bathing during thunderstorms, ABB Instruction Sheet: Football during thunderstorms, ABB Instruction Sheet: Lightning protection for audience facilities, ABB Instruction Sheet 18: Hazard area analysis
Place of accommodation		Special structure if: restaurant with more than 40 guest seats in the building or more than 1000 guest seats outside, accommodation with more than 12 beds and games hall measuring more than 150 m <sup>2</sup> .	III	- Danger of step and contact voltage - Difficulty in evacuating people - Damage to electrical equipment (such as electric lighting) that can trigger panic	VdS 2082

Table: Lightning protection class recommendation for preventive fire protection for structures (Source: Verband Deutscher Blitzschutzfirmen e.V., Guide no. 1, Legal and standardised principles for lightning protection on structures, 2018)

Building structure/ technical facility	Lightning protection MANDATORY (see 4.1.1): special structure with special structure regulation/directive (federal state-specific)	Lightning protection ADVISABLE (see 4.1.2): special structure (pursuant to § 2 Model Building Regulation/or equivalent in federal state building regulations)	Lightning protection class recommendation based on DIN EN 62305-2	Potential dangers, notes, additional requirements on usage types	Additional information, regulations, instruction sheets, guidelines
Sheltered workshop		Special structure, because day centre for more than 10 children or people with disabilities and old people.	III	- Danger of step and contact voltage - Difficulty in evacuating people - Greater risk of panic - Limited awareness	
Residential home for the disabled	SL (HeimR)  §§	Special structure, because building with usage units used for caring for or assisting people in need of care and disabled people who have limited ability to rescue themselves, if the usage units a) are each designed for more than 6 people, or b) are designed for people requiring intensive care, or c) have a shared rescue route and are designed for a total of more than 12 people.	III	- Danger of step and contact voltage - Difficulty in evacuating people - Risk of panic	VdS 2226
Sheltered housing	SL (HeimR)  §§	Special structure if: building with usage units used for caring for or assisting people in need of care and disabled people who have limited ability to rescue themselves, if the usage units a) are each designed for more than 6 people, or b) are designed for people requiring intensive care, or c) have a shared rescue route and are designed for a total of more than 12 people.	III	- Danger of step and contact voltage - Difficulty in evacuating people - Risk of panic	VdS 2226
Office and administrative building		Special structure if: building with rooms used for office administration and each larger than 400 m <sup>2</sup> .	III	- Risk of panic - Danger of step and contact voltage - Damage to electrical equipment (such as electric lighting) that can trigger panic	
Office building	BY <sup>6</sup> , BB <sup>7</sup> , HB <sup>8</sup> , HE <sup>9</sup> , MV <sup>10</sup> , NW <sup>11</sup> , SL, SH <sup>12</sup> > 22 m III (HHR) <sup>13</sup>  §§	Special structure if: building structures higher than 30 m.	> 30 m III > 100 m II	- Increased strike risk - Strikes to the side must be considered - Damage to electrical equipment (such as electric lighting) that can trigger panic	VdS 2019
Campsite and weekend area		Special structure, because camp site and weekend area	Expert to perform on-site assessment	- Danger of step and contact voltage - Danger of direct strikes to shelters	ABB Instruction Sheet: Lightning protection for tents, camping and on campsites
Heritage building (castle, ruin, archaeological site etc.)		Special structure, because facility or rooms whose design and usage carry similar risks to defined special structures	III	- Assets requiring protection - Loss of irreplaceable cultural assets	VdS 2171 VDI <sup>14</sup> 3817 Observe the regulations of the Office for the Preservation of Monuments
Maternity hospital	SL <sup>15</sup> (KhBauR)  §§	Special structure, because facility or rooms whose design and usage carry similar risks to defined special structures.	III		
Refugee hostel	Requirement in every federal state if: • Hall • Tent > 75 m <sup>2</sup> • Container • Air-dome  §§	Special structure, because miscellaneous facility for accommodating people, or residential home (e.g. standard building in exposed location).	III	- Danger of step and contact voltage - Difficulty in evacuating people - Risk of panic	DKE <sup>16</sup> Information Paper

Table: Lightning protection class recommendation for preventive fire protection for structures (Source: Verband Deutscher Blitzschutzfirmen e.V., Guide no. 1, Legal and standardised principles for lightning protection on structures, 2018)

Building structure/ technical facility	Lightning protection MANDATORY (see 4.1.1): special structure with special structure regulation/directive (federal state-specific)	Lightning protection ADVISABLE (see 4.1.2): special structure (pursuant to § 2 Model Building Regulation/or equivalent in federal state building regulations)	Lightning protection class recommendation based on DIN EN 62305-2	Potential dangers, notes, additional requirements on usage types	Additional information, regulations, instruction sheets, guidelines
Open-air swimming pool Recreation and pleasure park		Special structure, because recreation and pleasure park	Open-air swimming pool: <b>III</b> Recreation and pleasure park: <b>II</b>  An expert must make a site-specific assessment of every property.	- Potential control essential - Danger of step and contact voltage	ABB Instruction Sheet: Lightning protection for swimming pools and bathing during thunderstorms, ABB Instruction Sheet: Football during thunderstorms, ABB Instruction Sheet: Lightning protection for audience facilities, ABB Instruction Sheet 18: Hazard area analysis
Marquee		Special structure if: temporary structures that require model approval, and fairground rides that are not temporary structures and are subject to approval.	<b>III</b>	Danger of step and contact voltage	ABB Instruction Sheet: Lightning protection for audience facilities, ABB Instruction Sheet: Lightning protection for events and gatherings
Fire brigade (appliance room, control room)		Special structure, because facilities and rooms whose design and usage are associated with risks similar to defined special structures.	<b>II-III</b>	Public service, availability	
Forensic institution		Special structure, because penal facility and building structure for forensic commitment.	<b>III</b>	- Limited means of escape - Risk of panic	
Bed & breakfast, restaurant		Special structure if: restaurant with more than 40 guest seats in the building or more than 1000 guest seats outside, accommodation with more than 12 beds and games hall measuring more than 150 m <sup>2</sup> .	<b>III</b>	- Danger of step and contact voltage - Difficulty in evacuating people - Damage to electrical equip- ment (such as electric lighting) that can trigger panic	VdS 2082
Business estab- lishment (used for commercial purposes such as industry, trades, retail, department store)		Special structure, because facility or rooms whose design and usage carry similar risks to defined special structures.	<b>III</b>		VkV <sup>17</sup> , fire protection certificate ArbSchG <sup>18</sup> /risk assessment
Golf course		Special structure, because recreation and pleasure park	Refuge: <b>III</b>  An expert must make a site-specific assessment of every property.	- Potential control essential - Danger of step and contact voltage	ABB Instruction Sheet: Lightning protection for refuges
Bus stop			<b>III</b>	- Public transport facilities and associated facilities and operations, excluding buildings on airfields - Personal protection	ABB Instruction Sheet: Lightning protection for refuges BO Strab
High-rise building	BY, BB, HB, HE, MV, NW, SL, SH > 22 m <b>III</b> (HHR)  §§	Special structure if: building structures higher than 30 m.	HHR: > 22 m <b>III</b> > 100 m <b>II</b>  Otherwise: > 30 m <b>III</b> > 100 m <b>II</b>	- Increased strike risk - Strikes to the side must be considered - Damage to electrical equip- ment (such as electric lighting) that can trigger panic	VdS 2019
High rack warehouse		Special structure if: shelves on which stocks are piled are higher than 7.5 m at the top edge.	<b>II</b>	Exposed strike point	VDI 3564 VDI 3564 stipulates the construction of a lightning protection system, ArbSch- G/risk assessment

Table: Lightning protection class recommendation for preventive fire protection for structures (Source: Verband Deutscher Blitzschutzfirmen e.V., Guide no. 1, Legal and standardised principles for lightning protection on structures, 2018)

Building structure/ technical facility	Lightning protection MANDATORY (see 4.1.1): special structure with special structure regulation/directive (federal state-specific)	Lightning protection ADVISABLE (see 4.1.2): special structure (pursuant to § 2 Model Building Regulation/or equivalent in federal state building regulations)	Lightning protection class recommendation based on DIN EN 62305-2	Potential dangers, notes, additional requirements on usage types	Additional information, regulations, instruction sheets, guidelines
Hotel		Special structure if: restaurant with more than 40 guest seats in the building or more than 1000 guest seats outside, accommodation with more than 12 beds and games hall measuring more than 150 m <sup>2</sup> .	III	- Danger of step and contact voltage - Difficulty in evacuating people - Damage to electrical equipment (such as electric lighting) that can trigger panic	VdS 2082
Industrial/production facility		Special structure if: building whose largest floor is greater than 1,600 m <sup>2</sup> , with the exception of residential buildings and garages	III  Increased risk of fire (high specific fire load and threat to the environment): II	- The size of the building means there is a very large catchment area for direct/indirect lightning strikes - Greater risk of fire because of warehouse contents - Economic loss due to loss of production - Damage to electrical equipment (such as electric lighting) that can trigger panic	VDI 3564 ArbSchG/risk assessment
Boarding school		Special structure, because miscellaneous facility for accommodating people, or residential home.	III	- Danger of step and contact voltage - Difficulty in evacuating people - Risk of panic	
Penal facility and building structure for forensic commitment		Special structure, because penal facility and building structure for forensic commitment.	III	- Limited means of escape - Risk of panic	
Children's home	SL (KhBauR)  §§	Special structure if: people in need of care and disabled people who have limited ability to rescue themselves, if the usage units are larger than 6 people, people who need intensive care, shared rescue route for more than 12 people.	III	- Danger of step and contact voltage - Difficulty in evacuating people - Risk of panic	VdS 2226
Church, mosque		Special structure if: building with rooms which are each designed for use by more than 100 and max. 200 people.	III	- Danger of step and contact voltage - Damage to electrical equipment (such as electric lighting) that can trigger panic - Danger because of potential strike points (e.g. church with steeple, mosque with minaret)	ABB Instruction Sheet: Events
Day nursery		Special structure, because day centre for more than 10 children or people with disabilities and old people.	III	- Danger of step and contact voltage - Difficulty in evacuating people - Greater risk of panic - Limited awareness	
Sewage plant/pumping station			II-III	Public service, availability	ArbSchG/risk assessment
Monastery/convent		Special structure if: miscellaneous facility for accommodating people, or residential home.	III	- Danger of step and contact voltage - Difficulty in evacuating people - Risk of panic	
Power station, power station systems		Special structure, because heat-producing facility	III	Failure of public service	ABB Instruction Sheet: Lightning protection on chimneys, ArbSchG/risk assessment
Crematorium			III	Failure of public service	ABB Instruction Sheet: Lightning protection on chimneys

Table: Lightning protection class recommendation for preventive fire protection for structures (Source: Verband Deutscher Blitzschutzfirmen e.V., Guide no. 1, Legal and standardised principles for lightning protection on structures, 2018)



Building structure/ technical facility	Lightning protection MANDATORY (see 4.1.1): special structure with special structure regulation/directive (federal state-specific)	Lightning protection ADVISABLE (see 4.1.2): special structure (pursuant to § 2 Model Building Regulation/or equivalent in federal state building regulations)	Lightning protection class recommendation based on DIN EN 62305-2	Potential dangers, notes, additional requirements on usage types	Additional information, regulations, instruction sheets, guidelines
<b>Hospital</b>	BW <sup>19</sup> , BB, NW, SL (KhBauR) 	Hospital	Rooms used medically as described in DIN VDE 0100-710, usage group II, require a Class II LPS (e.g. operating theatres, ICUs) Ward, administrative building: <b>III</b> (see DIN VDE 0185-305-3 supplementary sheet 2)	- Difficulties in evacuating - Danger of step and contact voltage - Damage to electrical equip- ment (such as electric lighting) that can trigger panic - Risk of failure of life support systems	VdS 2226
<b>Cold storage facility</b>		Special structure, because facilities and rooms whose design and usage are associated with risks similar to defined special structures.	<b>III</b>	- Economic losses	
<b>Agriculture and forestry (building structure)</b>		Special structure, because facility or rooms whose design and usage carry similar risks to defined special structures. Sheds, homes, buildings > 10,000 m <sup>2</sup> .	<b>III</b>  Hay/straw store: <b>II</b>	- Primary risk of fire and dan- gerous step voltages as well as material damage - Secondary risk of power supply failure, danger to live- stock due to the failure of elec- tronic controllers for ventilation and feeding systems	VdS 2067
<b>Storage facility</b>		Special structure if: building whose largest floor is greater than 1,600 m <sup>2</sup> , with the exception of residential buildings and garages. 	<b>III</b>  Increased risk of fire (high specific fire load and threat to the environment): <b>II</b>	- The size of the building means there is a very large catchment area for direct/indirect lightning strikes - Greater risk of fire because of warehouse contents - Economic loss due to loss of production - Damage to electrical equip- ment (such as electric lighting) that can trigger panic - Data loss	VDI 3564 ArbSchG/risk assessment
<b>Warehouse</b>		Special structure if: shelves on which stocks are piled are higher than 7.5 m at the top edge.	<b>II</b> VDI 3564 stipulates the construction of a lightning protection system	- Exposed strike point	VDI 3564 ArbSchG/risk assessment
<b>Logistics centre</b>		Special structure if: building whose largest floor is greater than 1,600 m <sup>2</sup> , with the exception of residential buildings and garages.	<b>III</b>  Increased risk of fire (high specific fire load): <b>II</b>	- The size of the building means there is a very large catchment area for direct/indirect lightning strikes - Greater risk of fire because of warehouse contents - Economic loss due to loss of production - Damage to electrical equip- ment (such as electric lighting) that can trigger panic - Data loss	
<b>Refuse incinerator</b>		Special structure, because heat-producing facility	<b>III</b>	Failure of public service.	ABB Instruction Sheet Lightning protection on chimneys, ArbSchG/risk assessment
<b>Museum</b>		Special structure, because facilities and rooms whose design and usage are associated with risks similar to defined special structures.	<b>III</b>	- Storage of assets of irreplace- able value – economic factor - Publicly accessible building frequented by the general public	
<b>Control room</b>			<b>II</b>	- Economic loss due to loss of production - Loss of control in the event of system breakdown	

Table: Lightning protection class recommendation for preventive fire protection for structures (Source: Verband Deutscher Blitzschutzfirmen e.V., Guide no. 1, Legal and standardised principles for lightning protection on structures, 2018)



Building structure/ technical facility	Lightning protection MANDATORY (see 4.1.1): special structure with special structure regulation/directive (federal state-specific)	Lightning protection ADVISABLE (see 4.1.2): special structure (pursuant to § 2 Model Building Regulation/or equivalent in federal state building regulations)	Lightning protection class recommendation based on DIN EN 62305-2	Potential dangers, notes, additional requirements on usage types	Additional information, regulations, instruction sheets, guidelines
Open-air event		Special structure if: temporary structures that require model approval, and fairground rides that are not temporary structures and are subject to approval.	III (II) Recommendation: Expert to assess the site.	- Danger of step and contact voltage - Danger of direct strikes to extensive audience areas	ABB Instruction Sheet: Lightning protection for audience facilities, ABB Instruction Sheet: Lightning protection for events and gatherings
Parking structure		Special structure, because garage/parking structure	III	- Risk of direct lightning strikes to the top parking deck, and risk of step and contact voltage	
Guest house		Special structure if: restaurant with more than 40 guest seats in the building or more than 1000 guest seats outside, accommodation with more than 12 beds and games hall measuring more than 150 m <sup>2</sup> .	III	- Danger of step and contact voltage - Difficulty in evacuating people - Damage to electrical equipment (such as electric lighting) that can trigger panic	VdS 2082
Nursing home	SL (HeimR) 	Special structure if: building with usage units used for caring for or assisting people in need of care and disabled people who have limited ability to rescue themselves, if the usage units a) are each designed for more than 6 people, or b) are designed for people requiring intensive care, or c) have a shared rescue route and are designed for a total of more than 12 people.	III	- Danger of step and contact voltage - Difficulty in evacuating people - Risk of panic	VdS 2226
Police		Special structure, because facility or rooms whose design and usage carry similar risks to defined special structures.	III	Public service, availability	
Photovoltaic system			Depending on place of installation, compliant with DIN EN 62305-3 supplementary sheet 5 (e.g. open-air installation): III		ABB Instruction Sheet No. 11: Lightning protection for photovoltaic systems
Data centre			I	- Internal system failure caused by LEMP - Lightning protection concept pursuant to DIN EN 62304-4 - Assess need for shielding	
Hall (event venue)		Special structure if: building with rooms which are each designed for use by more than 100 and max. 200 people.	III	- Danger of step and contact voltage - Danger because of potential strike points - Damage to electrical equipment (such as electric lighting) that can trigger panic	
Shipping buildings and facilities (e.g. lock)			III	- Public service	
School, university and similar facility	BB, HE, MV, NI <sup>20</sup> , NW, RP <sup>21</sup> , SL, SN <sup>22</sup> , ST <sup>23</sup> , SH, TH <sup>24</sup> (SchulbauR) <sup>25</sup> 	Special structure, because school, university or similar facility	III	- Danger of step and contact voltage - Damage to electrical equipment (such as electric lighting) that can trigger panic	

Table: Lightning protection class recommendation for preventive fire protection for structures (Source: Verband Deutscher Blitzschutzfirmen e.V., Guide no. 1, Legal and standardised principles for lightning protection on structures, 2018)



Building structure/ technical facility	Lightning protection MANDATORY (see 4.1.1): special structure with special structure regulation/directive (federal state-specific)	Lightning protection ADVISABLE (see 4.1.2): special structure (pursuant to § 2 Model Building Regulation/or equivalent in federal state building regulations)	Lightning protection class recommendation based on DIN EN 62305-2	Potential dangers, notes, additional requirements on usage types	Additional information, regulations, instruction sheets, guidelines
Training facility		Special structure if: building with rooms which are each designed for use by more than 100 and max. 200 people.	III	- Danger of step and contact voltage - Danger because of potential strike points - Damage to electrical equipment (such as electric lighting) that can trigger panic	VStättV <sup>26</sup>
Refuge		Special structure if: restaurant with more than 40 guest seats in the building or more than 1000 guest seats outside, accommodation with more than 12 beds and games hall measuring more than 150 m <sup>2</sup> .	III	- Danger of step and contact voltage - Difficulty in evacuating people - Damage to electrical equipment (such as electric lighting) that can trigger panic	ABB Instruction Sheet: Refuge, VdS 2082
Nurses' accommodation		Special structure, because miscellaneous facility for accommodating people, or residential home.	III	- Danger of step and contact voltage - Difficulty in evacuating people - Risk of panic	
Cable car		Special structure if: system subject to mining authorities.	III	Personal protection	
Day-care facility	SL (HeimR) 	Special structure if: day centre for more than 10 children or people with disabilities and old people	III	- Danger of step and contact voltage - Difficulty in evacuating people - Greater risk of panic - Limited awareness	
Student residence		Special structure if: miscellaneous facility for accommodating people, or residential home.	III	- Danger of step and contact voltage - Difficulty in evacuating people - Risk of panic	
Dead animal removal facility		Special structure if: heat-producing facility	III	Failure of public service.	ABB Instruction Sheet: Lightning protection on chimneys, ArbSchG/risk assessment
Stadium stands		Special structure if: temporary structures that require model approval, and fairground rides that are not temporary structures and are subject to approval.	III covered, II not covered  Recommendation: Expert to assess the site.	- Danger of step and contact voltage	ABB Instruction Sheet: Lightning protection for audience facilities, ABB Instruction Sheet: Lightning protection for events and gatherings
Tower, chimney (free-standing)		Special structure if: heat-producing facility	II		ABB Instruction Sheet: Lightning protection on chimneys
Subterranean building (building structure for mining, underground car park, bunker etc.)		Special structure, because facilities and rooms whose design and usage are associated with risks	III		
Shop	2,000 m <sup>2</sup> and more: BW, BY, BB, HH, HE, MV, NI, NW, RP, SL, SN, SH, TH (VKV) 	Special structure if: retail spaces and shopping streets that have a total area of more than 800 m <sup>2</sup> .	III	- Danger of step and contact voltage - Damage to electrical equipment (such as electric lighting) that can trigger panic	

Table: Lightning protection class recommendation for preventive fire protection for structures (Source: Verband Deutscher Blitzschutzfirmen e.V., Guide no. 1, Legal and standardised principles for lightning protection on structures, 2018)

Building structure/ technical facility	Lightning protection MANDATORY (see 4.1.1): special structure with special structure regulation/directive (federal state-specific)	Lightning protection ADVISABLE (see 4.1.2): special structure (pursuant to § 2 Model Building Regulation/or equivalent in federal state building regulations)	Lightning protection class recommendation based on DIN EN 62305-2	Potential dangers, notes, additional requirements on usage types	Additional information, regulations, instruction sheets, guidelines
	BW, BY, BB, HH, MV, NI, NW, SL, SN, ST, SH (VStättV)  §§		III		
Waterworks			III	Public service, availability	
Windmill			III		
Residential building		Special structure if: building structures higher than 30 m.	> 30 m III > 100 m II	- Increased strike risk - Strikes to the side must be considered - Damage to electrical equipment (such as electric lighting) that can trigger panic	VdS 2019
Residential building with combustible roof (e.g. thatch)			III	- Breakdown of electrical systems - Fire as well as material damage - Failure of electrical and electronic equipment (e.g. modem, computer, telephone)	ABB Instruction Sheet No. 14: Lightning protection for thatched roofs
Residential building, heritage protected		Special structure if: heritage building	Reduced risk analysis required		
Residential building, category 1: Freestanding building without special design or usage Building with a height of up to 7 m and up to two usage units, no bigger than 400 m <sup>2</sup>			Reduced risk analysis required		
Residential building, category 2-4: General building, not in an exposed position and without special design or usage Building with a height of up to 13 m and usage-units no bigger than 400 m <sup>2</sup>			Reduced risk analysis required		

Table: Lightning protection class recommendation for preventive fire protection for structures (Source: Verband Deutscher Blitzschutzfirmen e.V., Guide no. 1, Legal and standardised principles for lightning protection on structures, 2018)

A calculation of the lightning protection class according to IEC/EN 62305-2 can lead to higher classes, depending on the project. Also, legal or operator-specific requirements may prescribe high lightning protection classes. In these cases, the higher class must be selected.

<sup>1</sup> Lightning Protection and Research Committee (VDE), <sup>2</sup> German loss prevention council, <sup>3</sup> Saarland, <sup>4</sup> HeimR: Directive for guidelines on building inspectorate requirements for retirement homes, residential homes for the aged and care homes (including temporary care) and residential homes for the disabled, <sup>5</sup> Ordinance on the Construction and Operation of Trams, <sup>6</sup> Bayern, <sup>7</sup> Brandenburg, <sup>8</sup> Bremen, <sup>9</sup> Hessen, <sup>10</sup> Mecklenburg-Vorpommern, <sup>11</sup> Nordrhein-Westfalen, <sup>12</sup> Schleswig-Holstein, <sup>13</sup> Regulations on high-rise buildings, <sup>14</sup> Association of German Engineers, <sup>15</sup> Krankenhausbaurichtlinie: Regulations on building hospitals, <sup>16</sup> German Commission for Electrical, Electronic and Information Technologies, <sup>17</sup> Regulations on retail spaces, <sup>18</sup> German Occupational Safety and Health Act, <sup>19</sup> Baden-Württemberg, <sup>20</sup> Lower Saxony, <sup>21</sup> Rhineland-Palatinate, <sup>22</sup> Saxony, <sup>23</sup> Saxony-Anhalt, <sup>24</sup> Thuringia, <sup>25</sup> Regulations on the building of schools, <sup>26</sup> Regulations governing venues, <sup>27</sup> Hamburg



### 1.5.6 Responsibility of the erection engineer

"The commissioner has the overall responsibility for the electrical safety." The erection of a lightning protection system often requires major intervention in the electrical infrastructure of a building. This is reflected in the wide range of standards and regulations to be complied with. The erection engineer of the system is liable for correct fulfilment for 30 years, and the requirements of the insurance company come on top of that.

The specialist company installing an electrical system is required by law to hand it over in perfect condition. According to the low-voltage connection ordinance (connection ordinance in Germany), the electrician listed in the energy supplier's installer list may only connect tested and correct systems to the public power grid.

Please observe the appropriate local and statutory requirements. Depending on the system type, the following standards must be complied with:

- Low-voltage electrical installations
  - IEC 60364-4-41
  - IEC 60364-4-44
  - IEC 60364-4-534
- Tests (commissioning test) and documentation
  - IEC 60364-6
  - EN 50110-1
- Requirements for solar PV power supply systems
  - IEC 60634-7-712
  - IEC 62446

### 1.5.7 Responsibility of the operator

For the plant operator, there is the obligation to make a contribution to maintenance through regular recurring checks. The checking and maintenance of the electrical system components may only be carried out by an electrical technician.

*"People, animals and property must be protected against damage from surge voltages, the consequences of atmospheric impacts or switching surges."*

IEC 60364-1





Building damage due to a direct lightning strike

**Further costs can also be incurred due to outages and consequential damage in relation to**

- Loss of data
- Production outage
- Loss of contactability (Internet, telephone, fax)
- Defective heating systems
- Costs due to faults and false alarms in fire and burglar alarm systems

**Financial losses are on the rise**

Current statistics and estimates of insurance companies show: Damage levels caused by surges – excluding consequential or outage costs – long since reached drastic levels due to the growing dependency on electronic "aids". It's no surprise, then, that property insurers are checking more and more claims and stipulating the use of devices to protect against surges. Information on protection measures can be found in, for example, the German Directive VdS 2010.

**1.6 Financial implications of lightning and surge voltage damage**

Financial losses can only be considered in isolation in cases where no legal or insurance requirements relating to personal safety apply.

**Substantial losses result from the destruction of electrical devices, notably:**

- Computers and servers
- Telephone systems
- Fire alarm systems
- Monitoring systems
- Lift, garage door and roller shutter drives
- Consumer electronics
- Kitchen appliances

Year	Number of lightning and surge voltage damage cases	Paid damages for lightning and surge voltage damage
1999	490,000	€310 million
2006	550,000	€340 million
2007	520,000	€330 million
2008	480,000	€350 million
2009	490,000	€340 million
2010	330,000	€220 million
2011	440,000	€330 million
2012	410,000	€330 million
2013	340,000	€240 million
2014	410,000	€340 million
2015	350,000	€240 million
2016	320,000	€250 million
2017(1)	300,000	€250 million

Table 1.3: Number of instances of damage from lightning and surge voltages and amounts paid out by home and contents insurance companies; source: www.GDV.de , (1) preliminary, date June 2018

## 1.7 Lightning protection risk analysis and categorisation by lightning protection class

The risk of lightning strikes can be determined by carrying out a risk analysis according to IEC 62305-2. The local risk is determined by multiplying the frequency of lightning strikes with the likelihood of damage and a factor to cover the likely loss/extent of damage.

The building's required risk level is determined on the basis of the risk of lightning strike and the damage that can be expected. This corresponds to the required lightning protection class (Table 1.4). In Germany, the standard DIN EN 62305-2 includes three national supplements containing additional information on risk management – for example, Supplement 2 (Calculation aids for estimating the risk of damage for structures), which offers assistance with the often complicated process of assessing the risk of damage.

Alternatively, the lightning protection class can be determined on the basis of statistical data, e.g. claim statistics from property insurance companies. Efficiency in lightning protection class I is the highest at 98%, and in lightning protection class IV the lowest at 79%.

The cost and time involved in erecting a lightning protection system (e.g. necessary protective angle and spacings of grids and arresters) is more involved for lightning protection class I systems than for lightning protection class IV systems.

Risk level (LPL = lightning protection level)	Lightning protection class (LPS = class of lightning protection system)
I	I
II	II
III	III
IV	IV

Table 1.4: LPL vs. LPS

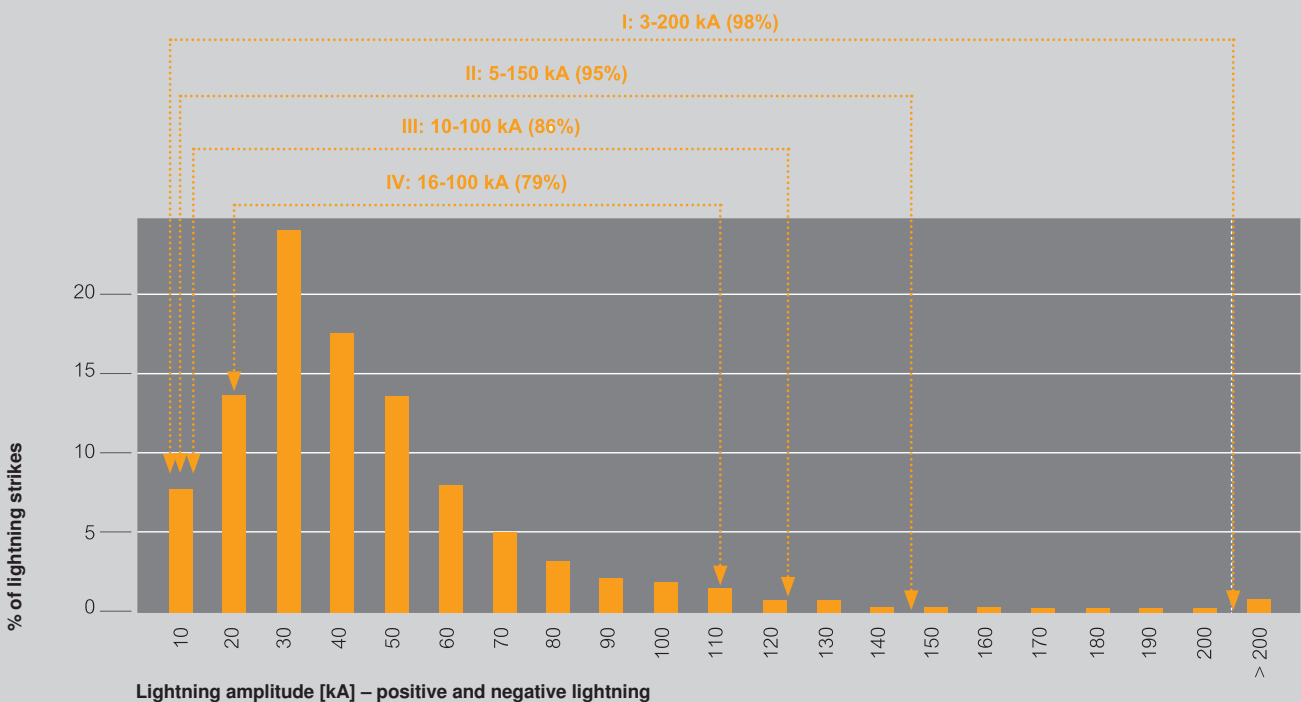

Lightning current parameters according to the risk level (LPL) in accordance with DIN VDE 0185-305-1

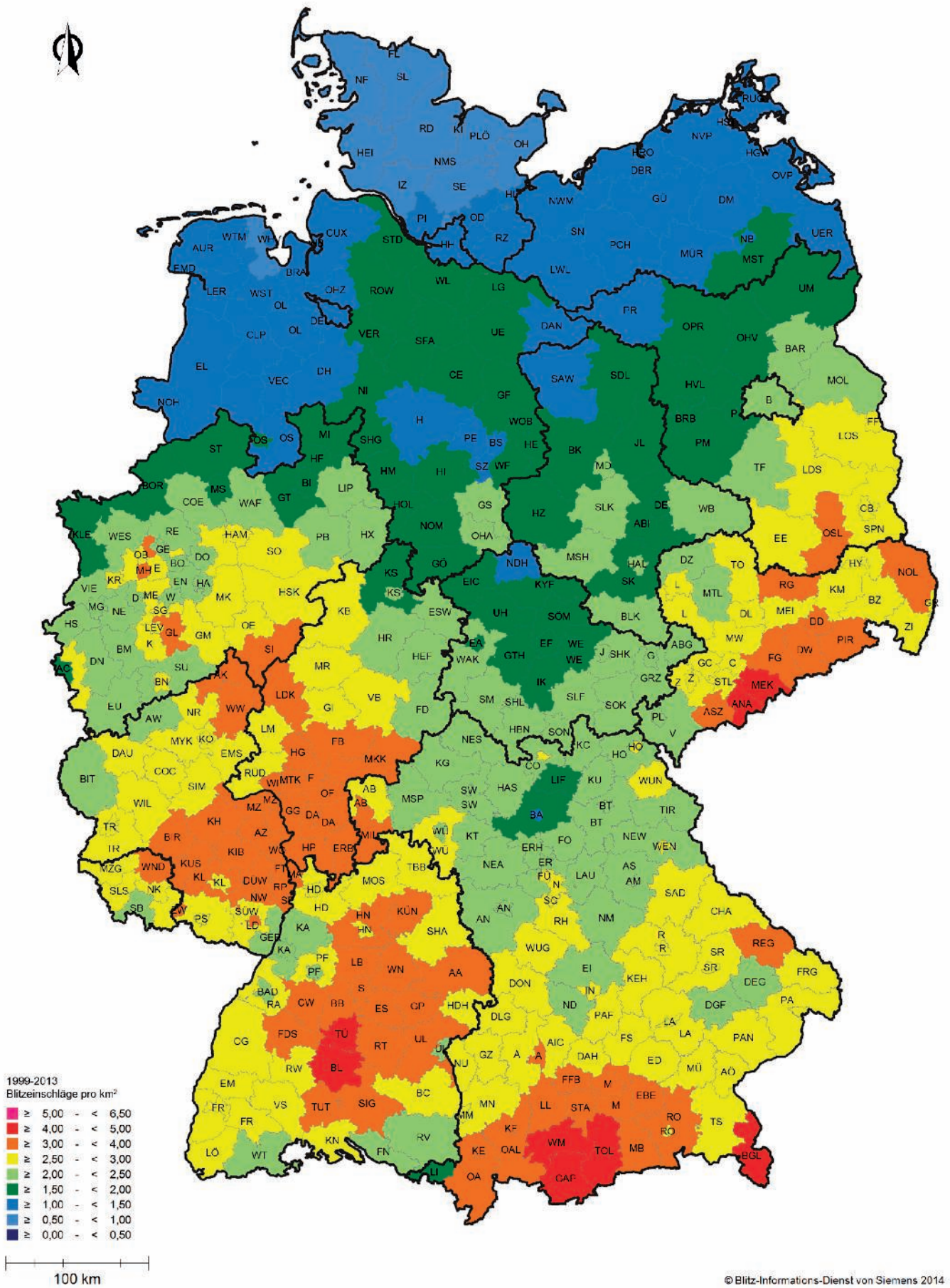

Frequency of lightning strikes per km<sup>2</sup> in Germany. Source: www.siemens.com

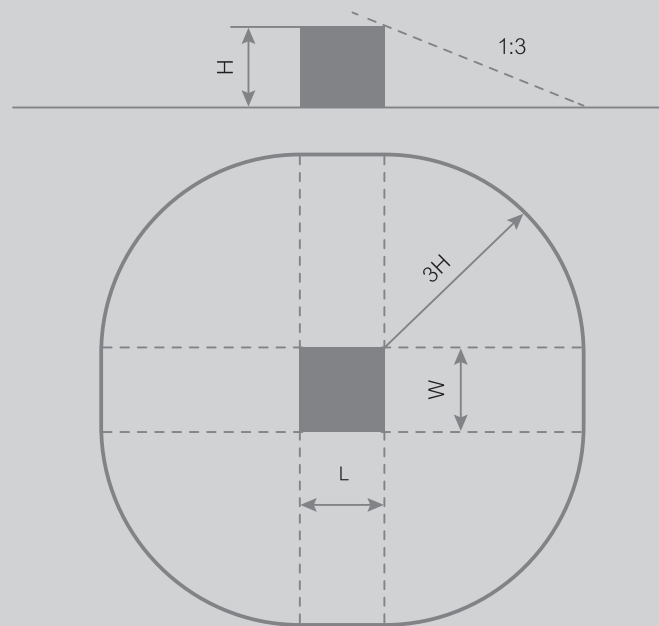

<b>H</b>	Height of the building structure
<b>W</b>	Width of the building structure
<b>L</b>	Length of the building structure

Equivalent interception area for direct lightning strikes

### The effectiveness of a lightning protection system is indicated by assigning it a lightning protection class between I and IV:

- Lightning protection class I = greatest need for protection, e.g. hospitals
- Lightning protection class II = substantial need for protection, potential explosive areas
- Lightning protection class III = limited need for protection, housing
- Lightning protection class IV = smallest need for protection (not normally used in Germany)

#### 1.7.1 Frequency of lightning strikes by region

A large number of countries maintain statistics on the frequency of lightning strikes in that country. Thanks to the BLIDS lightning location system, region-specific data is available for Germany, Austria and Switzerland. Further data can be found in national supplement 1 to the German standard DIN EN 62305-2. The standard recommends doubling these values.

#### 1.7.2 Equivalent interception area

The risk analysis considers not just the real area of the building but also the equivalent interception area as areas at risk from lightning. Direct and nearby lightning strikes lead to the coupling of electric current into building structures. The equivalent interception area is a circle with a radius three times the building's height, centred on the building's base. Damage can also be caused by lightning striking supply lines leading into the building, or lightning striking close to these lines.

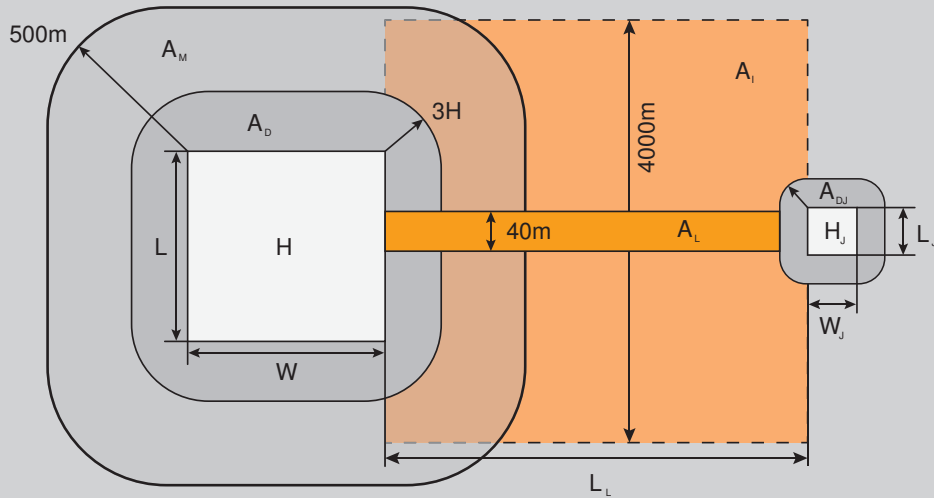

<b>L</b>	Length of the building structure
<b>W</b>	Width of the building structure
<b>H</b>	Height of the building structure
<b>A<sub>D</sub></b>	Equivalent interception area of the building structure
<b>A<sub>M</sub></b>	Equivalent interception area of couplings due to electromagnetic effect (building)
<b>A<sub>L</sub></b>	Equivalent interception area of supply lines
<b>A<sub>I</sub></b>	Equivalent interception area of couplings due to electromagnetic effect (line)

Equivalent interception area for indirect lightning strikes

The equivalent interception area for indirect lightning strikes is a circle with a radius of 500 m around the base of the building and an area extending 2,000 m either side of the supply line.

### 1.7.3 Estimation of the damage risk

The damage risk is assessed using the lightning threat data and the possible damage. The greater the risk of a lightning strike and the likely damage, the more effective must be the design of the lightning protection system.

#### Lightning threat data:

- Frequency of lightning strikes by region
- Equivalent interception area

#### Possible damage:

- Injury to or death of people
- Unacceptable failure of services
- Loss of irreplaceable cultural treasures
- Financial loss

Application	Lightning protection class according to IEC 62305
Computer centres, military applications, nuclear power stations	I
Ex zones in industry and the chemicals sector	II
Photovoltaic systems > 10 kW	III
Museums, schools, hotels with more than 60 beds	III
Hospitals, churches, storage facilities, meeting places accommodating more than 100/200 people	III
Administrative buildings, sales points, offices and bank buildings of over 2,000 m <sup>2</sup>	III
Residential buildings with more than 20 apartments, multi-storey buildings over 22 m high	III
Photovoltaics (< 10 kW)	III

Table 1.5: Excerpt from Directive VdS 2010: Recommendation of property insurers for lightning protection classes

### 1.7.4 Empirical lightning protection classification of buildings

One way of determining the necessary lightning protection classes is through the use of statistical data. In Germany, the German Insurance Federation publishes Directive VdS 2010 (risk-oriented lightning and surge protection) which offers help in classifying buildings in this way. (Table 1.5)

With its Guide No. 1 "Legal and standardised principles for lightning protection on structures", VDB (Verband Deutscher Blitzschutzfirmen) e.V. supports the decision as to whether and how a lightning protection system is to be erected in Germany.

Lightning protection measures are always required when:

- A responsible authority demands them. In this case, the required lightning protection class should either be specified by the authority or determined through calculation.
- Lightning protection measures are required according to statutory requirements.
- The damage of a structure due to a lightning strike can also influence surrounding structures or the environment (e.g. spread of fire, explosion, chemical or radioactive emissions).

### 1.7.5 Cost-effectiveness calculation for lightning protection systems

In buildings where no danger is posed to humans, the need for lightning protection measures can be assessed according to purely economic criteria. On the one hand, it is necessary to consider the likelihood of a lightning strike and the cost of the damage that this would cause. On the other hand, this needs to be compared with the cost of a lightning protection system, and the reduction in damage that would be achieved by installing it.

#### 1.7.5.1 Costs without lightning protection system

In a building where no lightning protection measures have been taken, the annual costs are determined by multiplying the probability of a lightning strike in the building with the damage that a lightning strike is likely to do to the property.

#### 1.7.5.2 Costs with lightning protection system

In a building where lightning protection measures have been taken, the likelihood of damage (lightning strike in the building) occurring is smaller. The annual costs are determined by multiplying the (now lower) probability of a lightning strike with the likely damage that a lightning strike would cause at the property, and the annual costs of the lightning protection system.

#### 1.7.5.3 Comparing the costs of lightning damage in buildings with and without a lightning protection system

The cost-effectiveness of lightning protection measures is assessed by comparing the annual costs for an unprotected building with the annual costs for a protected building.

#### Note

A precise calculation involving numerous other parameters must be carried out in the form of a risk analysis in accordance with IEC 62305-2.

**Cost-effectiveness without lightning protection system**

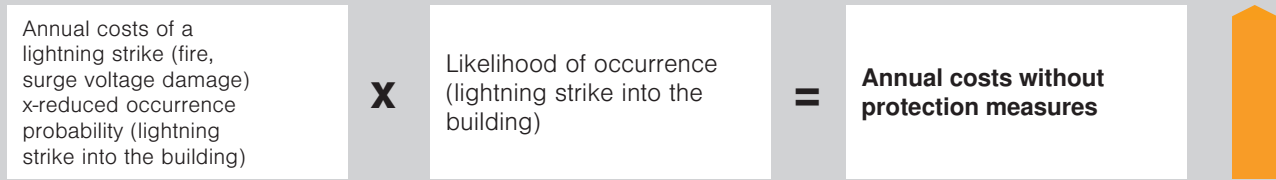

**Cost-effectiveness with lightning protection system**

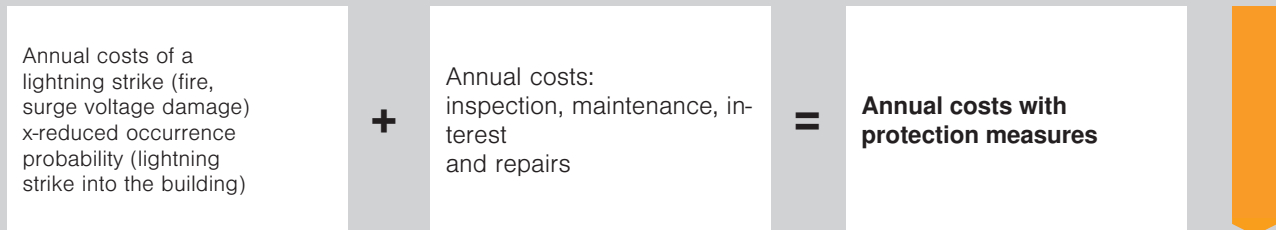

Cost comparison

*Risk management*

**Example (lightning damage in building without lightning protection system)**

- Value of building with contents: €500,000
- Lightning strikes per year: ≤ 1.6 per km<sup>2</sup>
- Building size: 10 m long, 20 m wide, 10 m high
- Interception area: 4,827 m<sup>2</sup>

**Likelihood of a lightning strike**

- $3.2 / 1,000,000 \text{ m}^2 \times 4,827 \text{ m}^2 = 0.015$  (= every 65 years)/theoretical value

**Annual costs in an unprotected building**

- €500,000 x 0.015 (total loss) = €7,500 per year

**Example (lightning damage in building with lightning protection system)**

- Value of building with contents: €500,000
- Lightning strikes per year: ≤ 1.6 per km<sup>2</sup> (doubled: ≤ 3.2 per km<sup>2</sup>)
- Building size: 10 m long, 20 m wide, 10 m high
- Interception area: 4,827 m<sup>2</sup>

**Likelihood of a lightning strike**

- Lightning protection class 3 = 86% protective impact = Residual risk 14% (0.14)
- Probability of risk occurrence:  $3.2 \times 14\% / 1,000,000 \text{ m}^2 \times 4,827 \text{ m}^2 = 0.0022$  (= every 462 years)

**Annual damage in protected building (not including costs of lightning protection system)**

- €500,000 x 0.0022 = €1,000 per year

**Calculation of costs for the lightning protection system**

- Costs of lightning protection system: €10,000
- Costs/depreciable life (20 years): €500 per year
- Annual interest incurred due to investment (5%): €500
- Annual maintenance costs for the lightning protection system (5%): €500
- Total annual cost of lightning protection system: €1,500

**Annual costs with protective measures (including costs of lightning protection system)**

- Annual damage: €1,100 per year
- Total annual cost of lightning protection system: €1,500
- Total costs: €2,600 per year

**Example**

Through suitable lightning protection measures, annual costs can be reduced by €4,900.





BET test generator

BET SO<sub>2</sub> testing system

## 1.8 Laboratory testing of lightning and surge protection components

In the BET Test Centre, lightning and surge protection components, lightning protection structures and surge protection devices are put through their paces by highly qualified specialists in accordance with the relevant standards. In addition, the impact of events involving lightning is scientifically investigated.

The BET possesses a test generator for lightning current tests of up to 200 kA and a hybrid generator for surge current tests of up to 20 kV.

Tasks performed include developmental tests of new developments and modifications to OBO surge protection devices according to the testing standard IEC 61643-11. The tests for lightning protection components are carried out according to IEC/EN 62561-1 and those for spark gaps according to IEC 62561-3.

The hybrid generator is used for testing data cable protection devices in accordance with IEC 61643-21 "Surge protective devices connected to telecommunications and signalling networks".

### The following standard-compliant tests can be carried out:

- Lightning protection components to EN 62561-1
- Spark gaps to EN 62561-3
- Holder to EN 62561-4
- Insulated components to IEC TS 62561-8
- Lightning current meters to EN 62561-6
- Surge protection devices to EN 61643-11
- Data cable protection devices to EN 61643-21
- Environmental testing to EN ISO 9227 (neutral continuous salt spray testing)
- Environmental testing to EN 60068-2-52 (cyclical salt spray testing)
- Environmental testing to EN ISO 6988 (SO<sub>2</sub> toxic gas testing)
- IP protection rating to EN 60592
- Tensile strength to EN 10002-1

However, customer-specific requirements and tests not covered by standards can be tested up to the following parameters:

- Lightning current pulses (10/350) up to 200 kA, 100 As and 10 MA<sup>2</sup>s
- Surge current pulses (8/20) up to 200 kA
- Combined surges (1.2/50) up to 20 kV
- Combined surges (10/700) up to 10 kV
- Follow current system 255 V, 50 Hz, up to 3 kA
- Insulation measurement up to 5 kV AC, 50 Hz and up to 6 kV DC
- Conductivity measurements up to 63 A, 50 Hz
- Tensile and compression strengths up to 100 kN

### 1.8.1 Standard-compliant testing

Top of the agenda at the BET Test Centre is the expert testing of OBO's surge voltage and lightning protection systems.

This includes testing newly developed products, modifying existing products and comparing lightning protection components, surge protection equipment and lightning current arresters.

**BET  
TESTED**

When planning and executing a lightning protection system, it is necessary to observe all relevant national standards, appendices and the safety stipulations in the relevant country-specific supplements. Non-application of the necessary care in the selection of the products used according to the current state of the art must be avoided.

OBO, as a leading manufacturer and complete provider in the field of lightning and surge protection, supports planners, installation engineers and LPS inspectors.



Test reports, certificates, declarations of conformity and mounting instructions are available for downloading directly by the appropriate product at [www.obo-bettermann.com](http://www.obo-bettermann.com).

#### Verbinder Rd 8-10 mm mit Druckwanne

- mit 1 Fix-Kontakt-Klemmschraube, Mutter und Federscheibe
- inkl. vormontierter Druckwanne
- entspricht den Anforderungen nach VDE 6185-305 (IEC 62305)



Download



Typ	Passung mm	Blitzstromtragfähigkeit kA	Verp. Stück	Gewicht kg/100 St.	Preis €/100 St.	Art.-Nr.	Markzettel
2001 N-VA	Rd 8-10	NISO	10	6,800	733,65	5304178	+

VZA | Edelstahl, rostfrei 1.4301

### 1.8.2 Certification

In development, manufacture and marketing, the products of OBO Bettermann are subject to high, standardised quality standards and international standards. For decades now, OBO Bettermann has operated ISO 9001-certified quality management, which also fulfils the high requirements of the ATEX 2014/34/EU directive for Ex products. In addition, OBO has run certified energy management according to ISO 50001 and is a long-standing member of Industrieverband Feuerverzinken e.V.

The BET Test Centre is a testing laboratory, recognised and certified by VDE, for the execution of countless tests according to international standards for lightning protection systems.



**Zertifikat zur Anerkennung**  
*Certificate of acceptance*

von / of  
OBO Bettermann GmbH & Co. KG  
BET Testcenter  
Hüingsser Ring 52  
58710 Menden  
GERMANY

durch die / by the  
**VDE Prüf- und Zertifizierungsinstitut GmbH**  
*VDE Testing and Certification Institute*

**Zertifikat**  
Mitteilung über die Bewertung des Qualitätssicherungssystems

1. Geräte und Schutzsysteme zur bestimmungsgemäßen Verwendung in explosionsgefährdeten Bereichen  
Richtlinie 2014/34/EU  
Anhang IV - Modul D: Konformität mit dem Baumuster auf der Grundlage einer Qualitätssicherung bezogen auf den Produktionsprozess  
Anhang VII - Modul E: Konformität mit dem Baumuster auf der Grundlage der Qualitätssicherung bezogen auf das Produkt

2. Nummer des Zertifikates: **BVS 16 ATEX ZQS/E310**

3. Produktkategorie: **Geräte und Komponenten**  
Gerätegruppe II, Kategorien 1G, 2G: Transienten- und Blitzschutz-Systeme

4. für das / for the **Acceptance Program**  
Stufe 2 / in Stage 2

40046136  
2019-08-22  
5022808-9501-0001/237781

in mit dem gültigen Dokument „TDAP SCOPE“. Es berechtigt den Inhaber des geschützten Zeichens des VDE, das in diesem Dokument „TDAP SCOPE“. Es does not refer to other VDE marks.

**Institut GmbH**  
Products

**VDE**  
INSTITUT

---

Industrieverband Feuerverzinken e.V. | Postfach 140461 | 40074 Düsseldorf

**Confirmation**

Herewith we confirm, that

**OBO BETTERMANN GmbH & Co. KG**  
Hüingsser Ring 52  
58710 Menden

is a member of our association

**Industrieverband Feuerverzinken e. V., Düsseldorf.**

The company OBO BETTERMANN GmbH & Co. KG provides among other things corrosion protection for fabricated iron and steel articles by hot dip galvanizing and examines that business in accordance with the requirements of the standard

**DIN EN ISO 1461**  
"Hot dip galvanized coatings on fabricated iron and steel articles – specifications and test methods".

Industrieverband Feuerverzinken e.V. | Düsseldorf, February 3rd, 2017  
- Director -

Industrieverband Feuerverzinken e.V.  
Postfach 140461 | 40074 Düsseldorf  
*Mark Huckhold*  
Mark Huckhold

Mitglied der European General Galvanizers Association EGGA - IRC DEU/DE/DB/BE - IBAN DE42 3007 0024 0589 1643 00

**WERT BEWAHREN FEUERVERZINKEN**

**OBO BETTERMANN**

Industrieverband Feuerverzinken e.V.  
Hörnsicher Weg 200  
40470 Düsseldorf  
Tel: 0211 490765-0  
Fax: 0211 490765-28  
info@feuerverzinken.com  
www feuerverzinken.com

OBO Bettermann GmbH & Co. KG  
Hüingsser Ring 52, 58710 Menden  
OBO Bettermann Hungary Kft., Alsóvárosi 2, 2347 Bogyi, Ungarn

DEKRA EXAM GmbH, benannte Stelle Nr. 0158 gemäß Artikel 17 der 4034/EU vom 26. Februar 2014, bescheinigt, dass der Hersteller ein Qualitätssicherungssystem in Übereinstimmung mit Anhang IV der Richtlinie entworfen und in Betrieb genommen hat. Die Anlagen werden alle Überwachten Produkte mit den Baumusterprüfprotokollen im Auditbericht Nr. ZQS/E310/16, ausgestellt am 21.12.2016, und die jährlichen Nachschauaudits des Qualitätssicherungssystems werden Bestandteil dieses Auditberichts sein.

Das Zertifikat ist ab dem 20.08.2016 bis 19.08.2019 und kann zurückgezogen werden, wenn die Anforderungen an die Qualitätssicherung nach Anhang IV und VII erfüllt sind.

Richtlinie 2014/34/EU ist hinter der CE-Kennzeichnung die Kennnummer der benannten Stelle anzugeben, die in der Phase der Produktion verwendet wird.

*Mark Huckhold*  
Fachzertifizierer

Seite 1 von 1  
Zertifikat darf nur vollständig und unverändert weiterverstreut werden.  
Tel: +49 224 3099-100, Telefax: +49 224 3099-110, zvs-cert@dekra.com

## 1.9 Components of a lightning and surge protection system

All lightning and surge protection systems are made up of the following elements:

### 1. Air-termination and down-conductor systems

Air-termination and down-conductor systems reliably arrest direct lightning strikes with energy of up to 200,000 A and conduct them safely into the earthing system.

### 2. Earthing systems

Earthing systems discharge approx. 50% of the arrested lightning current into the ground; the other half is distributed via the equipotential bonding.

### 3. Equipotential bonding systems

Equipotential bonding systems form the interface between external and internal lightning protection. They ensure that dangerous potential differences do not come about in the building

### 4. Surge protection systems

Surge protection systems form a multi-stage barrier which no surge voltage can break through.

*OBO can offer components for comprehensive lightning and surge voltage protection systems. Standard-compliant, tested components from OBO offer protection and safety of the highest order not just for homes but also for industrial plants and potentially explosive areas.*

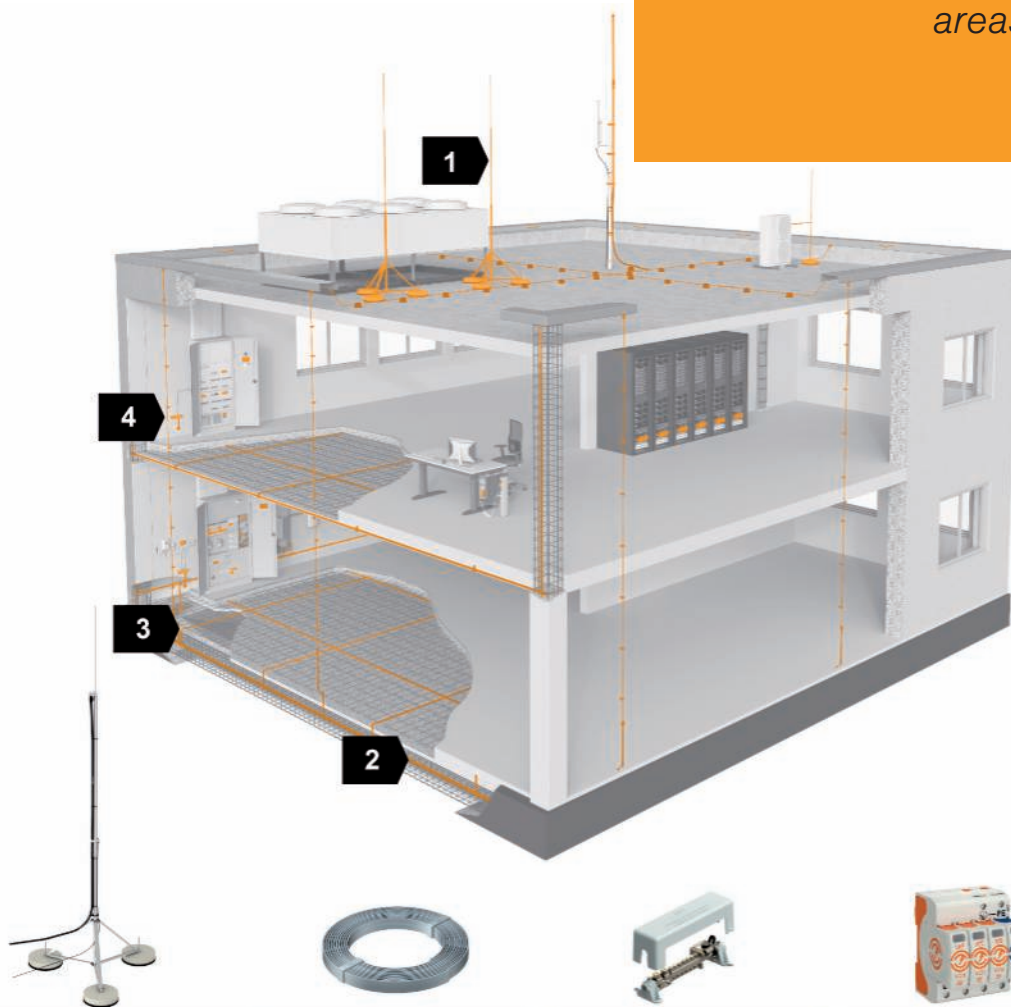

Components of a lightning and surge protection system



Type 2 surge protection device in the distribution

### 1.9.1 Surge protection as a part of equipotential bonding

In Germany, surge protection has been reregulated by the standards IEC 60364-4-44 and IEC 60364-5-53 and has been obligatory since October 2016. Electrical planners and installation engineers must inform clients of this necessity.

#### DIN VDE 0100-443: WHEN is surge protection necessary

On all newly planned buildings and changes or expansions to existing electrical systems.

#### DIN VDE 0100-534: HOW and WHICH measurements are required?

Surge protection is to be installed as close as possible to the supply point of the electrical system. If the distance between the surge protection device and the device to be protected involves a cable length of more than 10 metres, additional measures are required.

Surge protection prevents the insulation failure through high voltages and avoids fires due to short circuiting.

### Surge protection is mandatory in all building installations!

Insulation coordination must be carried out in all new or expanded electrical systems. Surge protection devices (at least type 2 or type 2+3) prevent an insulation failure, thus avoiding short circuits and fires.

#### Protection is mandatory for exposed cables!

Buildings supplied by exposed cables are at risk from partial lightning currents. This also applies if the supply cable is run between the last mast of the exposed cable and the building as an earth cable. For this reason, surge protection devices (type 1 or type 1+2) able to carry lightning current must be used at the supply point of the electrical system.

*IEC 60364-4-44: "The erection of surge protective devices (SPDs) should ensure a voltage limitation according to the insulation coordination, in order to avoid dangerous spark formation and resulting fires."*

# 2

The lightning current must be intercepted and arrested by the lightning protection system. In case of a direct strike, the lightning protection system protects the building against fire. The air-termination systems provide an optimal impact point and are connected to the earthing system via the conductors. For lightning currents, this creates a conductive path into the ground. The air-termination systems form protective spaces, the necessary size of which can be determined using, for example, the “rolling sphere method”.

Alongside the air-termination system and the conductors, the earthing system is another integral part of the external lightning protection system. The lightning current needs to be safely routed into the earthing system without any sparking or arcing into other metallic structures. The equipotential bonding system creates the connection into the building.

**IEC/EN 62305**  
+  
**State and model building regulations require lightning protection**

**IEC/EN 62305**  
+  
**DIN 18014**  
require  
**foundation earth electrodes**

**IEC/EN 60364-1**  
requires protection  
against  
**electric shocks**

## Chapter 2: The external lightning protection system

2.	The external lightning protection system	57
2.1	Air-termination systems	57
2.1.1	Planning methods for air-termination systems	58
2.1.1.1	Rolling sphere method	59
2.1.1.2	Protective angle method	63
2.1.1.3	Mesh method	65
2.1.1.4	Protection against lateral impact	66
2.1.2	Changes in length due to temperature	67
2.1.3	External lightning protection for roof structures	67
2.1.4	Use of natural components	68
2.1.5	Separation distance	71
2.1.6	Wind load	76
2.1.7	Types of air-termination systems	81
2.1.7.1	Insulated, high-voltage-resistant air-termination systems	81
2.1.7.1.1	Insulated air-termination masts with external isCon® conductor	82
2.1.7.1.2	Insulated air-termination rods with internal isCon® conductor	82
2.1.7.2	Isolated air-termination systems	84
2.1.7.2.1	Aluminium air-termination rods	84
2.1.7.2.2	Tele rod systems	85
2.1.7.2.3	GRP rods	86
2.1.7.3	Installation principle, building with flat roof	88
2.1.7.4	Installation principle for a building with a pitched/gabled roof	92
2.2	Down-conductors	96
2.2.1	Planning methods	97
2.2.1.1	Number and arrangement	97
2.2.2	Fastening principles	99
2.2.3	Fastening substrates	100
2.2.3.1	Concrete	101
2.2.3.2	Masonry	102
2.2.4	Distances and setting depth	103
2.2.5	Failure criteria	104
2.2.6	Types of anchors	105
2.2.7	Fastening on steel structures	108
2.2.8	Fastenings on wooden components	109
2.2.9	Use of natural components	112
2.2.10	Equipotential areas as reference layer	114
2.2.11	High-voltage-resistant, insulated conductor	115
2.2.12	Versions	117
2.2.12.1	Non-isolated lightning protection system	117
2.2.12.2	Isolated lightning protection system	117
2.2.12.3	High-voltage-resistant, insulated isCon® conductor	119
2.2.13	New technical specification IEC TS 62561-8	129
2.2.13.1	Problem	129
2.2.13.2	Insulated external lightning protection system with insulators	131
2.2.13.3	Isolated external lightning protection system with insulated, high-voltage-resistant conductors	132
2.2.13.4	Potential control	134
2.2.13.5	Technical solution for an insulated high-voltage-resistant conductor	135
2.2.13.6	Type tests for insulated conductors	136
2.2.13.7	Summary	137
2.2.13.8	Selection aid, isCon® conductors	140
2.3	Lightning protection in potentially explosive areas	141
2.3.1	Basic principles	141
2.3.2	Assignment of the Ex zones	143
2.3.3	Solutions	145
2.4	Earthing systems	149

## Chapter 2: The external lightning protection system

2.4.1	Basic principles	150
2.4.2	Normative requirements	150
2.4.3	Planning methods	151
2.4.3.1	Type A earth rod structure	152
2.4.3.2	Type B ring earth electrodes	154
2.4.3.3	Type B foundation earth electrodes	156
2.4.4	Versions	159
2.4.4.1	Earth rods	160
2.4.4.2	Black trough	161
2.4.4.3	White trough	161
2.4.4.4	Perimeter insulation	162
2.4.5	OBO selection aid for foundation and ring earthers	165
2.5	OBO Construct planning aids	166
2.6	Potential control	167
2.6.1	Step voltage	168
2.6.2	Protection against dangerous touch voltage	168
2.7	Materials and corrosion protection	169
2.7.1	Materials for air-termination and conductor systems	170
2.7.2	Materials for earthing systems	172
2.8	Testing of lightning protection system components	173



## 2. The external lightning protection system

The external lightning protection system consists of air-termination systems, down-conductors and the earthing system. With these components it is able to perform the functions required of it, namely intercepting direct lightning strikes, discharging the lightning current to earth and distributing it in the ground.

### 2.1 Air-termination systems

Air termination systems are the part of the lightning protection system that protect the building structure from direct lightning strikes.

Air-termination systems can be comprised of any combination of the following components:

- Air-termination rods (including free-standing rods)
- Catenary wires
- Meshed conductors

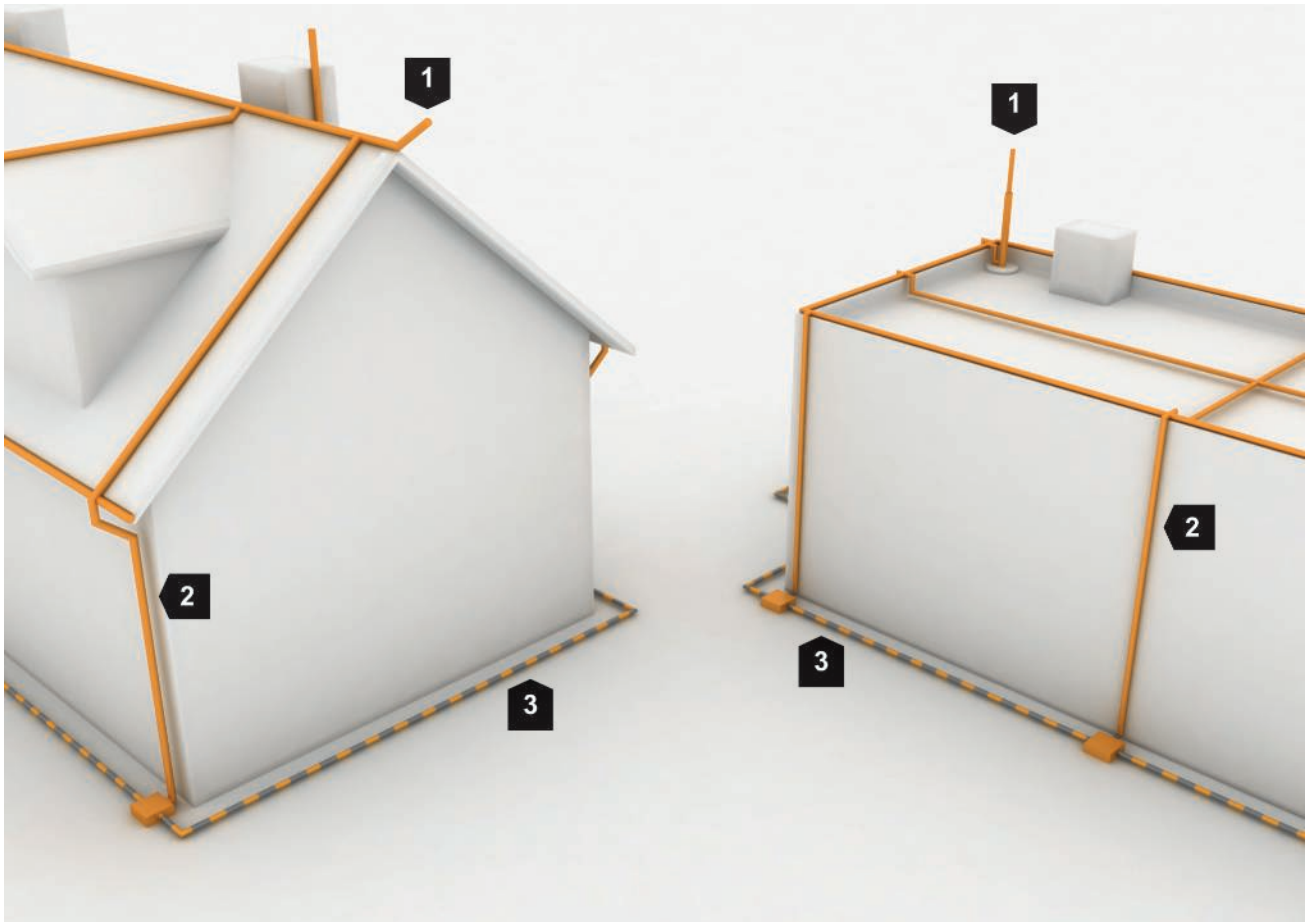

<b>1</b>	Air-termination system
<b>2</b>	Down-conductor
<b>3</b>	Earthing system

*Components of an external lightning protection system*

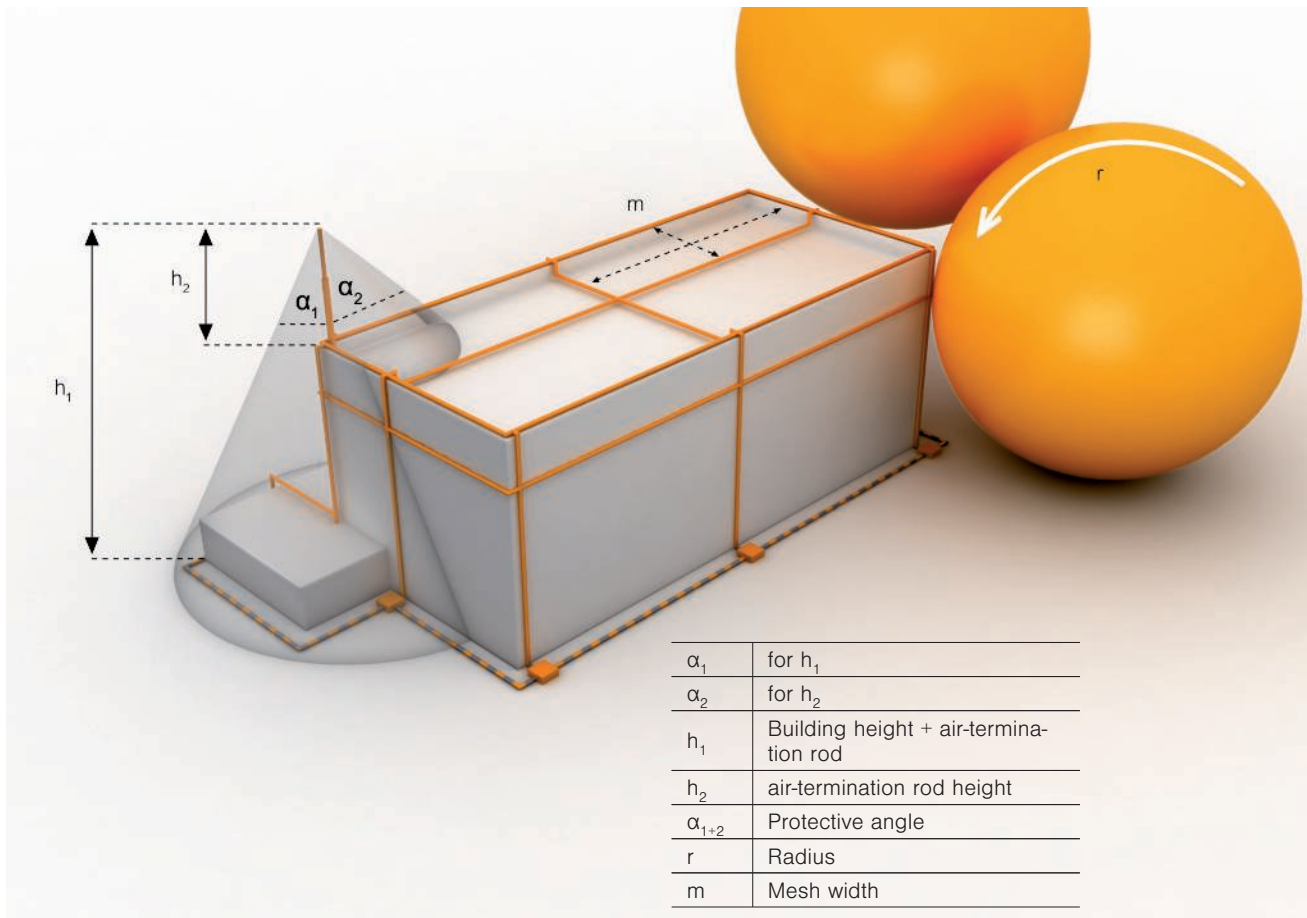

Designing a lightning protection system using the protective angle, mesh and rolling sphere methods

*The rolling sphere method is the only one of the methods for planning air-termination systems that is derived from the electrogeometric lightning model and founded on physical principles.*

*This is, therefore, the method that should be used where the protective angle or mesh method throw up uncertainties.*

### 2.1.1 Planning methods for air-termination systems

Following a practical assessment of the building, one or a combination of the following planning methods is selected:

- Rolling sphere method (particularly suitable for complex systems)
- Protective angle method (for simple planning tasks, e.g. for air-termination rods)
- Mesh method (for simple planning tasks, e.g. for flat roofs)

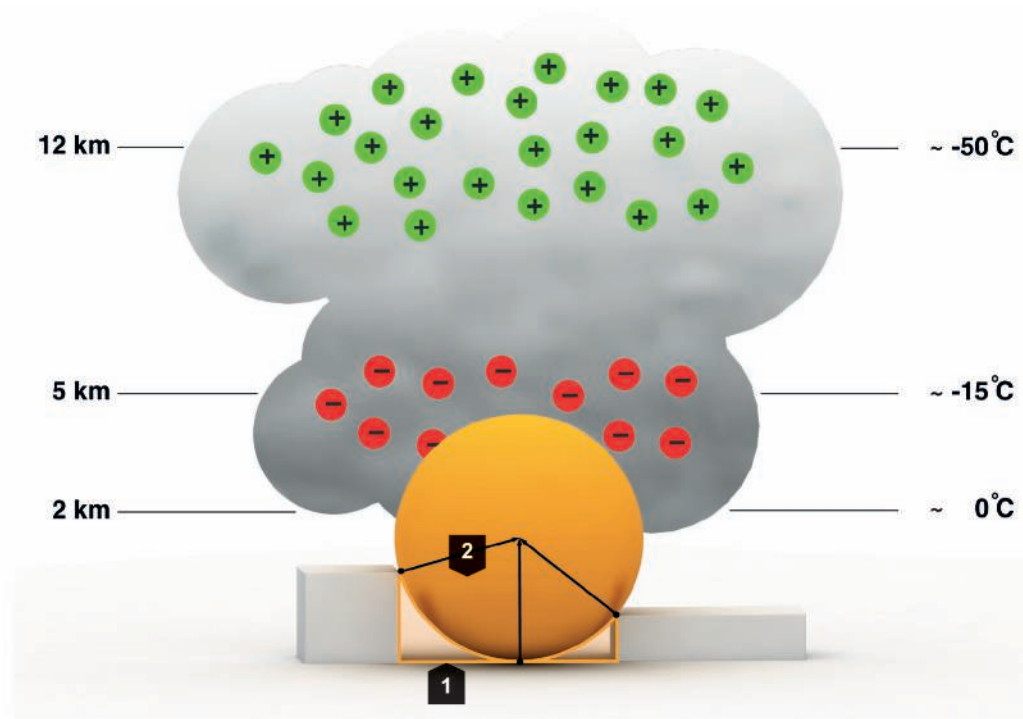

<b>1</b>	Protected area
<b>2</b>	Area exposed to strike

*Electrogeometric lightning model/rolling sphere method*

### 2.1.1.1 Rolling sphere method

Charge separation causes a potential difference between the clouds and the ground, producing a stepped leader. Connecting discharges are launched towards the tip of the stepped leader from various points such as trees, houses and antennas. At the point where the interception discharge is first reached by the tip of the stepped leader, a strike occurs. It is therefore necessary to protect all points on the surface of a ball with the radius of the striking distance, and with the tip of the stepped leader as its centre, against direct lightning strike. This ball will be referred to here as the “rolling sphere”. The radius of the rolling sphere depends on the lightning protection class of the buildings that are to be protected.

The lightning current must be intercepted and arrested by the lightning protection system. In case of a direct strike, the lightning protection system protects the building against fire. The air-termination systems provide an optimal impact point and are connected to the earthing system via the conductors. For lightning currents, this creates a conductive path into the ground. The air-termination systems form protective spaces, the necessary size of which can be determined using, for example, the “rolling sphere method”.

The rolling sphere radius, together with the minimum current peak values relative to the appropriate lightning protection class, form the electrogeometric model (EGM), which is the only physically recognised basic model for the creation of a lightning protection concept according to IEC/EN 62305-1.

Other, theoretical models, which only allow small areas with greater peak current values than named in IEC/EN 62305-1, may not be used for planning of a lightning protection system recognised in the standard. Their reproducible effectiveness could not be proven by recognised scientific methods. The protection methods, which are specified in more detail in IEC/EN 62305-3 and IEC/EN 62305-4, only offer effective protection against lightning strikes whose current technical values are in the area between the maximum and minimum peak current values defined by the lightning protection class (see following table).

*The rolling sphere rolls over the building; everywhere it makes contact is a possible impact point for the lightning.*

Risk level (LPL = lightning protection level)	Radius of rolling sphere	Smallest peak current value in kA	Max. peak current value in kA
I	20 m	3	200
II	30 m	5	150
III	45 m	10	150
IV	60 m	16	100

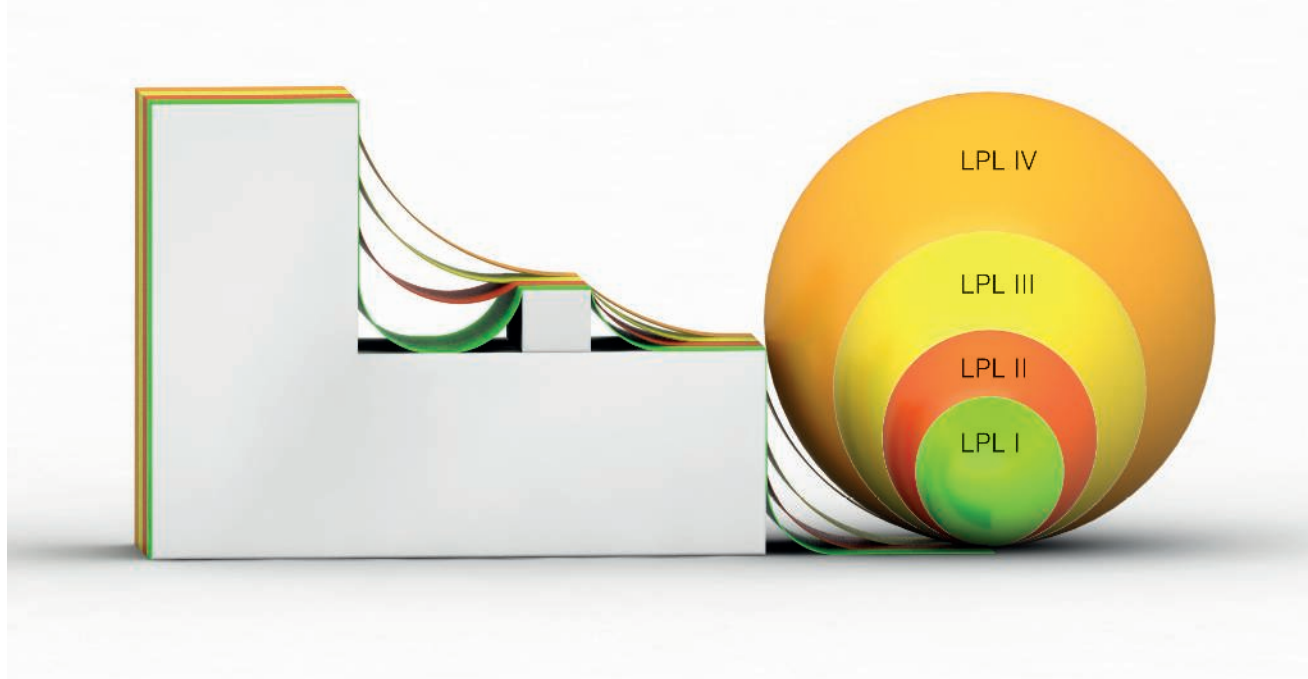

Radius of rolling sphere for different lightning protection classes

Modern CAD programs can reproduce in 3D the rolling sphere rolling over the entire installation that is to be protected. For example, in buildings of lightning protection class I, the ball touches surfaces and points that in buildings of lightning protection class II (or III or IV) would still be in the protected area. The rolling sphere method allows the installation to be divided into different external lightning protection zones (LPZs) or "lightning protection levels" (LPLs):

**LPZ 0<sub>A</sub>**

Hazards from direct lightning strikes and the entire electromagnetic field of the lightning.

**LPZ 0<sub>B</sub>**

Protected against direct lightning strikes, but at risk from the entire electric field of the lightning.

**Note**

Lateral impacts can occur on any building structures higher than the radius of the rolling sphere. However, the probability of a lateral impact is negligible on building structures with a height of less than 60 m.



Rolling sphere method and the resulting lightning protection zones (LPZs)

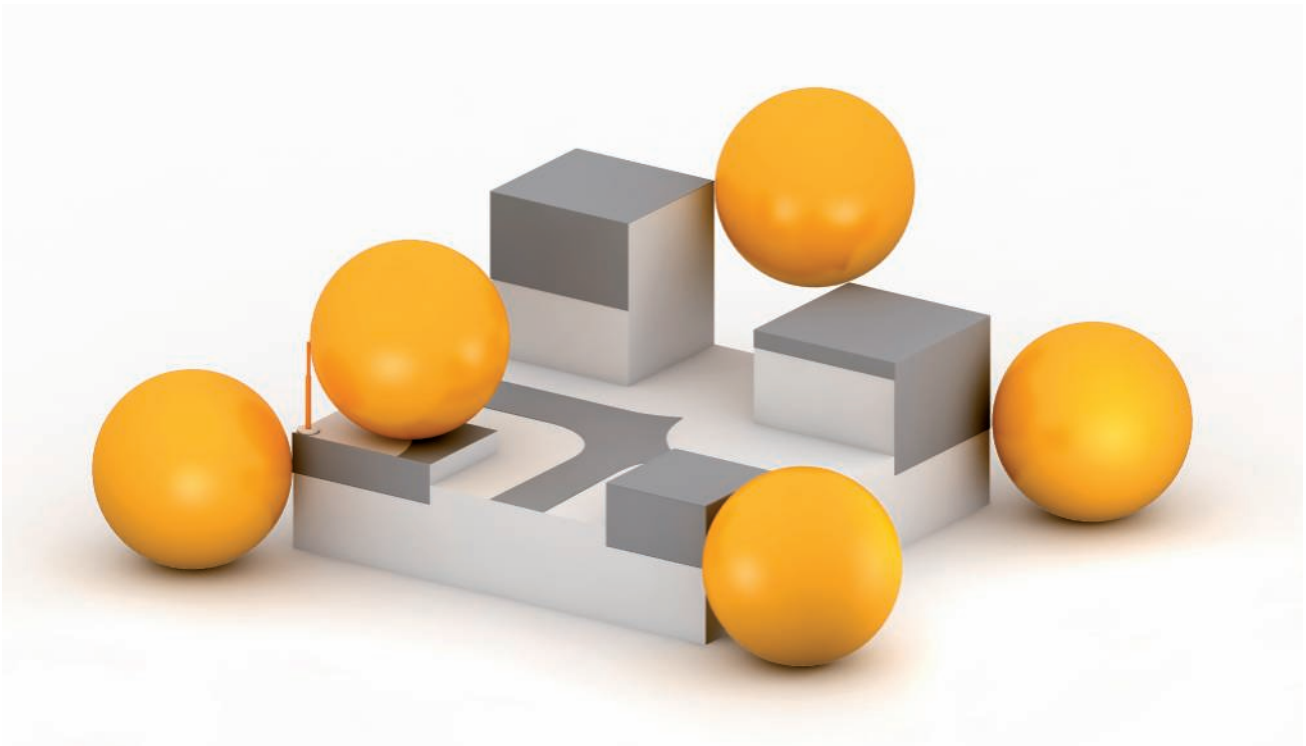

Rolling sphere method (dark grey areas are areas at risk of strike)

The building that is to be protected must be fitted with air-termination systems in such a way that a sphere with a radius determined on the basis of the lightning protection class cannot touch the building. Air-termination systems are required in the dark grey areas.

The rolling sphere method can be used to determine the required lengths of air-termination rods and the distances between them. The air-termination rods must be arranged in such a way that all parts of the structure to be protected are located in the protection area of the air-termination system.

For all types of air-termination system, only the actual dimensions of the metallic air-termination system shall be taken into account during planning according to IEC/EN 62305-3. This should also be taken into account with all so-called "active" air-termination systems, such as ESE "Early Streamer Emission". Only the planning methods named in IEC/EN 62305-3 shall be used for planning. Others, such as the "Collection Volume Method" (CVM), are excluded by the standard.

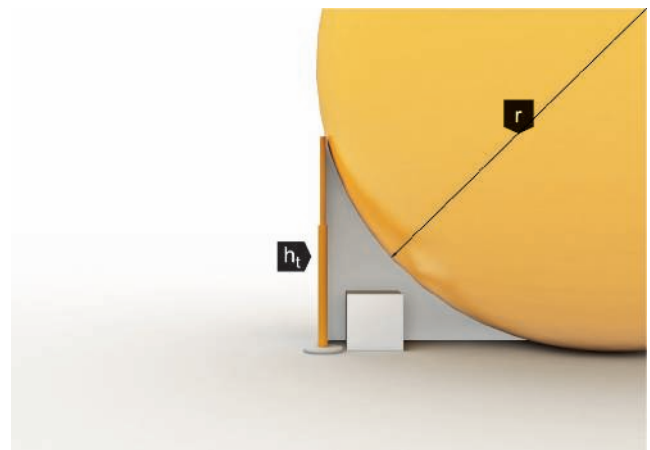

$h_t$	Air-termination rod
$r$	Rolling sphere radius

Protection area of an air-termination rod determined using the rolling sphere method

### Protecting roof structures using multiple air-termination rods

If you use several air-termination rods to protect an object, you must take into consideration the penetration depth between them. For a brief overview see Table 2.1, or to calculate the penetration depth use the following formula:

$$p = r - \sqrt{r^2 - \left(\frac{d}{2}\right)^2}$$

Formula for calculating the penetration depth

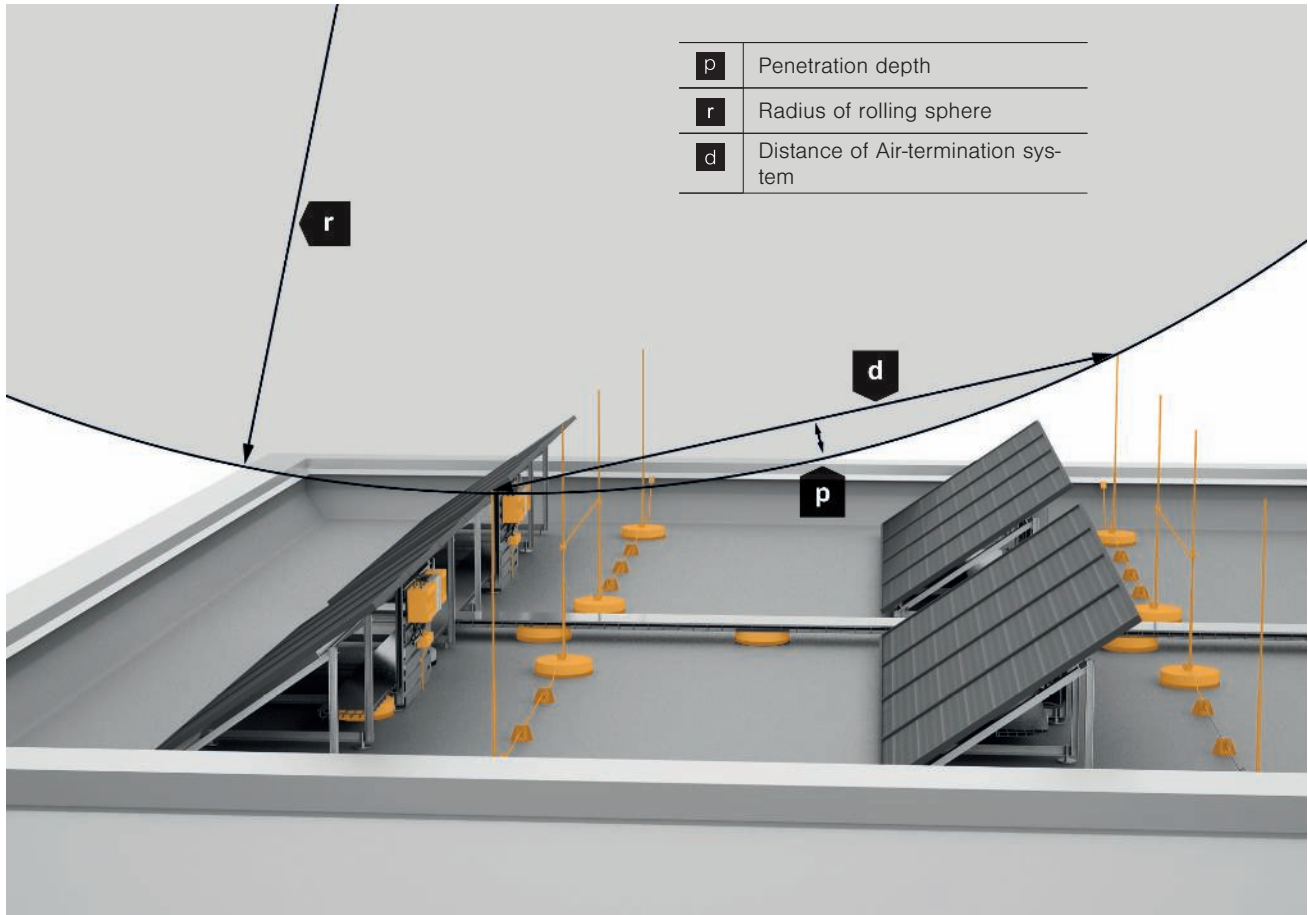

Penetration ( $p$ ) of the rolling sphere between the air-termination rods

Distance of air-termination system ( $d$ ) in m	Penetration depth, lightning protection class I, rolling sphere: $r = 20$ m	Penetration depth, lightning protection class II, rolling sphere: $r = 30$ m	Penetration depth, lightning protection class III, rolling sphere: $r = 45$ m	Penetration depth, lightning protection class IV, rolling sphere: $r = 60$ m
2	0.03	0.02	0.01	0.01
3	0.06	0.04	0.03	0.02
4	0.10	0.07	0.04	0.04
5	0.16	0.10	0.07	0.05
10	0.64	0.42	0.28	0.21
15	1.46	0.96	0.63	0.47
20	2.68	1.72	1.13	0.84

Table 2.1: Penetration depth ( $p$ ) according to the lightning protection class according to IEC 62305

$\alpha$	Protective angle
s	Separation distance

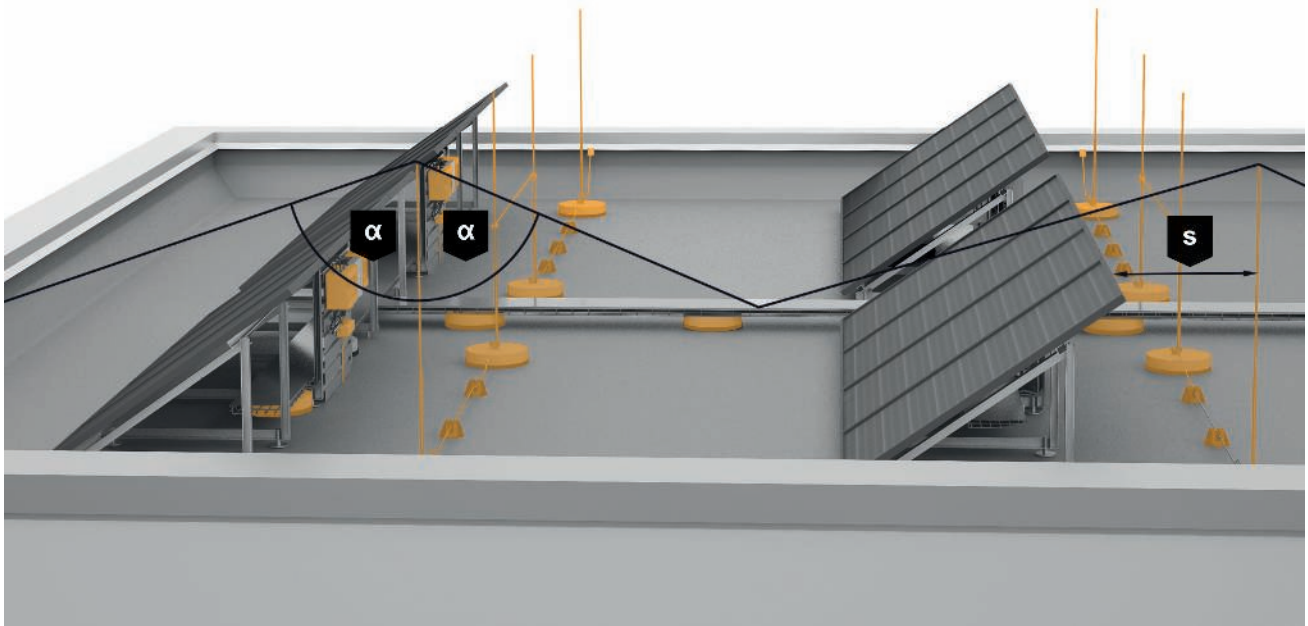

Protective angle and separation distance of air-termination rods in a photovoltaic system

### 2.1.1.2 Protective angle method

Using the protective angle method is only advisable in simple or small buildings and for individual sections of buildings.

This method should therefore only be used where the building is already protected with air-termination rods whose positions were determined using the rolling sphere or grid method. The protective angle method is well suited to determining the positions of air-termination rods providing merely additional protection for a small number of protruding building parts or structures.

All roof structures must be protected with air-termination rods. Here it is necessary to observe the relevant separation distance (“s”) between earthed roof structures and metal systems.

If the roof structure has a conductive continuation into the building (e.g. with a stainless steel pipe with a connection to the ventilation or air-conditioning system), then the air-termination rod must be erected at a separation distance of (s) from the object to be protected. This distance safely prevents arcing of the lightning current and dangerous spark creation.

*Using the protective angle method is only advisable in simple or small buildings and for parts of buildings.*

$\alpha$	Protective angle
1	LPZ 0 <sub>A</sub> : Danger posed by direct lightning strikes
2	LPZ 0 <sub>B</sub> : Protected from direct lightning strikes but at risk
3	$h_1$ : Air-termination rod height
4	$r_z$ : Radius of the protected area
5	Z: Height of the protected area

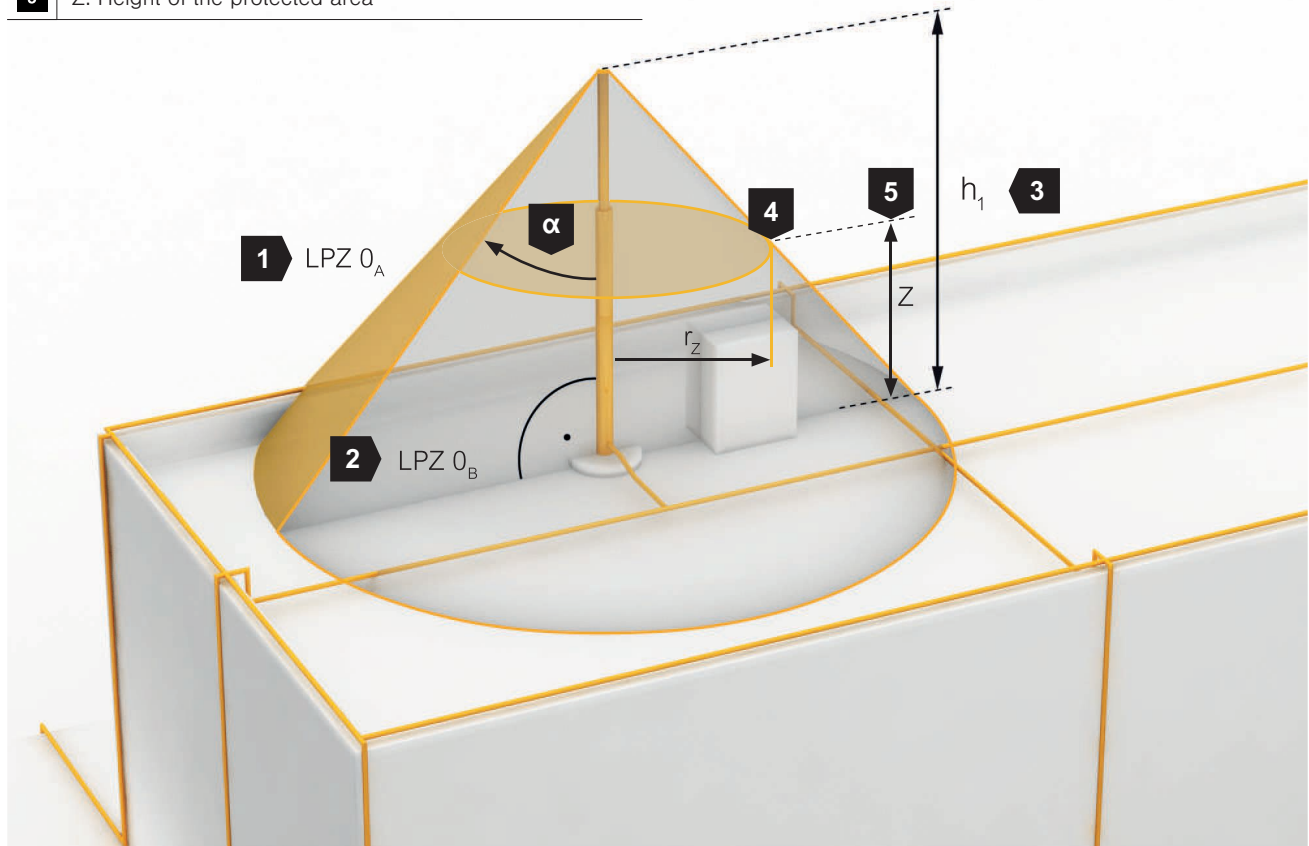

Protected area of an air-termination rod calculated with the simplified protective angle method

The protective angle ( $\alpha$ ) for air-termination rods varies according to lightning protection class. You can find the protective angle ( $\alpha$ ) in the table for the most common air-termination rods of up to 2 m in length. (Table 2.2)

The structure to be protected (e.g. building part or device) must be fitted with one or several air-termination rods in such a way that the structure fits fully underneath a cone sheath formed by the tips of the air-termination rods and whose top angle is taken from the table. The areas bordered by the horizontal plane (roof surface) and the areas enclosed by the cone sheath can be considered protected areas.

Should the height of the roof object to be protected be known, then the formula:

$$r_z = (h_1 - z) \times \tan(\alpha)$$

can be used to determine the protection area of the air-termination rod or a formula conversion can be used to determine the required air-termination rod length.

Lightning protection class	Protective angle $\alpha$ for air-termination rods up to 2 m in length
I	70°
II	72°
III	76°
IV	79°

Table 2.2: Protective angle based on lightning protection class according to IEC 62305-3 for air-termination rods up to 2 m in length



l	Building length
m	Mesh width

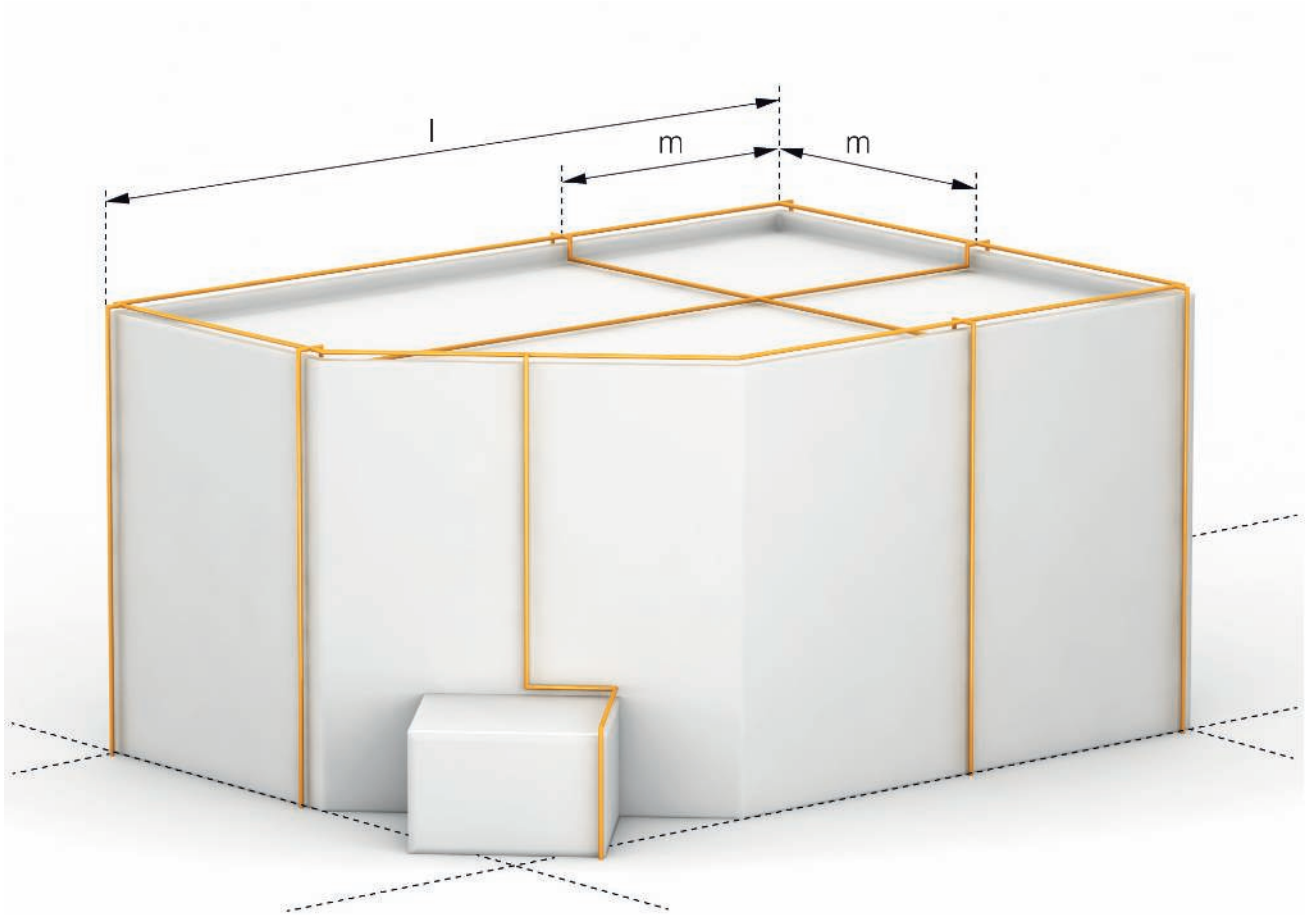

Grid system on a flat roof

### 2.1.1.3 Mesh method Installing the loops

A number of different loop sizes are suitable for the particular lightning protection class of the building. The building in our example has building lightning protection class III. A loop size of 15 m x 15 m must therefore not be exceeded. If, as in our example, the overall length  $l$  is greater than the recommended size indicated in Table 2.3, an expansion piece must also be integrated for temperature-controlled length changes.

*The mesh method is used exclusively on the basis of the lightning protection class.*

Class	Mesh width
I	5 x 5 m
II	10 x 10 m
III	15 x 15 m
IV	20 x 20 m

Table 2.3: Mesh widths for different lightning protection classes

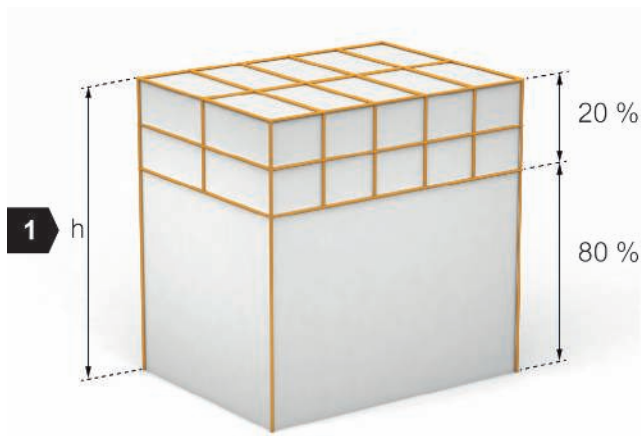

<b>1</b>	Building height (h) > 60 m
----------	----------------------------

Mesh method and protection against lateral impact

### Protection against lateral impact

From a building height of 60 m and the risk of serious damage (e.g. with electrical or electronic devices) it is advisable to install a ring circuit to protect against lateral impact.

The ring is installed at 80% of the building's overall height, the loop size depends – as it does in the case of roof installation – on the lightning protection class, e.g. lightning protection class corresponds to a loop size of 15 x 15 m.

### Additional protection against lateral impacts under 60 m building height according to IEC CDV 62305-3:2018

Lateral impacts under 60 m building height can be regarded as insignificant. However, elements protruding over the building dimensions may be at risk (e.g. balconies, cameras, antennas, etc.).

When the lateral impact method is used, the positioning of the air-termination unit is sufficient when all the parts of the element to be protected are under a surface, which is created by a straight line with an angle of  $\alpha = 15^\circ$  to the vertical. The horizontal width of the protected area is limited to  $w = r/10$  m. Here, the parameter  $\alpha$  is independent of the LPS class.

This method will only be standardised from Edition 3 of IEC 62305-3 if it finds sufficient approval. Until then, it should only be regarded as informative.

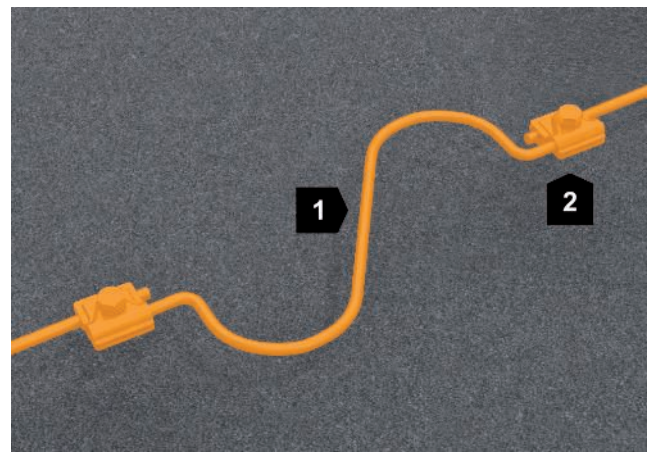

<b>1</b>	Expansion piece
<b>2</b>	Terminal

Lightning protection mesh with expansion piece

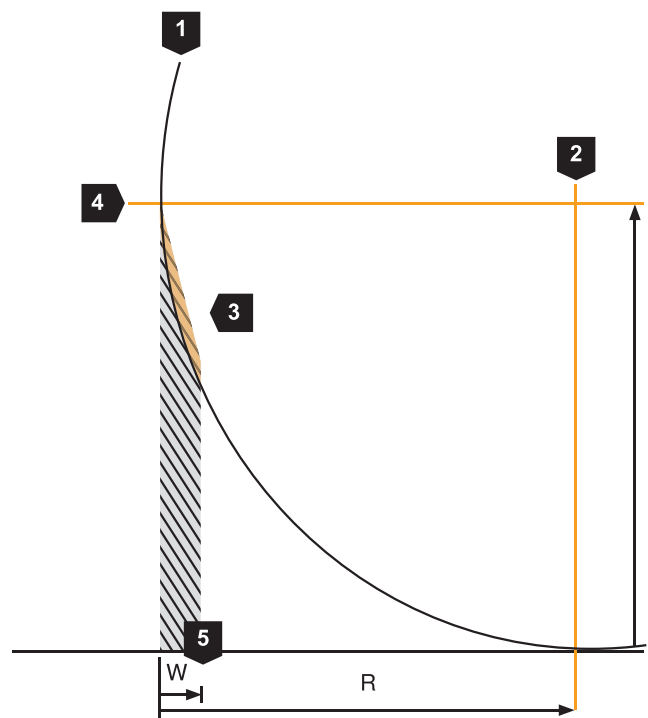

<b>1</b>	Arc of the rolling sphere
<b>2</b>	Centre of the rolling sphere
<b>3</b>	Protected volume due to the protection angle ( $15^\circ$ )
<b>4</b>	Height of the mounted air-termination rod $\leq 60$ m
<b>5</b>	$W = R/10$

Additional protection against lateral impacts

### 2.1.2 Changes in length due to temperature

At higher temperatures, e.g. in summer, the length of the air-termination systems and down-conductors changes. These temperature-related changes in length must be taken into account during installation. Expansion pieces must allow a flexible response to changes in length, either through their shape (e.g. S shape), or because they are flexible lines. For practical purposes, the expansion piece spacings listed in Table 2.4 have proved to be effective.

Material	Expansion piece spacing in m
Steel	≤ 15
Stainless steel	≤ 10
Copper	≤ 10
Aluminium	≤ 10

Table 2.4: Expansion pieces to compensate changes in length due to temperature

### 2.1.3 External lightning protection for roof structures

Roof structures must be incorporated into the external lightning protection system according to IEC 62305-3 if they exceed the dimensions stated in Table 2.5.

Roof structures	Dimensions
Metal	0.3 m above roof level 1.0 m <sup>2</sup> total area 2.0 m length of the structure
Non-metal	0.5 m above the air-termination system

Table 2.5: Incorporation of roof structures

*Smoke and heat extraction roof light domes must be protected from direct lightning strikes. Surge protection devices protect the electrical drives of these devices from damage due to inductive coupling.*



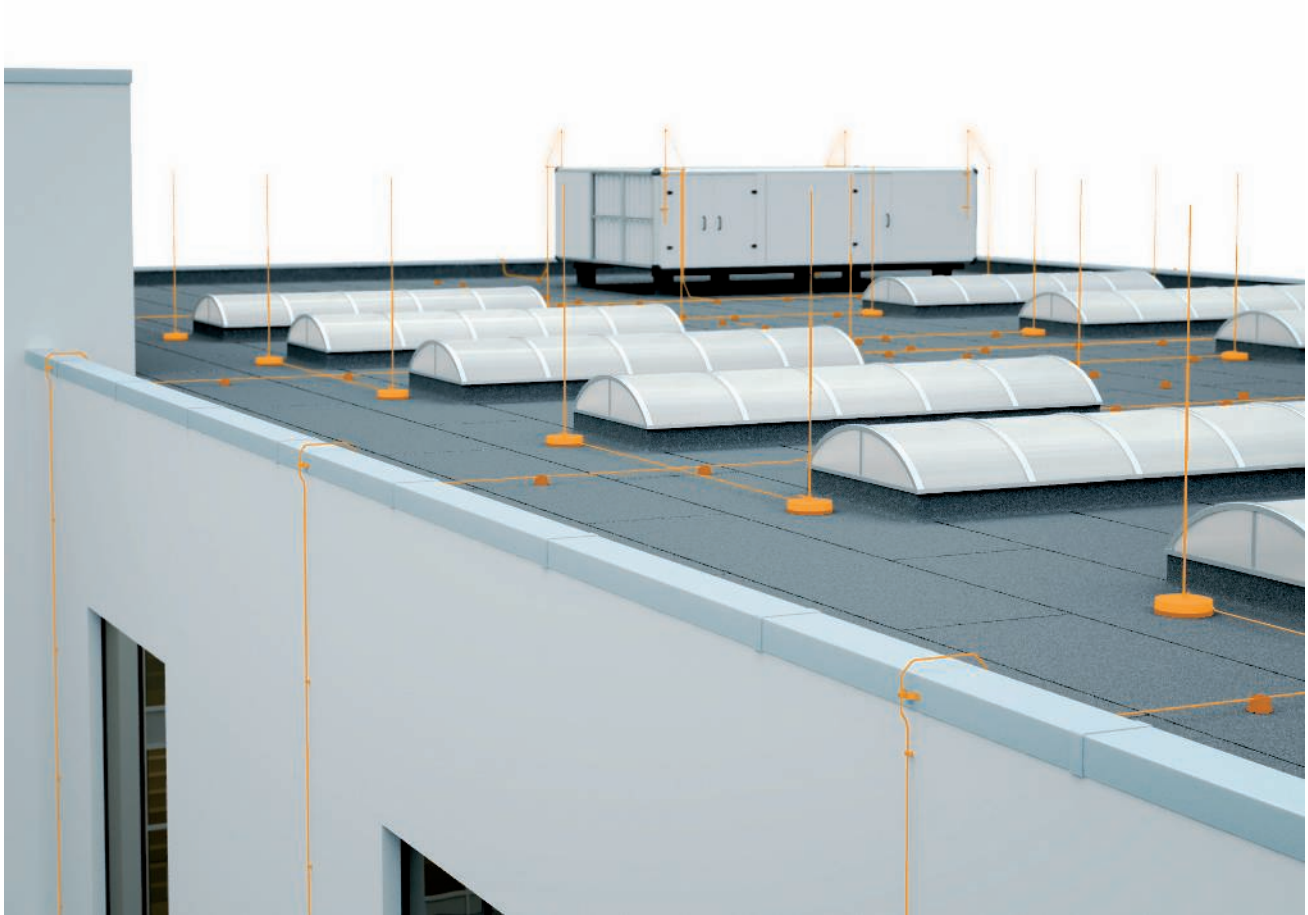

Natural components (here: metal of roof parapet) for air-termination systems, IEC 62305-3

#### 2.1.4 Use of natural components

If there are conductive elements on the roof, it can make sense to use these as natural air-termination systems.

Examples of natural components for air-termination systems according to IEC 62305-3 can include:

- Panelling with metal plate (e.g. parapet)
- Metallic components (e.g. supports, through connected reinforcement)
- Metal parts (e.g. rain gutters, ornamentation, railings)
- Metallic pipes and tanks

Electrical continuity between the various parts must be permanently guaranteed (e.g. through hard soldering, welding, crushing, beading, screwing or riveting). What is essential is that there is no conductive connection into the building interior. In this case, the lightning protection class is irrelevant to the selection of a natural air-termination system.

#### Characteristic data that apply irrespective of the protection class:

- Minimum thickness of metal plates or pipes on air-termination systems
- Materials and their conditions of use
- Materials, shape and minimum dimensions of air-termination systems, down-conductors and earthers
- Minimum dimensions of connection cables



Possible method for connecting metal on roof parapet by bridging with a flexible cable

Various bridging and connecting components are available for connecting metal roof elements (e.g. parapets) in such a way that they can conduct lightning current. Depending on the product, these can be fitted to the roof element in a standard-compliant way. The application standard offers a variety of options in this regard.

Metal covers to protect the exterior wall can be used as a natural component of the air-termination system, if melting at the impact point of the lightning strike is accepted (Table 2.6).

Metal roofs fulfilling the requirement of IEC/EN 62305-3 regarding material strength can be used as a natural air-termination and down-conductor unit. Tested terminals must be used to create a fixed connection able to carry lightning current. By contrast, loose conductor routing must be installed to secure the temperature-dependent length compensation.

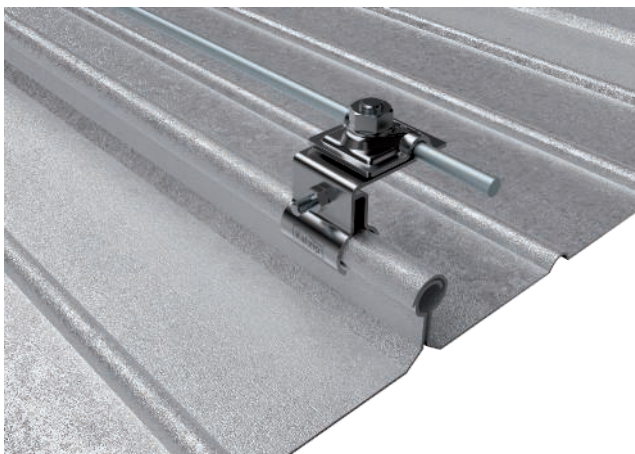

Kalzip® terminal, able to carry lightning current, from OBO

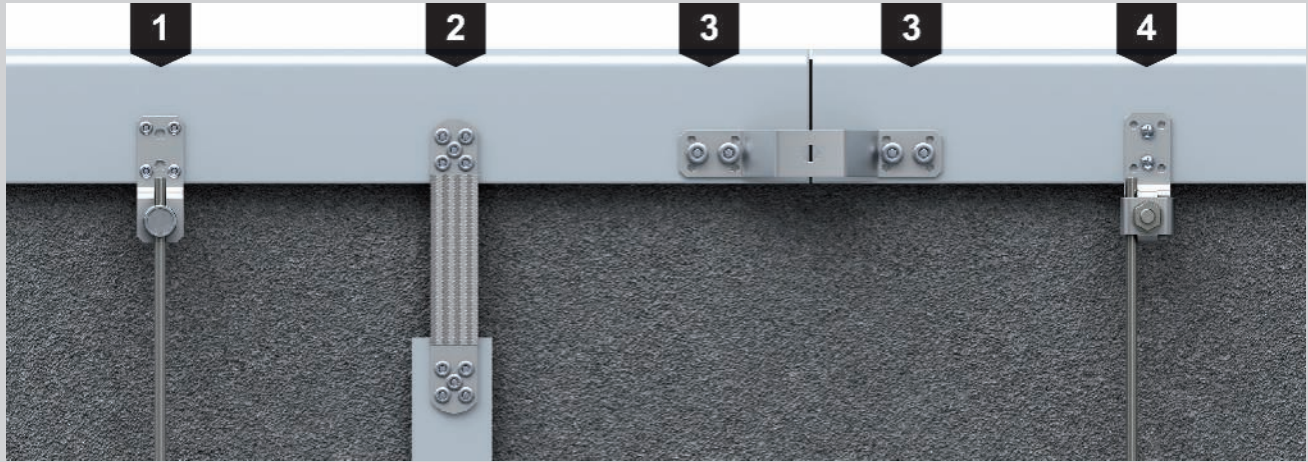

Screw connection on metal cover of roof parapet, source IEC 62305-3, Supplement 1:2012-10

<b>1</b>	4 blank rivets of 5 mm diameter
<b>2</b>	5 blank rivets of 3.5 mm diameter
<b>3</b>	2 blank rivets of 6 mm diameter
<b>4</b>	2 metal self-tapping screws of 6.3 mm diameter, made of rust-proof steel, e.g. material number 1.4301

Material	Thickness t mm (prevents penetration, overheating and inflammation)	Thickness t mm (if prevention of penetration, overheating and inflammation are not important)
Lead	-	2.0
Steel (rustproof/galvanised)	4	0.5
Titanium	4	0.5
Copper	5	0.5
Aluminium	7	0.65
Zinc	-	0.7

Table 2.6: Minimum thickness of metal plates or pipes on air-termination systems in accordance with IEC 62305-3, protection class (LPS): I to IV



Correctly maintained separation distance ( $s$ ) between down-conductor systems and roof structures

### 2.1.5 Separation distance ( $s$ )

All metallic parts of a building and electrically powered equipment and their supply cables must be integrated into the lightning protection system. This measure is required to avoid dangerous sparking between both air-termination system and down-conductor and also the metallic building parts and electrical equipment.

#### What is the separation distance?

If there is an adequate distance between the conductor passing from the lightning current and the metallic building parts, the risk of sparking is practically non-existent. This distance is described as the separation distance ( $s$ ).

The separation distance ( $s$ ) does not prevent inductively coupled surge voltages!

### Components with direct connection to lightning protection system

A separation distance does not have to be observed in buildings with cross-connected, reinforced walls and roofs or with cross-connected metal facades and metal roofs. Metallic components with no conductive lead into the building to be protected, and whose distance to the conductor of the external lightning protection system is less than one metre, must be connected directly to the lightning protection system. These include, although are not limited to, metallic railings, doors, pipes (with non-flammable and/or explosive content), facade elements, etc.

# Variants of insulated lightning protection

## 1.

### Maintaining the separation distance (s) without a mechanical connection

Numerous air-termination rods and systems from our portfolio can be used to maintain the separation distance. These products allow the implementation of the separation distance through the air to the building to be protected.

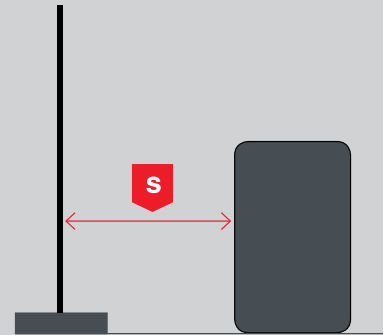

Mounting with air-termination rods or systems

## 2.

### Maintaining the separation distance (s) with a mechanical connection

However, should a direct mechanical connection to the building to be protected be required due to the project or reasons of economy, then the insulated systems of the OBO "101" series can be used.

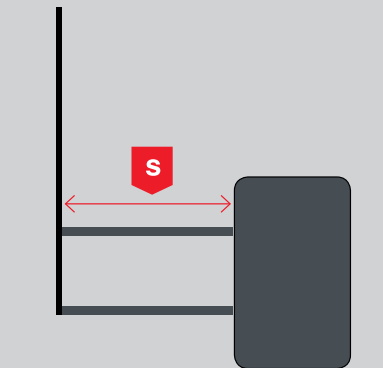

Mounting with GFRP insulating beam

## 3.

### Maintenance of the equivalent separation distance ( $s_e$ )

Our high-voltage-resistant, insulated conductor isCon® fulfills the requirements of IEC/ EN 62305 for an insulated lightning protection system. It is particularly useful if it is interesting from an architectural point of view or if a necessary separation distance cannot be maintained. In this case, the isCon® conductor simulates the actual distance through air.

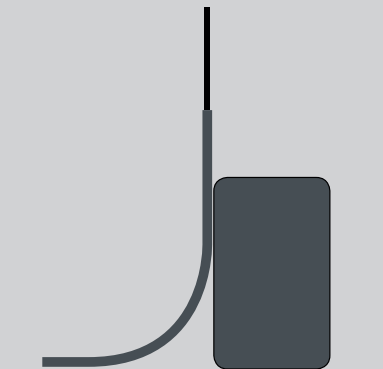

Mounting with isCon®



### The decisive factor: The separation distance (s)

All metallic parts of a building and electrical equipment and their supply cables must be integrated into the lightning protection system. This measure is required to avoid dangerous sparking between both the air-termination system and conductor and also the metallic building parts and the electrical installation. If there is an adequate distance between the conductor passing from the lightning current and the metallic building parts, the risk of sparking is practically non-existent. This distance is described as the separation distance (s).





Lightning down-conductor at a downpipe



Direct connection of PV mounting frames to the lightning protection down-conductor system

### Application example 1: Lightning protection

#### Situation

Metallic structures such as mounting frames, grilles, windows, doors, pipes (with non-flammable and or explosive contents) or facade elements with no conductive connection into the building.

#### Solution

Connect the lightning protection system with the metallic components.

*Active lines leading into the building can carry partial lightning currents, also when there is an isolated lightning protection system installed active lightning protection system. There must be lightning protection equipotential bonding at the entrance to the building.*

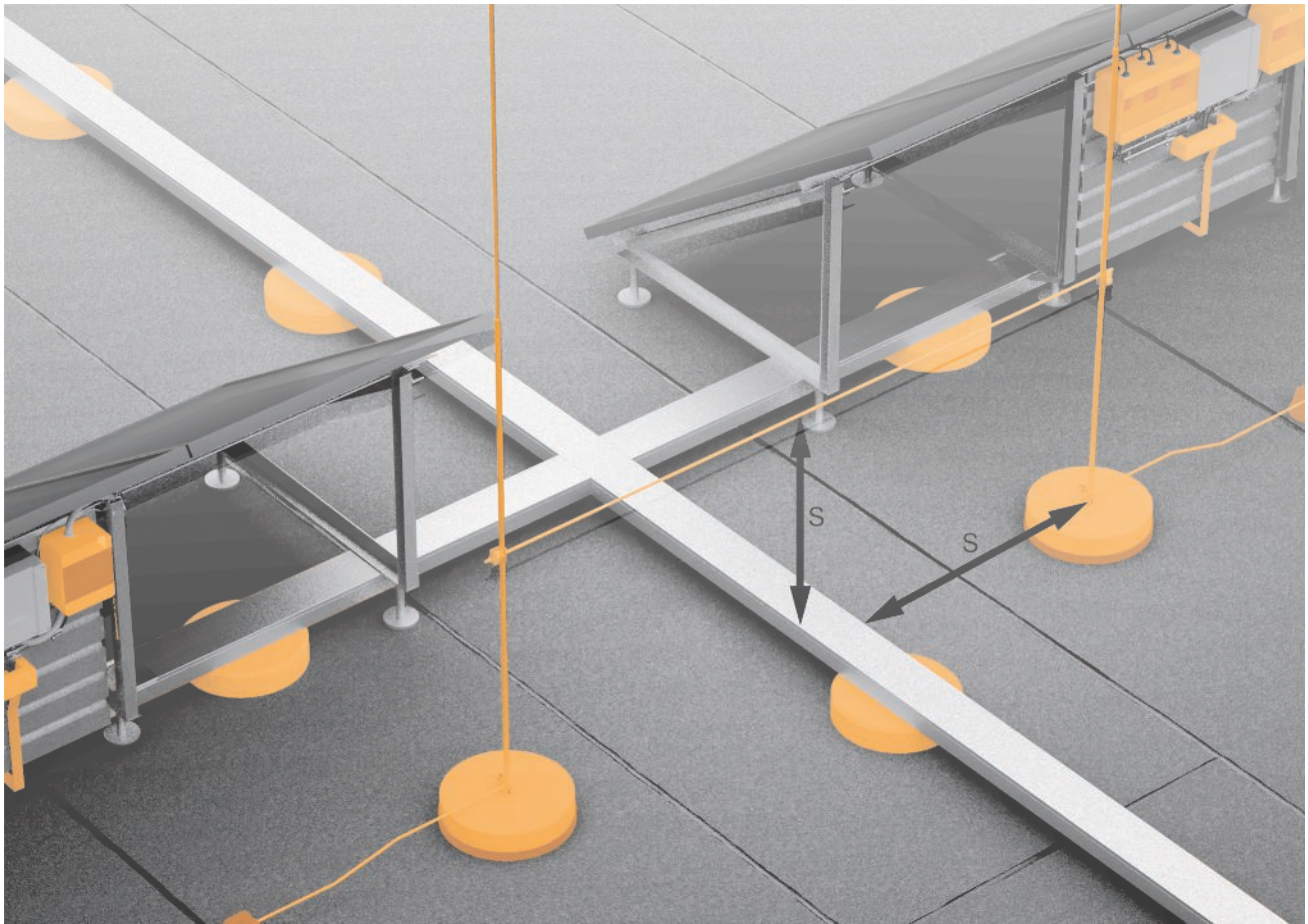

Isolated lightning protection with correctly maintained separation distance (s)

### Application example 2: Roof structures

#### Situation

Air-conditioning systems, photovoltaic systems, electrical sensors/actuators or metallic vent pipes with conductive connection into the building.

#### Solution

Isolation through the use of a separation distance (s)

#### Note

Risk of inductively coupled surges must be considered.

$$s = k_i \frac{k_c}{k_m} L(m)$$

$k_i$	Dependent on the selected protection class of the lightning protection system
$k_c$	Dependent on the (partial) lightning current that flows into the conductors
$k_m$	Dependent on the material of the electrical insulation
$L(m)$	Vertical distance from the point at which the separation distance (s) is to be calculated up to the closest point of the equipotential bonding

Formula for calculating the separation distance

### Procedure for calculating the separation distance according to DIN EN 62305-3

1st step Calculate the value of the coefficient $k_i$	<ul style="list-style-type: none"> <li>Protection class I: <math>k_i = 0.08</math></li> <li>Protection class II: <math>k_i = 0.06</math></li> <li>Protection classes III and IV: <math>k_i = 0.04</math></li> </ul>
2nd step Calculate the value of the coefficient $k_c$ (simplified system)	<ul style="list-style-type: none"> <li>1 conductor (only in the case of an isolated lightning protection system): <math>k_c = 1</math></li> <li>2 conductors: <math>k_c = 0.66</math></li> <li>3 conductors and more: <math>k_c = 0.44</math></li> </ul> <p>The values apply to all type B earthers and to those type A earthers in which the earther resistance of the neighbouring earther electrodes does not differ by more than a factor of 2. If the earther resistance of individual electrodes deviates by more than a factor of 2, <math>k_c = 1</math> should be assumed.</p>
3rd step Calculate the value of the coefficient $k_m$	<ul style="list-style-type: none"> <li>Material air: <math>k_m = 1</math></li> <li>Material concrete, brickwork: <math>k_m = 0.5</math></li> <li>OBO GFK insulating rods: <math>k_m = 0.7</math></li> </ul> <p>If several insulating materials are used, in practice the lowest value for <math>k_m</math> is used.</p>
4th step Calculate the value L	L is the vertical distance from the point at which the separation distance (s) is to be calculated up to the closest point of the equipotential bonding.

Table 2.7: Calculating the separation distance according to IEC 62305-3

#### Example: building structure

##### Initial situation:

- Lightning protection class III
- Building with more than four down-conductors
- Material: concrete, brickwork
- Height/point at which the separation distance should be calculated: 10 m

##### Value determined:

- $k_i = 0.04$
- $k_c = 0.44$
- $k_m = 0.5$
- $L = 10$  m

##### Calculation of separation distance:

$$s = k_i \times k_c / k_m \times L = 0.04 \times 0.44 / 0.5 \times 10 \text{ m} = 0.35 \text{ m}$$

*More detailed calculation methods for complex buildings and systems are described in IEC/EN 62305-3.*

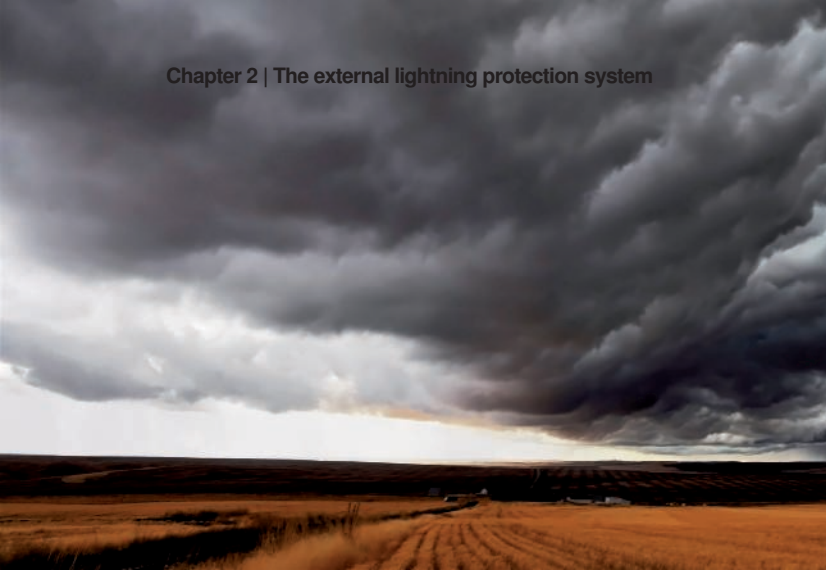

*The wind load describes the effect on buildings and installed systems. It must be taken into account during planning.*

### 2.1.6 Wind load

For decades, wind load has been an important consideration for OBO Bettermann in relation to external lightning protection. Today's calculation models and air-termination rod systems are the result of numerous studies and years of R&D experience.

The previous German standards in this area – DIN 1055:2005 Part 4: "Wind loads" and Part 5: "Snow and ice loads", and DIN 4131: "Steel antenna mounts" – dealt with all load assumptions for support structures in Germany.

The Eurocodes (EC) are the result of European standardisation in the construction field. EC 0 to EC 9 cover the documents in the series DIN EN 1990 to 1999. These are supplemented by the various national annexes (NA). The NAs contain provisions that go beyond the Eurocode rules, i.e. the provisions that were previously part of the national standards.

Following the publication of the national annexes to the ECs, the old standards became invalid, following appropriate coexistence phases (Table 2.8).

Old standard	New standard
Eurocode 1: DIN EN 1991-1-4:2010-12: Parts 1-4: General effects; wind loads + DIN EN 1991-1-4/NA: 2010-12	Eurocode 1: DIN EN 1991-1-4:2010-12: Parts 1-4: General effects; wind loads + DIN EN 1991-1-4/NA: 2010-12
DIN EN 1991-1-3: 2010-12 -; Parts 1-3: General effects; snow loads + DIN EN 1991-1-3/NA: 2010-12	DIN EN 1991-1-3: 2010-12 -; Parts 1-3: General effects; snow loads + DIN EN 1991-1-3/NA: 2010-12
Eurocode 3: DIN EN 1993-3-1: 2010-12: Parts 3-1: Towers, masts and chimneys – Towers and masts + DIN EN 1993-3-1/NA: 2010-12	Eurocode 3: DIN EN 1993-3-1: 2010-12: Parts 3-1: Towers, masts and chimneys – Towers and masts + DIN EN 1993-3-1/NA: 2010-12

Table 2.8: Example: German national standards for the calculation of wind load

**1st step: determining the wind zone**

The second factor that needs to be known when determining the wind load is the wind load zone in which the object is located. (Table 2.9)

The standards contain no statements regarding the following aspects:

- Framework masts and towers with non-parallel main legs
- Guyed masts and chimneys
- Cable-stayed and suspension bridges
- Torsional vibrations



Zone	Wind speed in m/s	Speed pressure in kN/m <sup>2</sup>
1	22.5	0.32
2	25.0	0.39
3	27.5	0.47
4	30.0	0.56

Table 2.9: Basic speeds and speed pressures (state-specific data)

Wind zones in Germany as per DIN EN 1991-1-4 NA (country-specific)

**2nd step: Determining the terrain category (TC)**

Terrain-specific loads and dynamic pressures are the second factor in calculating wind loads (Table 2.10).

Terrain category (TC)	Definition
Terrain category I	Open sea; lakes with at least 5 km of open water in the wind direction; even, flat land without obstacles
Terrain category II	Terrain with hedges, individual farmsteads, buildings or trees, e.g. agricultural area
Terrain category III	Suburbs, industrial or commercial areas; forests
Terrain category IV	Urban areas in which at least 15% of the area is built up with buildings whose average height is higher than 15 m

Table 2.10: Terrain categories according to DIN EN 1991-1-4

**3rd step: Determining the maximum gust speed**

The tilt and slip resistance of air-termination rods must always be determined on a project-by-project basis. The reference height is the building height and two thirds of the length of the air-termination rod. The maximum gust speed at the project location must be determined.

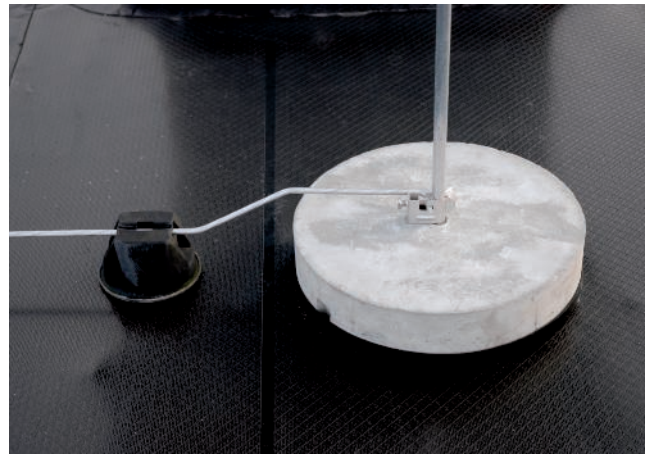

*Air-termination rod*

**Gust speed in wind zone I**

Reference height in metres	TC I in kph	TC II in kph	TC III in kph	TC IV in kph
0	112	105	100	93
5	122	108	100	93
10	136	124	103	93
16	136	124	111	93
20	139	128	115	98
30	145	134	122	106
40	149	139	128	112
70	157	148	139	126
100	162	155	147	135

**Gust speed in wind zone II**

Reference height in metres	TC I in kph	TC II in kph	TC III in kph	TC IV in kph
0	124	117	111	104
5	136	120	111	104
10	145	131	114	104
16	152	138	123	104
20	155	142	127	109
30	161	149	136	118
40	165	154	142	125
70	174	165	155	139
100	180	172	163	150

**Gust speed in wind zone III**

Reference height in metres	TC I in kph	TC II in kph	TC III in kph	TC IV in kph
0	137	129	122	114
5	149	132	122	114
10	159	144	126	114
16	167	152	135	114
20	170	156	140	119
30	177	164	149	129
40	182	170	156	137
70	192	181	170	153
100	198	189	180	165

**Gust speed in wind zone IV**

Reference height in metres	TC I in kph	TC II in kph	TC III in kph	TC IV in kph
0	149	140	133	124
5	163	144	133	124
10	174	157	137	124
16	182	166	148	125
20	186	170	153	130
30	193	179	163	141
40	198	185	170	150
70	209	198	185	167
100	216	206	196	180

**4th step: Determining what concrete blocks are required**

Based on the maximum gust speed, the number and size (10 or 16 kg) of concrete blocks required can be determined for the air-termination rod used. The value in the tables must lie above the maximum gust speed for the location.

**An example**

The maximum gust speed at the location is 142 km/h.

A tapered pipe air-termination rod of type 101 VL2500 and height 2.5 m is used.

Because the value in Table 2.15 must be higher than the maximum gust speed at the location (i.e. in this case more than 142 km/h), the next possible value is 164. Three concrete blocks, each of weight 16 kg, must therefore be used.

**Number of concrete blocks for tapered pipe air-termination rods**

Air-termination rod height in m	1.5	2	2.5	3	3.5	4	Concrete blocks required
Type	101 VL1500	101 VL2000	101 VL2500	101 VL3000	101 VL3500	101 VL4000	
Item no.	5401980	5401983	5401986	5401989	5401993	5401995	
Wind speed kph	117	-	-	-	-	-	1 x 10 kg
	164	120	95	-	-	-	2 x 10 kg
	165	122	96	-	-	-	1 x 16 kg
	-	170	135	111	95	-	2 x 16 kg
	-	208	164	136	116	102	3 x 16 kg

**Number of concrete blocks for air-termination rod, one end rounded**

Air-termination rod height in m	1	1.5	2	2.5	3	Concrete blocks required
Type	101 ALU-1000	101 ALU-1500	101 ALU-2000	101 ALU-2500	101 ALU-3000	
Item no.	5401771	5401801	5401836	5401852	5401879	
Wind speed kph	97	-	-	-	-	1 x 10 kg
	196	133	103	-	-	1 x 16 kg
	-	186	143	117	100	2 x 16 kg
	-	-	173	142	121	3 x 16 kg

**Number of concrete blocks for air-termination rod, one end rounded with connection strap**

Air-termination rod height in m	1	1.5	Concrete blocks required
Type	101 A-L 100	101 A-L 150	
Item no.	5401808	5401859	
Wind speed kph	100	-	1 x 10 kg
	192	129	1 x 16 kg
	-	177	2 x 16 kg
	-	214	3 x 16 kg

Table 2.15: Number of OBO concrete blocks required

**Wind loads and the isFang air-termination rod**

Table 2.16 shows the influence of wind zone, reference height and terrain category on the aluminium isFang air-termination rod (item no. 5402880) with isFang tripod stand (item no. 5408967).

In wind zone 1, with a reference height of up to 10 m, and at up to 800 m above sea level, for example, the number of concrete blocks can be reduced to just 6 (2 concrete blocks per bracket).

**Number of concrete blocks for isFang air-termination rods**

Wind zone	1			2		
	10	40	75	10	40	75
Reference height in metres						
Terrain category I	12	15	-	15	-	-
Terrain category II	9	15	15	12	-	-
Terrain category III	9	12	15	9	15	-
Terrain category IV	6	9	12	9	12	15

Table 2.16: Required number of OBO 16 kg concrete blocks in accordance with EN 1991-1-4 and EN 1991-3-1





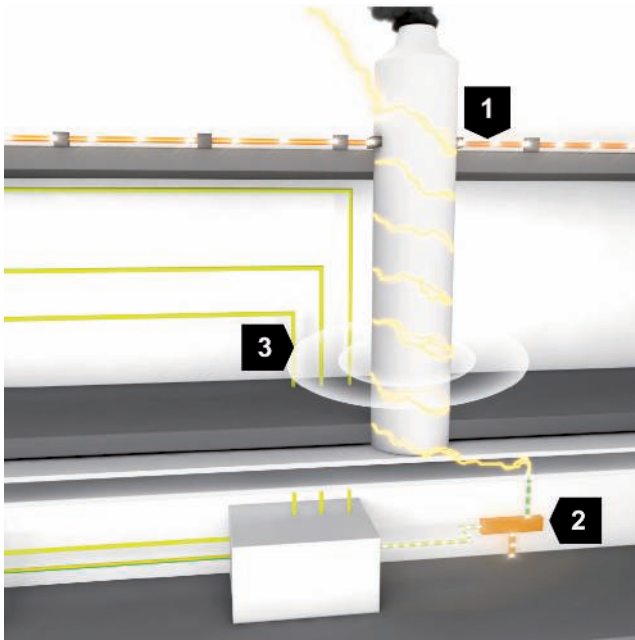

1	Lightning strike. The lightning current enters the building via metallic components
2	The equipotential busbar conducts the lightning current into the earthing system
3	Surge voltage in power and data cable due to electromagnetic coupling

*Danger due to non-isolated system*



*Isolated system with GRP holders*



*Insulated lightning protection with isFang*

### 2.1.7 Types of air-termination systems

Air-termination systems can be either isolated or non-isolated systems; the two types can be used in combination. Non-isolated systems are fitted directly to the object that is to be protected and the down-conductors are routed along the surface of the installation.

Isolated systems prevent direct strikes into the object/installation that is to be protected. This can be achieved with air-termination rods and masts, but also by fixing the components with insulating GRP (fiberglass-reinforced plastic) holders to the building/installation to be protected. In both cases it must be ensured that the separation distance (s) is adhered to. If this is not possible, the insulated, high-voltage-resistant isCon® conductor can be used to achieve an isolated air-termination system within a non-isolated system.

#### 2.1.7.1 Insulated, high-voltage-resistant air-termination systems

The OBO isFang modular air-termination rod system can offer a fast and freely terminable solution for insulated air-termination rods of up to 10 m high for the largest possible protection angle.

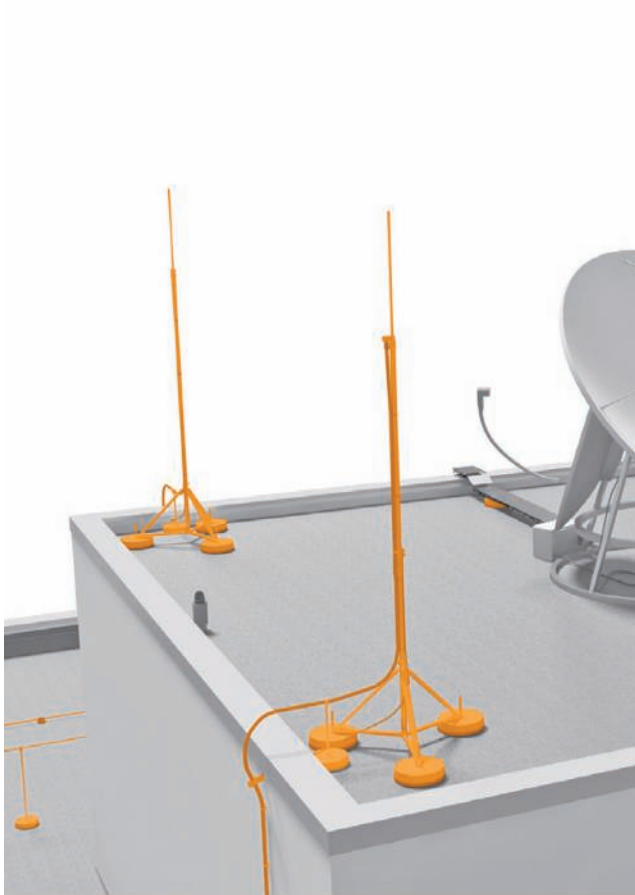

*Air-termination masts with external isCon®conductor*

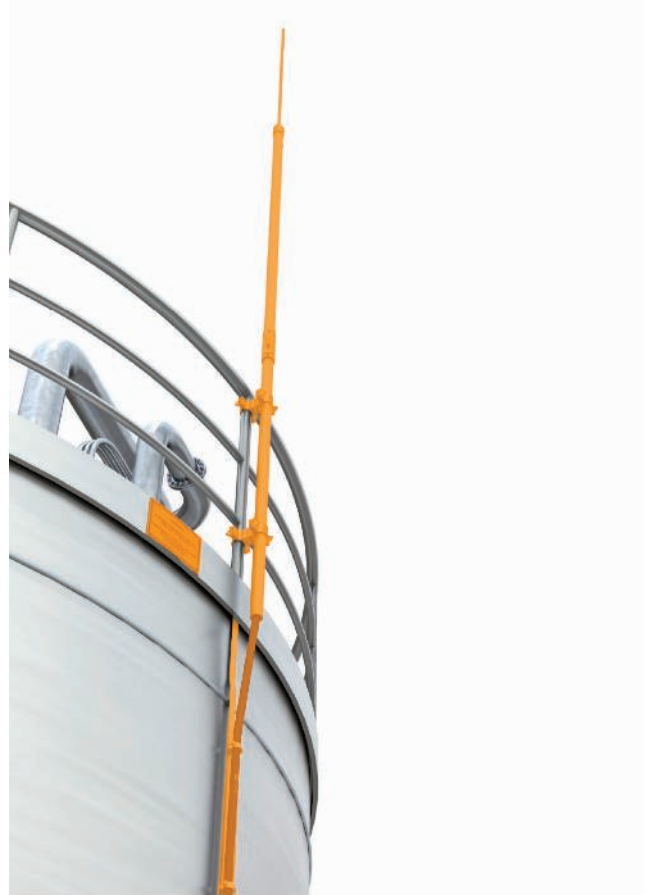

*Air-termination rod with internal isCon®conductor*

#### 2.1.7.1.1 Insulated air-termination masts with external isCon®conductor

The insulated air-termination masts protect electrical and metallic roof structures, taking the calculated separation distance (s) according to IEC 62305-3 into account. An insulated section of 1.5 metres made of fibre-glass-reinforced plastic (GRP) ensures sufficient distance to all roof structures. Even complex building structures can be protected by the comprehensive system accessories.

#### 2.1.7.1.2 Insulated air-termination rods with Internal isCon®conductor

The three-part aluminium and GRP air-termination rod with its insulated structure allows the isCon®conductor (black and light grey) to be routed inside the air-termination rod. Combining a perfect appearance with perfect functionality, it offers the following advantages:

- Tidy appearance through internal isCon®conductor
- 4 variants: 4 m to 10 m height
- Including connection element and potential connection in the rod
- For free-standing installation, can be combined with isFang air-termination rod stand with side exit

Visually attractive and functionally adapted insulated air-termination rod for flexible, simple and quick installation. The interior isCon® conductor means that the air-termination rod requires only a minimum wall attachment area and can thus also be installed at high and windy points.

Table 2.17 shows the required number of OBO 16 kg concrete blocks based on the maximum permissible gust speed and air-termination rod height. These values should be compared with those in Tables 2.11-2.14. If the value is smaller, then the number of concrete blocks should be adjusted accordingly.

The insulated air-termination rod should be connected to a reference potential using  $\geq 6 \text{ mm}^2$  Cu or an equal conductivity. Lightning current must not flow through the reference potential and it must be in the protective angle of the lightning protection system. This means that the potential connection can be made via metallic and earthed roof structures, generally earthed parts of the building structure and via the protective conductor of the low-voltage system.

#### Number of concrete blocks for insulated VA and AI air-termination rods

Air-termination rod height in m	4	6	4	6	Concrete blocks required
Material	VA	VA	AI	AI	
Item no.	5408942	5408946	5408943	5408947	
Item no. of appropriate air-termination rod stand	5408968	5408969	5408966	5408967	
Wind speed kph	120	94	120	92	3 x 16 kg
	161	122	163	122	6 x 16 kg
	194	145	197	147	9 x 16 kg
	222	165	227	168	12 x 16 kg
	246	182	252	187	15 x 16 kg

#### Number of concrete blocks for insulated air-termination rods with exit

Air-termination rod height in m	4	6	8	10	Concrete blocks required
Item no.	5408938	5408940	5408888	5408890	
Item no. of appropriate air-termination rod stand	5408930	5408932	5408902	5408902	
Wind speed kph	110	85	93	82	3 x 16 kg
	148	111	116	102	6 x 16 kg
	178	132	134	119	9 x 16 kg
	204	151	151	133	12 x 16 kg
	227	167	166	146	15 x 16 kg

2.17: Concrete blocks for insulated air-termination rods



Insulated air-termination system with separation distance (s)



Aluminium air-termination mast

### 2.1.7.2 Isolated air-termination systems

With the OBO isolated lightning protection, you can erect isolated air-termination systems safely, economically and in accordance with standards. The complex contours of metallic and electrical units protruding above the roof make particular demands on lightning protection and compliance with the separating distance.

#### 2.1.7.2.1 Aluminium air-termination rods

The 3-part air-termination rods of between 4 and 8 metres and made of aluminium complement the conventional air-termination system consisting of air-termination rod and concrete base, which is used for heights of up to 4 metres. Various brackets for mounting on walls, pipes and corner pipes, as well as two isFang tripod stands with different spreading widths, are available to fasten the various air-termination rods. The number of FangFix concrete bases required may vary according to the wind load zone (Table 2.19).

Number of concrete blocks for isFang air-termination rod with VA tripod stand

Air-termination rod height in m	4	4.5	5.0	5.5	6.0	6.5	7.0	7.5	8.0	Required concrete blocks
Air-termination rod item no.	5402 864	5402 866	5402 868	5402 870	5402 872	5402 874	5402 876	5402 878	5402 880	
Item no. of appropriate air-termination rod stand	5408 968	5408 968	5408 968	5408 968	5408 969	5408 969	5408 969	5408 969	5408 969	
Wind speed kph	143	124	110	99	104	96	89	83	78	<b>3 x 16 kg</b>
	193	168	148	133	138	127	117	109	102	<b>6 x 16 kg</b>
	232	202	178	159	165	151	139	129	121	<b>9 x 16 kg</b>
	266	231	203	182	188	172	159	147	138	<b>12 x 16 kg</b>
	296	257	226	202	208	191	176	163	152	<b>15 x 16 kg</b>

Table 2.18: Number of FangFix concrete blocks required

### Number of concrete blocks for isFang air-termination rod with tripod stand

Tele rod systems up to 19.5 m in height	4	4.5	5.0	5.5	6.0	6.5	7.0	7.5	8.0	Required concrete blocks
Air-termination rod item no.	5402 864	5402 866	5402 868	5402 870	5402 872	5402 874	5402 876	5402 878	5402 880	
Item no. of appropriate air-termination rod stand	5408 966	5408 966	5408 966	5408 966	5408 967	5408 967	5408 967	5408 967	5408 967	
Wind speed kph	140	122	108	97	101	93	86	80	76	<b>3 x 16 kg</b>
	191	166	146	131	136	124	115	107	100	<b>6 x 16 kg</b>
	230	200	176	158	163	149	138	128	120	<b>9 x 16 kg</b>
	264	229	202	181	186	170	157	146	136	<b>12 x 16 kg</b>
	295	255	225	201	206	189	174	162	151	<b>15 x 16 kg</b>

Table 2.19: Number of FangFix concrete blocks required

#### 2.1.7.2.2 Tele rod systems up to 19.5 m in height

They reach more than 19 metres high – the rod of the irod system by OBO. The flexible system protects extremely sensitive biogas plants as reliably as free-standing PV systems or installations in potentially explosive areas against direct lightning strikes.

The benefit of irod: There is no need for shovel or digger to move the earth and no concrete foundation needs to be poured. Solid concrete blocks, each weighing 16 kg, give both the air-termination rods and the stands sufficient support. During installation, it is very easy to align the systems using the threaded rods. Thanks to these features, irod is ideally suited for the installation in already existing systems.



Tele rods at biogas plant

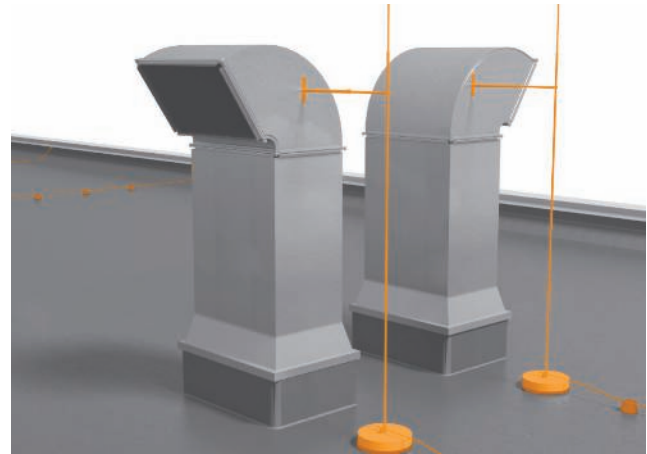

Air-termination rod with adjustable insulating beam

### 2.1.7.2.3 Systems with fibre-glass reinforced holders

The core of the system is an insulating, fibre-glass-reinforced plastic rod, which creates the separation distance safely and prevents uncontrolled arcing and dangerous spark creation. This means that no partial lightning currents can enter the building.

#### Two material thicknesses for different applications

The insulated lightning protection system consists of GRP rods with a diameter of 16 or 20 mm. Their properties are presented in Table 2.20.

### Particularly simple mounting through pre-terminated sets

Besides the modular products, we can offer you pre-installed sets for standard installation requirements:

- Set with two fastening plates
- Set with wall connection brackets
- Set for fastening on folds
- Set for fastening on pipes

16 mm GRP rods	20 mm GRP rods
0.75 - 1.5 and 3 m length	3 and 6 m length
UV-stable	UV-stable
Light grey	Light grey
Material factor $k_m$ : 0.7	Material factor $k_m$ : 0.7
Load torque: > 400 mm <sup>3</sup>	Load torque: > 750 mm <sup>3</sup>
Support load: 54 N (1.5 m)	Support load: 105 N (1.5 m)

Properties of the insulated GRP rods

*When calculating the separation distance, the material factor  $k_m = 0.7$  must be taken into account with GFK rods.*

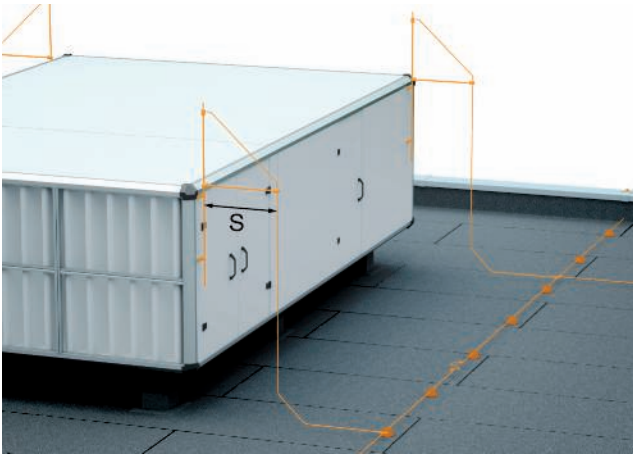

Example: air-termination system with Iso-combination set for triangular fastening

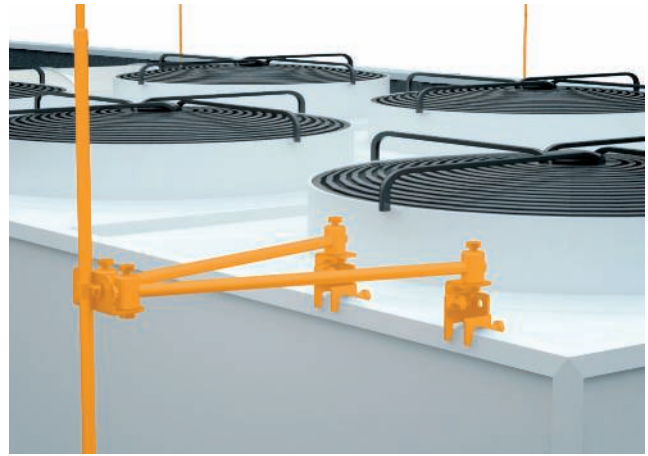

Example: air-termination system with Iso-combination set for fold fastening

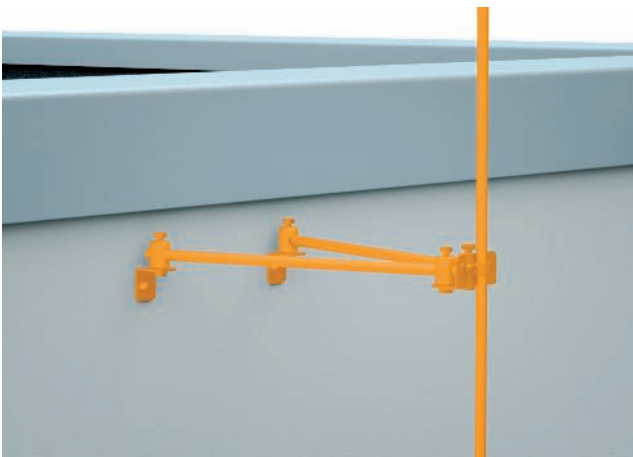

Example: air-termination system with Iso-combination set for V fastening

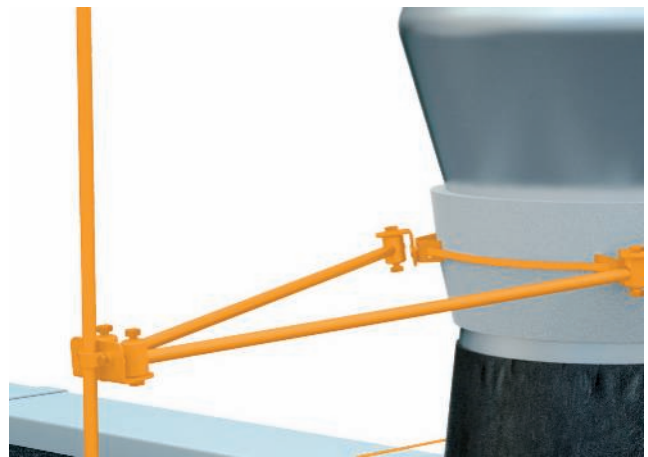

Example: air-termination system with Iso-combination set for pipe V fastening

### Triangular fastening

Iso-combination set (type 101 3-ES-16, item no.: 5408 97 6) for triangular connection for the erection of an insulated air-termination system at a safe separation distance (s).

### V fastening

Iso-combination set (type 101 VS-16, item no.: 5408 97 8) for wall fastening for the erection of an insulated air-termination system at a safe separation distance (s) of up to 750 mm. For mounting on walls and roof structures with two fastening plates. To accept air-termination rods and round conductors of 8, 16 and 20 mm diameter.

### Fold fastening

Iso-combination set (type 101 FS-16, item no.: 5408 98 0) for fold fastening for the erection of an insulated air-termination system at a safe separation distance (s). For mounting on the fold of supports and roof structures with folding clamps with a folding thickness of up to 20 mm. To accept air-termination rods and round conductors of 8, 16 and 20 mm diameter.

### Pipe V fastening

Iso-combination set (type 101 RVS-16, item no.: 5408 98 2) for pipe V fastening for the erection of an insulated air-termination system at a safe separation distance (s). For mounting on pipes with two pipe clamps. To accept air-termination rods and round conductors of 8, 16 and 20 mm diameter.

### 2.1.7.3 Installation principle, building with flat roof

In buildings with flat roofs, the grid solar is generally used. Roof structures such as PV systems, air-conditioning units, roof dome lights and ventilators are protected with additional air-termination rods.

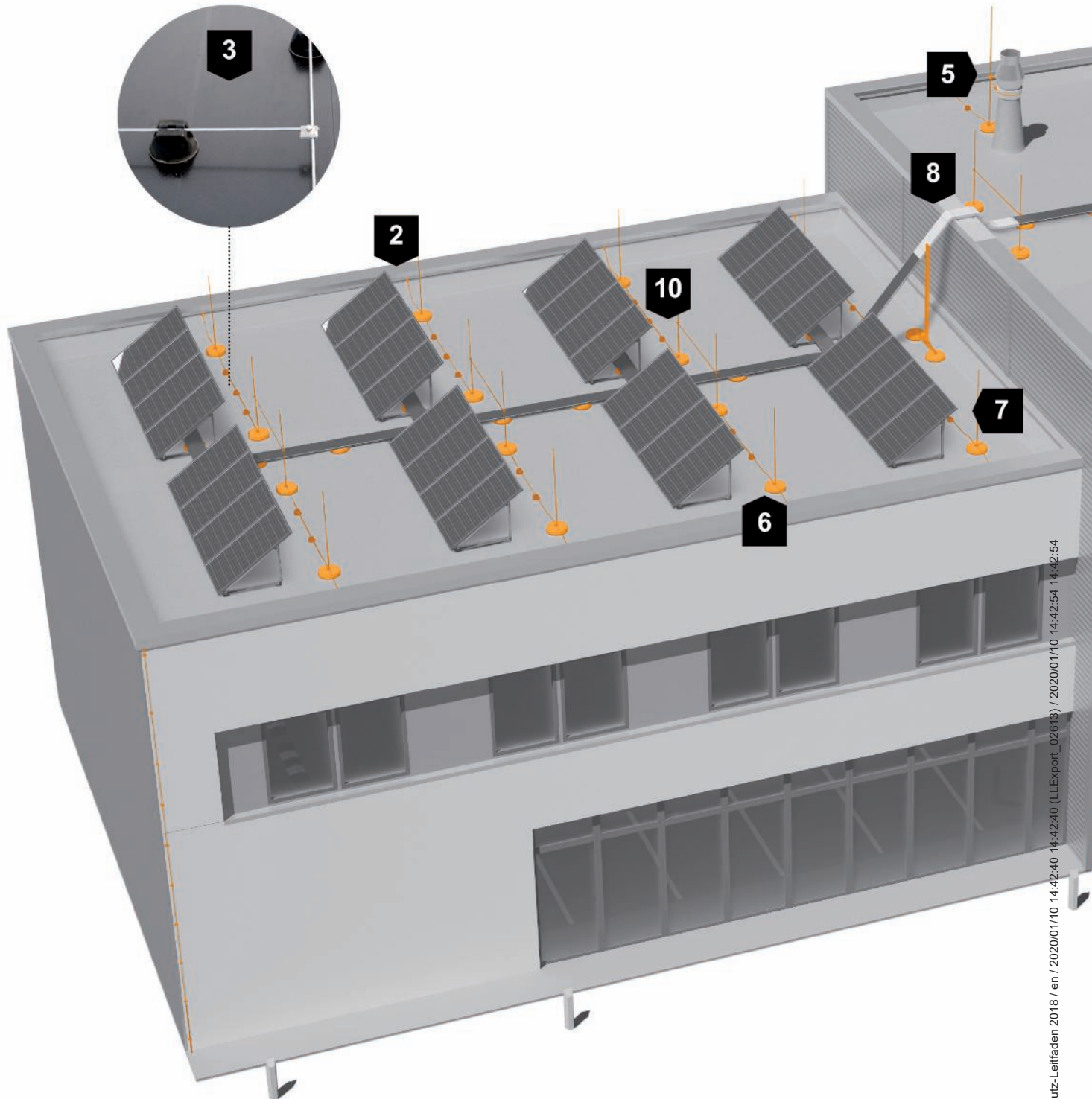

Example building with flat roof and lightning protection system



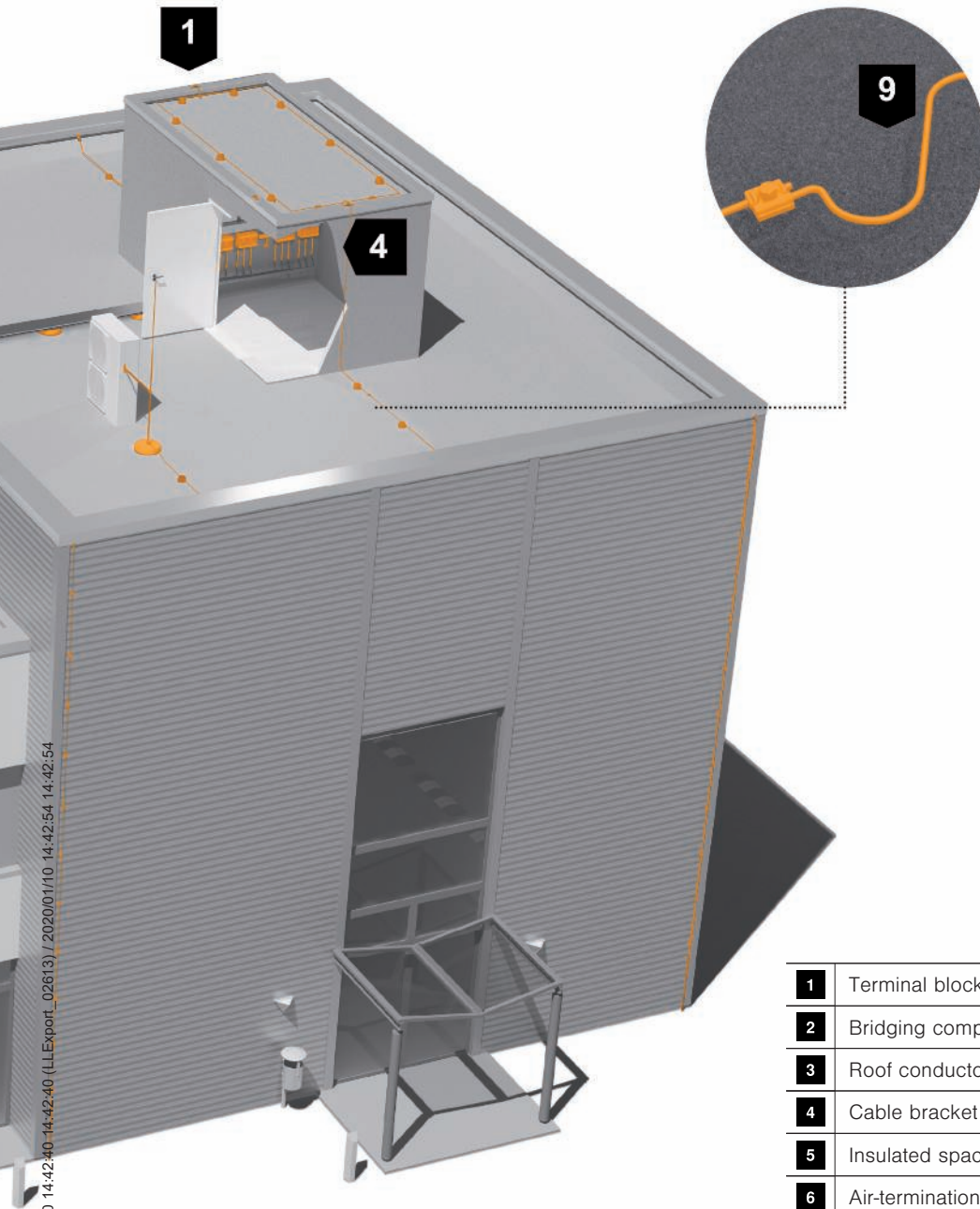

TBS Blitzschutz-Leitfaden 2018 / en / 2020/01/10 14:42:40 -14:42:40 (LLExport\_02613) / 2020/01/10 14:42:54 14:42:54

<b>1</b>	Terminal block
<b>2</b>	Bridging component
<b>3</b>	Roof conductor holder
<b>4</b>	Cable bracket
<b>5</b>	Insulated spacer
<b>6</b>	Air-termination system stand
<b>7</b>	Air-termination rod
<b>8</b>	Fire protection bandage over insulated parapet cover
<b>9</b>	Expansion piece
<b>10</b>	Vario quick connector

**1st step: Installing the air-termination system**

First, a round conductor is installed at all primary impact points such as ridges, crests or edges. Determine the protected area as follows: transfer the height of the building to the diagram and read off the protective angle. In our example, this angle is 62° with protection class III and a building height up to 10 m. Transfer the protective angle to the building. All building parts within this angle are protected.



<b>1</b>	Protected area
$\alpha$	Protective angle
a	Distance to furthest point of protected area
h	Height of the building

Installing the air-termination system

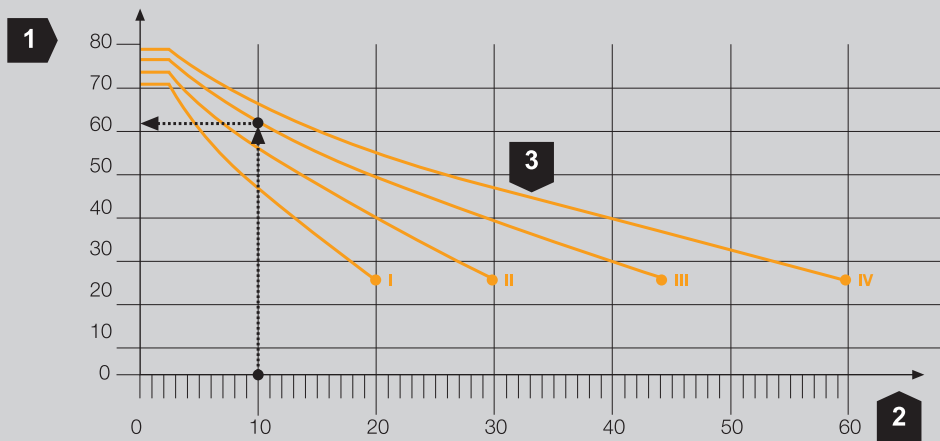

<b>1</b>	Lightning protective angle $\alpha$
<b>2</b>	Ridge height in m
<b>3</b>	Lightning protection classes I, II, III, IV

Diagram to assist in determining the protective angle in accordance with IEC 62305

**2nd step: Determine the protective angle**

**Example:**

The height of the building (in this case: 10 m) is entered onto the horizontal axis on the diagram (see point on axis "2" graph above). Then proceed vertically

until you meet the curve for your lightning protectio (in this case: III). You can now read the protective angle ( $\alpha$ ) off the vertical axis ("1"). In our example, the angle is 62°. Transfer the protective angle to the building. All building parts within this angle are protected.

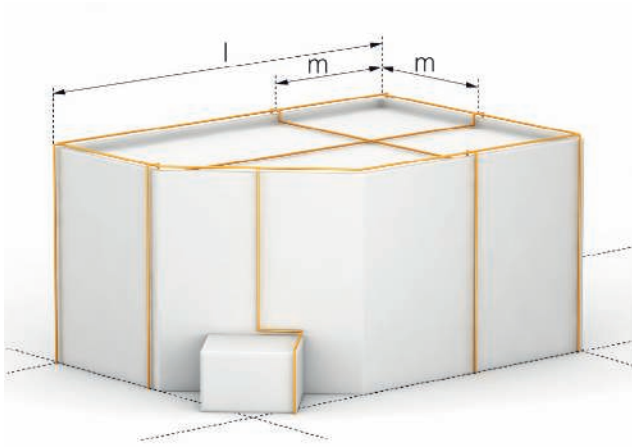

l	Length
m	Mesh width

Mesh width on a flat roof

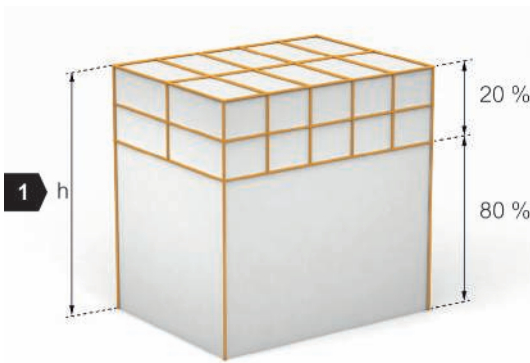

1	Building height (h) > 60m
---	---------------------------

Mesh method

Lightning protection class	Mesh width
I	5 x 5 m
II	10 x 10 m
III	15 x 15 m
IV	20 x 20 m

Table 2.21: Mesh width for different lightning protection classes

### 3rd step: Installing the mesh

A number of different grid sizes apply, depending on the lightning protection class of the building. The building in our example has building lightning protection class III. A mesh size of 15 m x 15 m must therefore not be exceeded. If, as in our example, the overall length  $l$  is greater than the cable lengths specified in Chapter 2 (grid method), an expansion piece must also be integrated for temperature-controlled length changes.

Up to now, roof cable holders for routing the grid have not been a part of the scope of application of the IEC 62561-4. However, DIN 18531-1 describes the requirements and basic planning and execution principles for sealing used and unused roofs. According to this, lightning protection components may not impair the sealing of the roof. All the lightning protection measures must be included in the roof sealing planning.

### 4th step: Protection against lateral impact

From a building height of 60 m and the risk of serious damage (e.g. with electrical or electronic devices) it is advisable to install a ring circuit to protect against lateral impact. The ring is installed in the top 20% of the building's height; the mesh size depends – as it does in the case of roof installation – on the lightning protection class, e.g. lightning protection class III corresponds to a loop size of 15 x 15 m.

The round conductors of the mesh are installed 1 m apart with roof cable holders. Where the material thickness and connections are sufficient, the metal of roof parapets is used as an air-termination system and mesh.

### 2.1.7.4 Installation principle for a building with a pitched/gabled roof

The exposed points, e.g. the ridge, chimneys and any roof structures, must be protected with air-termination systems.



Building with pitched roof and lightning protection system

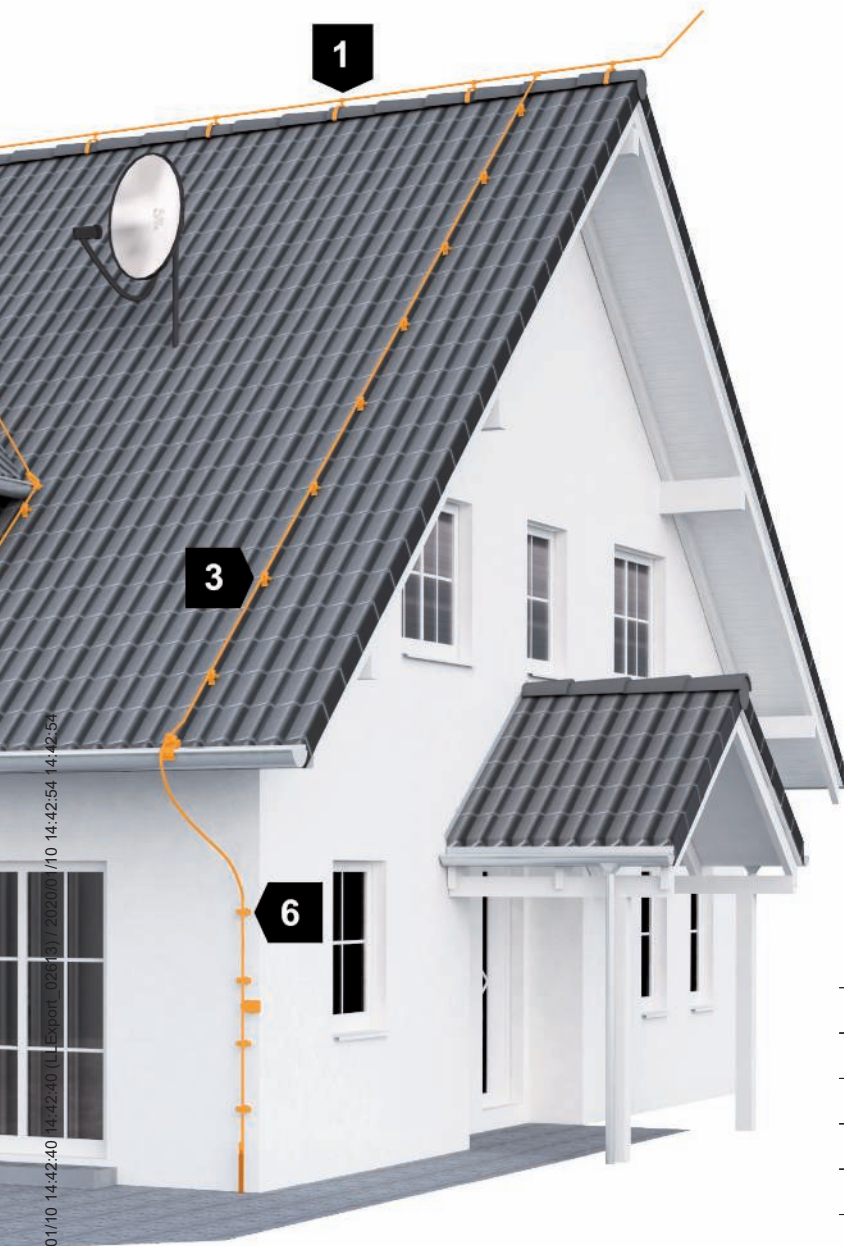

TBS Blitzschutz-Leitfaden 2018 / en / 2020/01/10 14:42:40 [L-Export\_022763] / 2020/01/10 14:42:54 14:42:54

<b>1</b>	Roof conductor holder for ridge tiles
<b>2</b>	Vario quick connector
<b>3</b>	Roof conductor holder
<b>4</b>	Round conductor
<b>5</b>	Air-termination rod
<b>6</b>	Cable bracket
<b>7</b>	Gutter clamp

**1st step: Determining the height of the building**

Determine the ridge height of the building. This height is the starting point for planning the entire lightning protection system. The ridge conductor is arranged on the ridge and thus forms the “backbone” for the air-termination system. In our example, the building is 10 m high. All parts of the building that do not fall under the protective angle are at risk from direct lightning strikes.

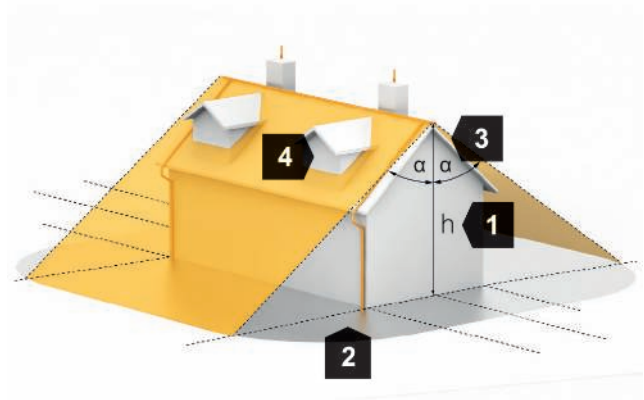

<b>1</b>	h: Building height
<b>2</b>	Protected area
<b>3</b>	Protective angle $\alpha$
<b>4</b>	Dormer windows not protected by the ridge cable

Protective angle method on roof ridge

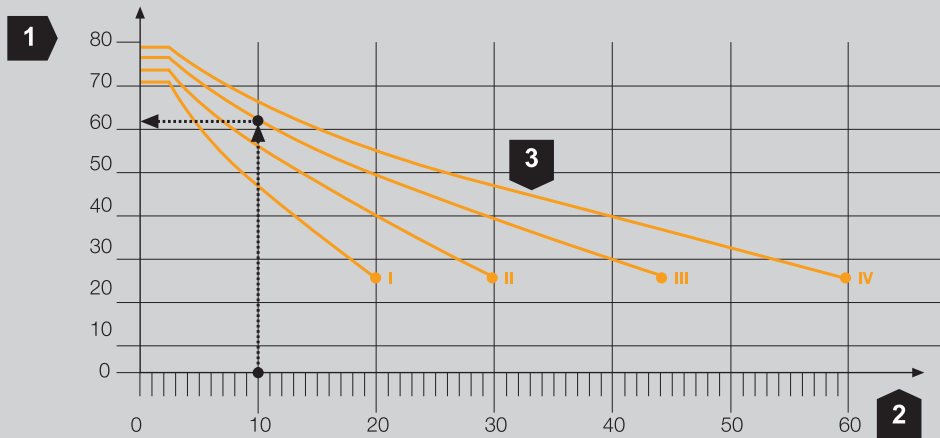

<b>1</b>	Lightning protective angle $\alpha$
<b>2</b>	Ridge height in m
<b>3</b>	Lightning protection classes I, II, III, IV

Diagram to assist in determining the protective angle

**2nd step: Determining the protective angle**

**Example:**

The height of the building (in this case: 10 m) is entered onto the horizontal axis on the diagram. Then proceed vertically until you meet the curve for your lightning protection class (in this case: III). You can now read the protective angle ( $\alpha$ ) off the vertical axis (“1”). In our example, the angle is  $62^\circ$ . Transfer the protective angle to the building. All building parts within this angle are protected.

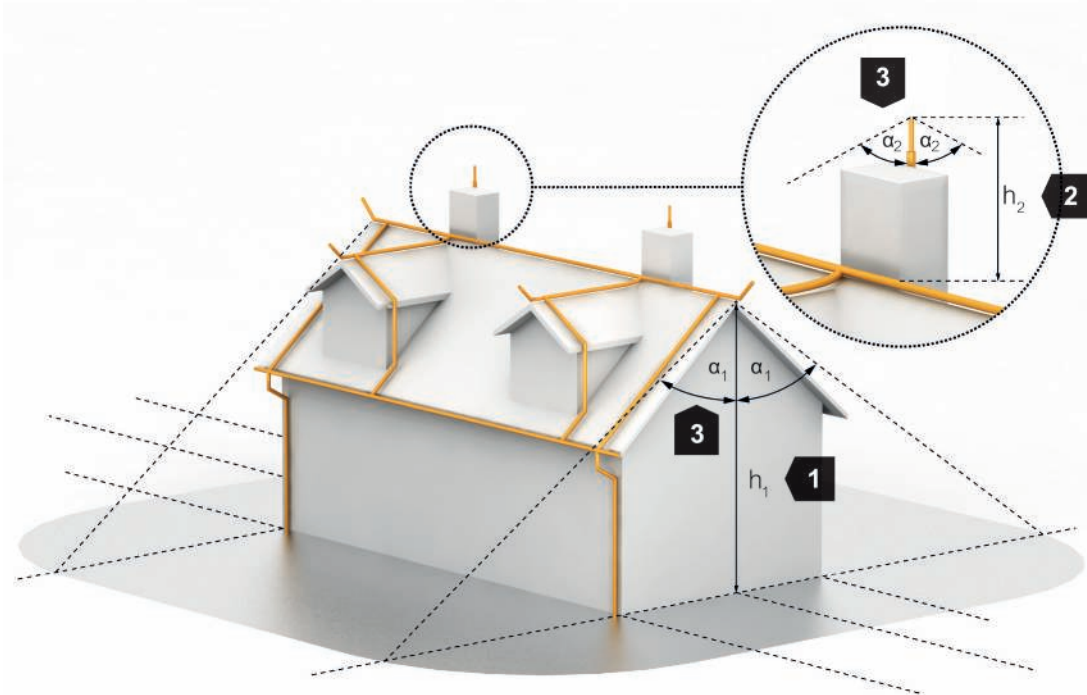

<b>1</b>	$h_1$ : building height
<b>2</b>	$h_2$ : air-termination rod height
<b>3</b>	Protective angle $\alpha$

Protective angle method for air termination rods

**3rd step: Building sections outside the protective angle**

Building parts outside of the protective angle require additional protection. The chimney in our example has a diameter of 70 cm and therefore requires a 1.50 m long air-termination rod. Always observe the protective angle. Dormer windows are given their own ridge conductor.

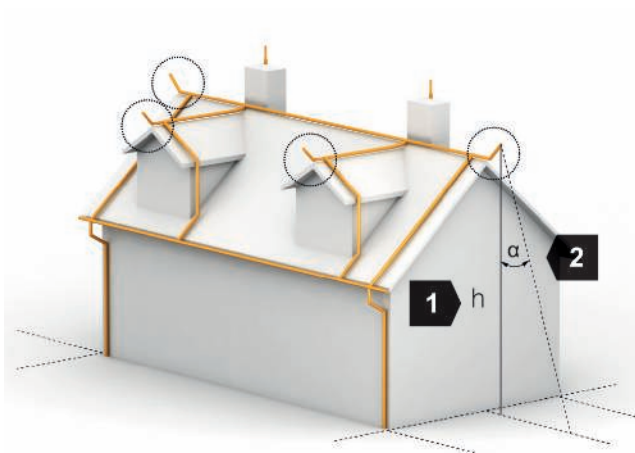

<b>1</b>	$h$ : Building height
<b>2</b>	Protective angle $\alpha$

Air termination systems and arrest down conductor system

**4th step: Completing the air-termination system**

Take the air-termination system down to the conductor equipment. The ends of the ridge conductor should protrude and curve upwards by 0.15 m. This also protects any projecting canopies.

The following roof structures must be protected with air-termination systems against direct lightning strikes:

- Metallic materials higher than 0.3 m
- Non-conductive materials (e.g. PVC pipes) with a height greater than 0.5 m

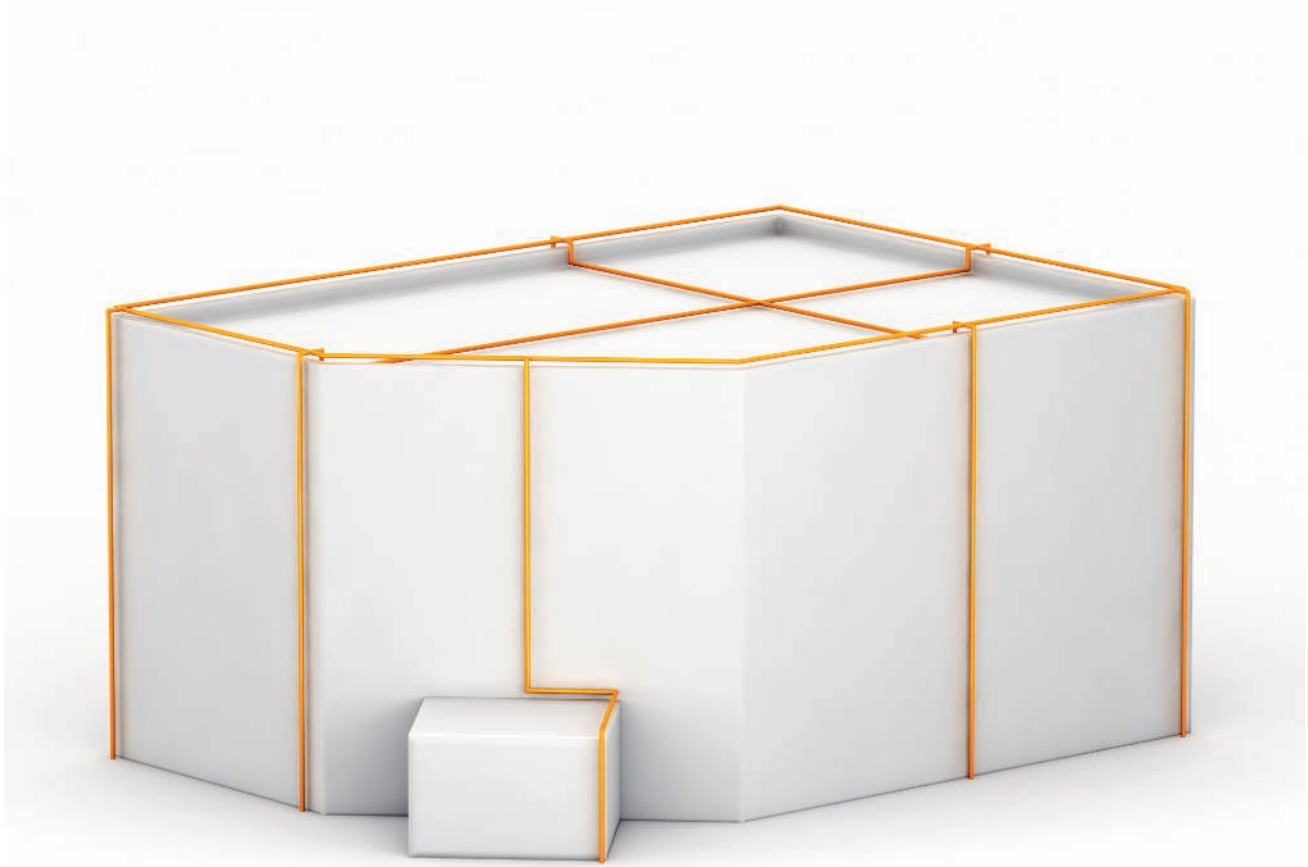

*Down-conductor system according to IEC 62305-3*

## 2.2 Down-conductors

Down-conductors are the part of the external lightning protection system designed to route the lightning current from the air-termination system to the earthing system. In order to reduce the probability of damage from the lightning current flowing through the lightning protection system, the down-conductors should be attached in such a way that, between the impact point and the earth:

- Multiple parallel current routes exist
- The length of the down-conductors is kept as short as possible
- Equipotential bonding is created between the conductive parts of the building structure.

The conductor system routes the lightning current from air-termination system to earthing system. The number of conductors is derived from the scope of the building to be protected, although at least two conductors are required in every case. Care must be taken to ensure that the current paths are short and installed without loops. Table 2.22 shows the distances between the conductors and the corresponding lightning protection classes.



## 2.2.1 Planning methods

The down-conductors connect the air-termination system with the earthing system via a short, direct connection.

### 2.2.1.1 Number and arrangement

The conductors should preferably be installed near the corners of the building. In order to achieve optimum splitting of the lightning current, the conductors must be evenly distributed around the outer walls of the building.

The reduction of the lightning current results in a smaller temperature rise of the metallic elements if there is a lightning strike. This means that it is possible to run the conductors behind heat insulation composite systems and fire locks, for example.

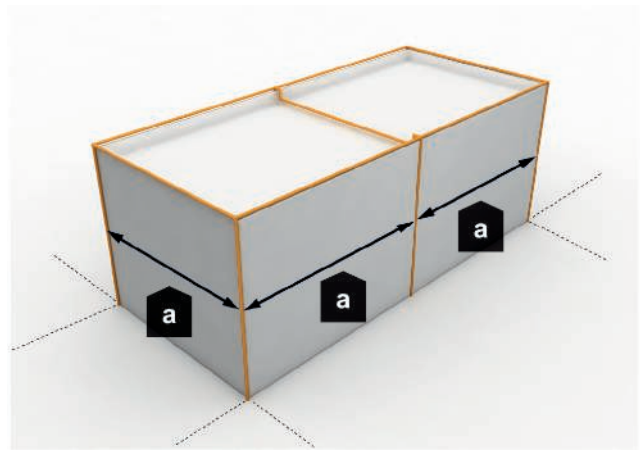

Distance (a) between the down-conductors

Lightning protection class	Distance between the down-conductors
I	10 m
II	10 m
III	15 m
IV	20 m

Table 2.22: Distances between down-conductors for different lightning protection classes

*A measuring point must be created at the point where each down conductor meets the earthing system. To enable easy identification, the measuring points should be marked, for example with numbers.*

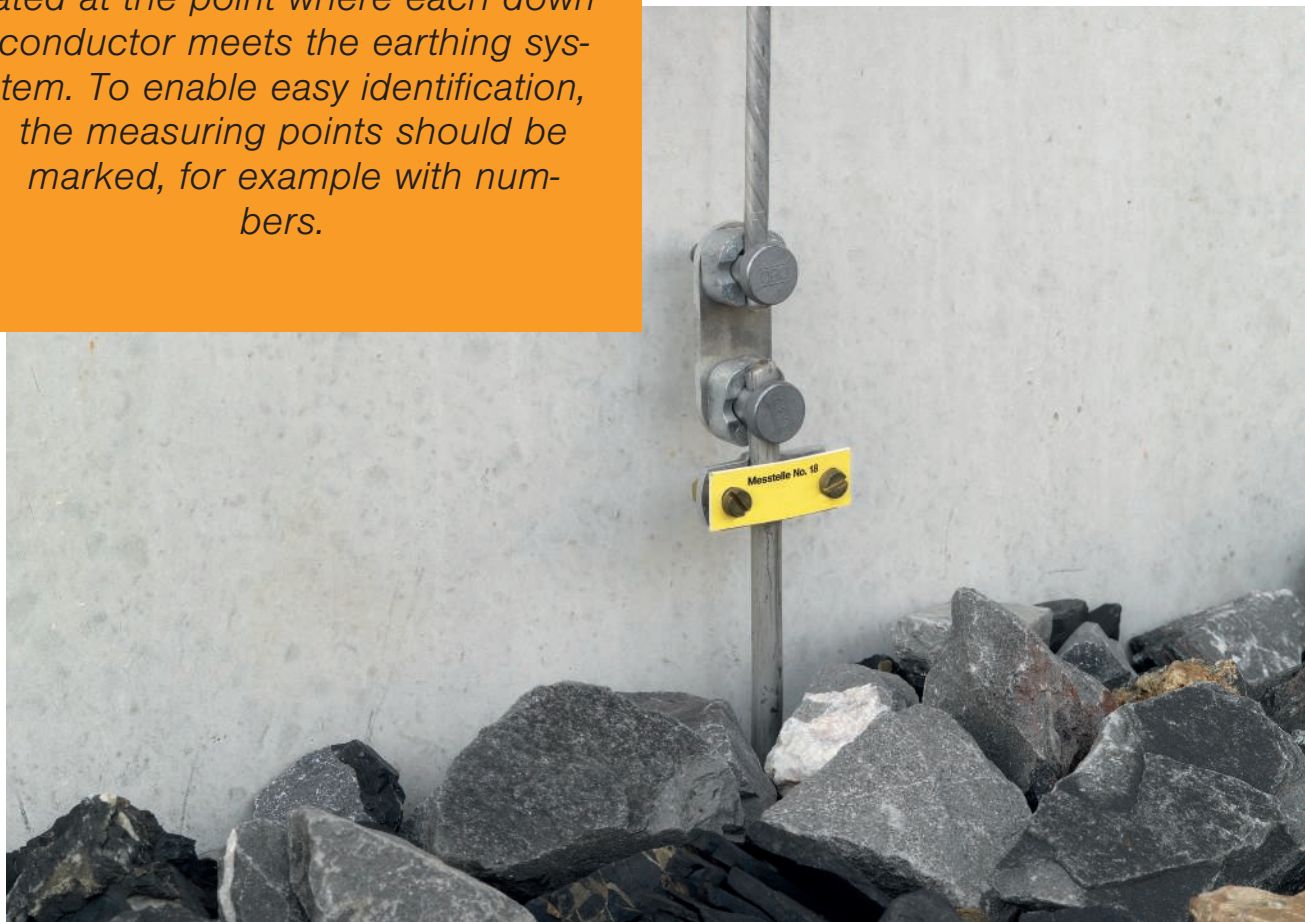

Measuring point at the point of entry into the earth



*Building with glass facade*

### **Down-conductors: special considerations**

If it is not possible to arrange down-conductors on one side or a side part of the building, then these down-conductors should be installed on the other sides. The distances between these down-conductors should not be smaller than 1/3 of the distances in Table 2.22.

### **General information: non-isolated downconductors/ connection of internal supports**

Building structures with a large area (such as typical industrial plants, trade fair halls, etc.) with dimensions larger than the quadruple down-conductor distance should be equipped with additional internal down-conductors with a spacing of 40 m, as far as is possible. All the internal supports and all internal partition walls with conductive parts, such as steel reinforcement rods, which do not fulfil the conditions for the separation distance, should be connected to the air-termination system and the earthing system at suitable points.

If, for architectural reasons, the down-conductors cannot be routed on the surface, then they should be installed in gaps in the masonry, for example.

The following should be noted in this regard:

- Plaster can be damaged by heat expansion.
- Plaster may be discoloured by chemical reactions.
- Conductors with PVC jacketing avoid such stains.

### **Fasteners**

Fasteners for conductors must be tested according to IEC 62561-4. The artificial aging of metallic fasteners is tested as is the artificial weathering of plastic holders, and mechanical load tests are also carried out.

Here, only the fastener is tested. Of equal importance is the correct mounting of the appropriate holder, with the matching mounting material for different wall and ceiling materials.

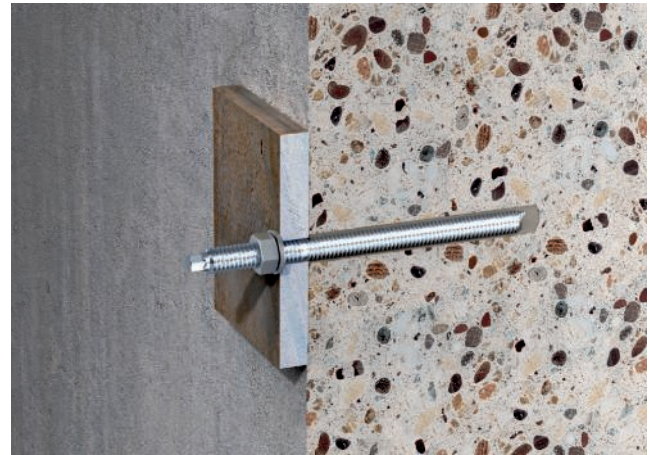
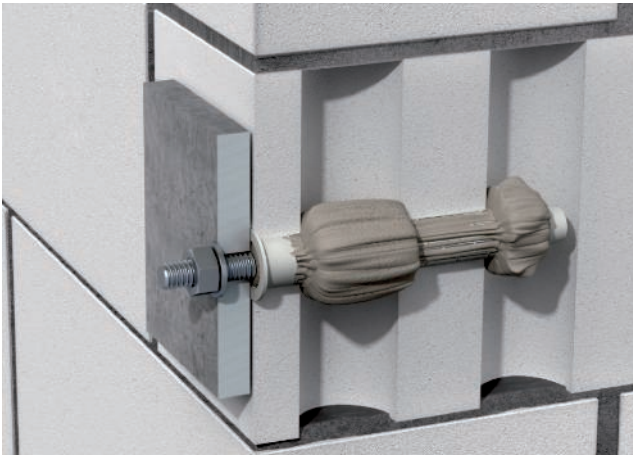

### 2.2.2 Fastening principles

There are three types of force transmission from the anchor to the substrate:

- Form fit
- Adhesive bond
- Friction bond

Anchors with form-fitting tap the substrate and support themselves on it. The anchor fits "tightly" into the component. Examples are back cut internal thread anchors or cavity ceiling ties. The threads of the bolt ties also work according to this principle.

Firmly bonded anchors join chemically to the substrate, e.g. through sticking with special mortar. Adhesive cartridges or injection systems, in which a threaded rod is mounted, are included in these fastenings. Cleaning the drill holes is very important for these systems, in order to prevent slipping out due to dust in the drill hole.

When a frictional connection is made, a spreading element set on the anchor body ensures locking in the drill hole. When mounted with the planned torque, the friction ensures the high load values.



### 2.2.3 Fastening substrates

The main differences are in the fastening substrates and load classes. While most anchors are suitable and approved for use in concrete, there are also special solutions for various masonry types, even for hollow brick or porous concrete. With metal spreading anchors, certain spacing distances must be guaranteed, e.g. to the edge of a component. As the metal spreading anchors develop lateral forces when subjected to loads, break-outs may occur when the prescribed spacing distances are not complied with. By contrast, bolt ties and injection systems can be placed very close to the edge, as they do not create any lateral forces.

For walls and ceilings in old, existing buildings, so-called extraction experiments are often required, in order to determine the resistance and load capacity of the construction.

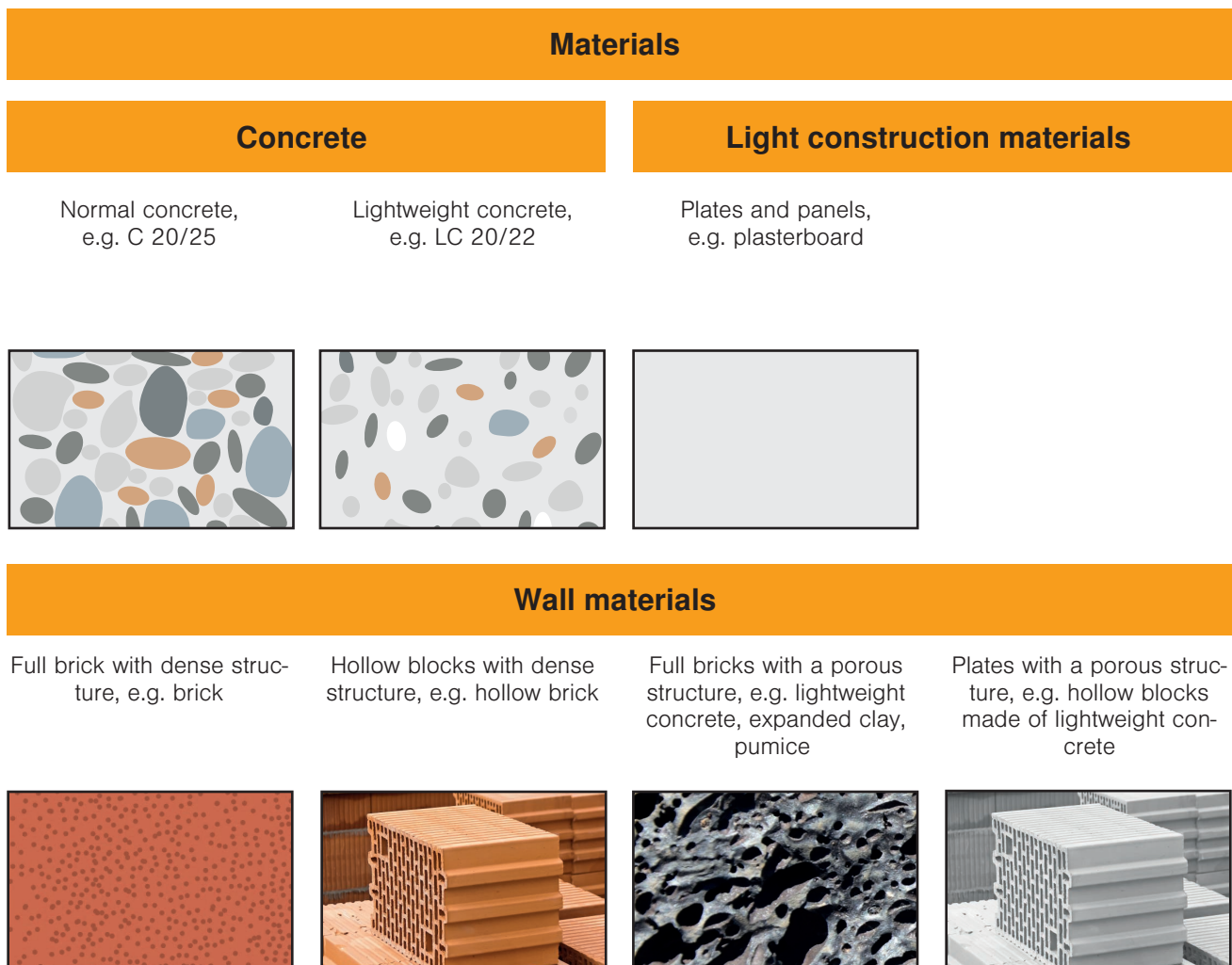

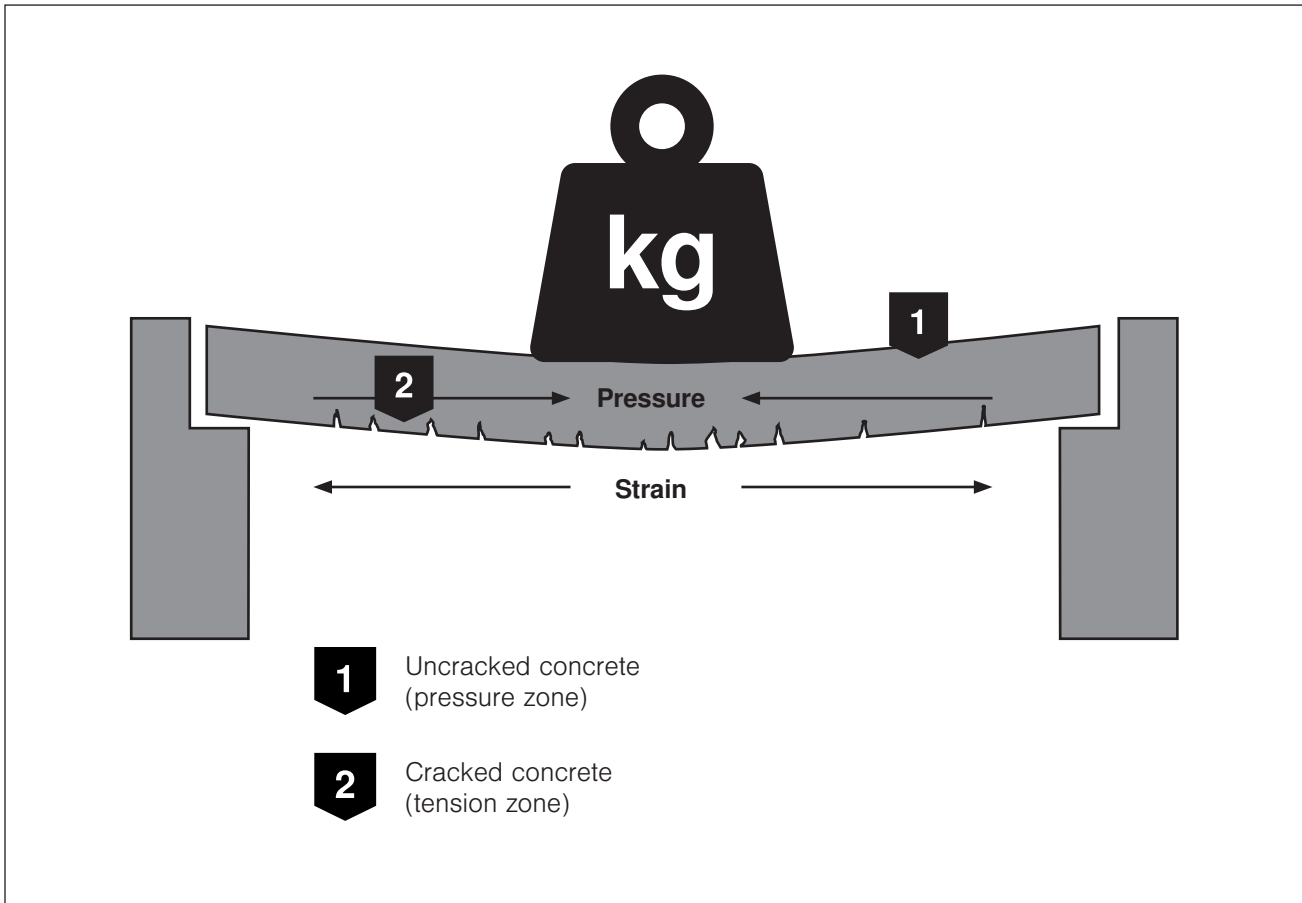

### 2.2.3.1 Concrete

One of the most frequently used construction materials is concrete. The load capacities are very high and thus ideally suited for the fastening of the technical building equipment. However, it is important to remember that ceilings experience so-called tension and pressure zones. Cracks can occur in the tension zone, which reduce the load capacity. With an unsuitable anchor, the fastened component can fall out of the drill hole. It must also be ensured that the anchors are suitable for cracked concrete and are approved.

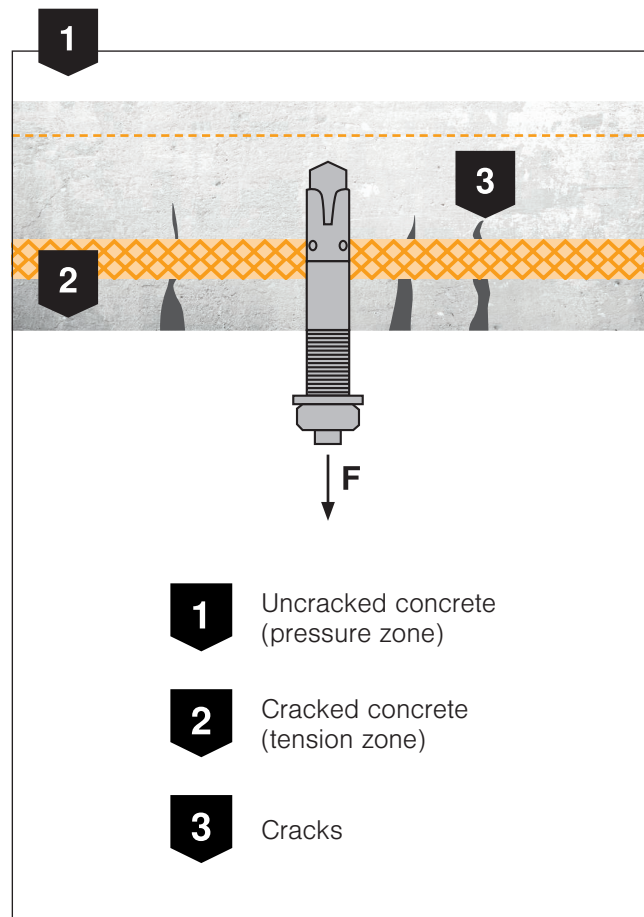

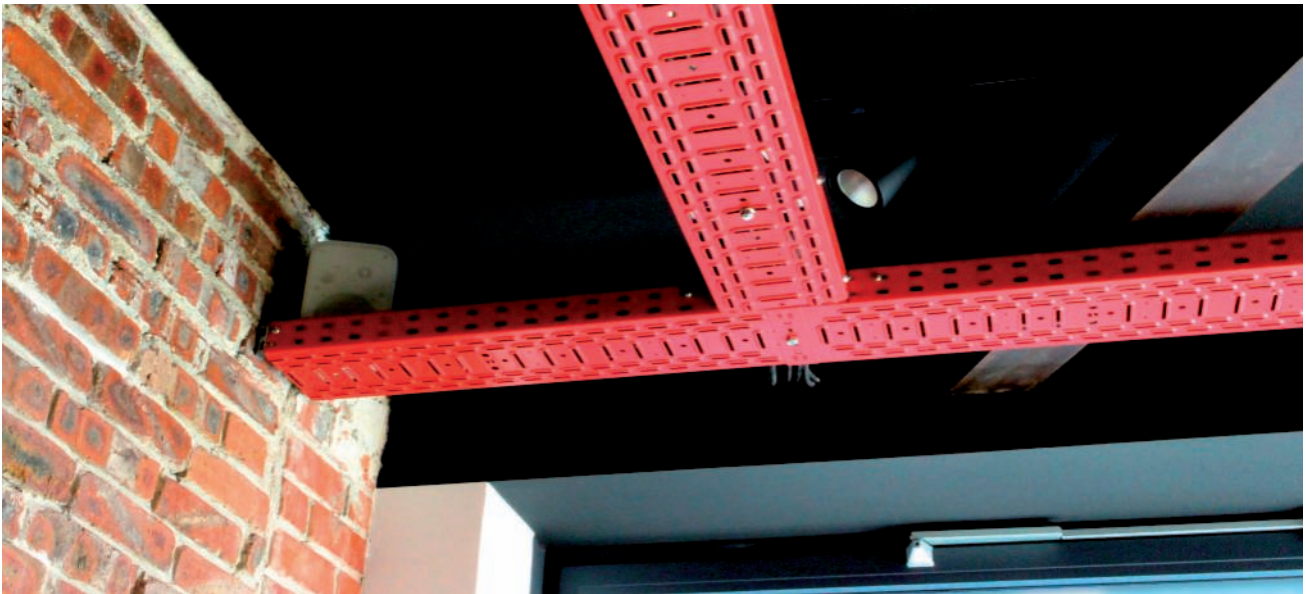

### 2.2.3.2 Masonry

Besides concrete, various masonry types of different stones play a special role in buildings. In order to fasten support systems or other loads on these walls, the stone types must have a minimum raw density and a minimum pressure resistance. If this data is not available, then withdrawal experiments may need to be performed, in order to determine the load capacity of the wall.

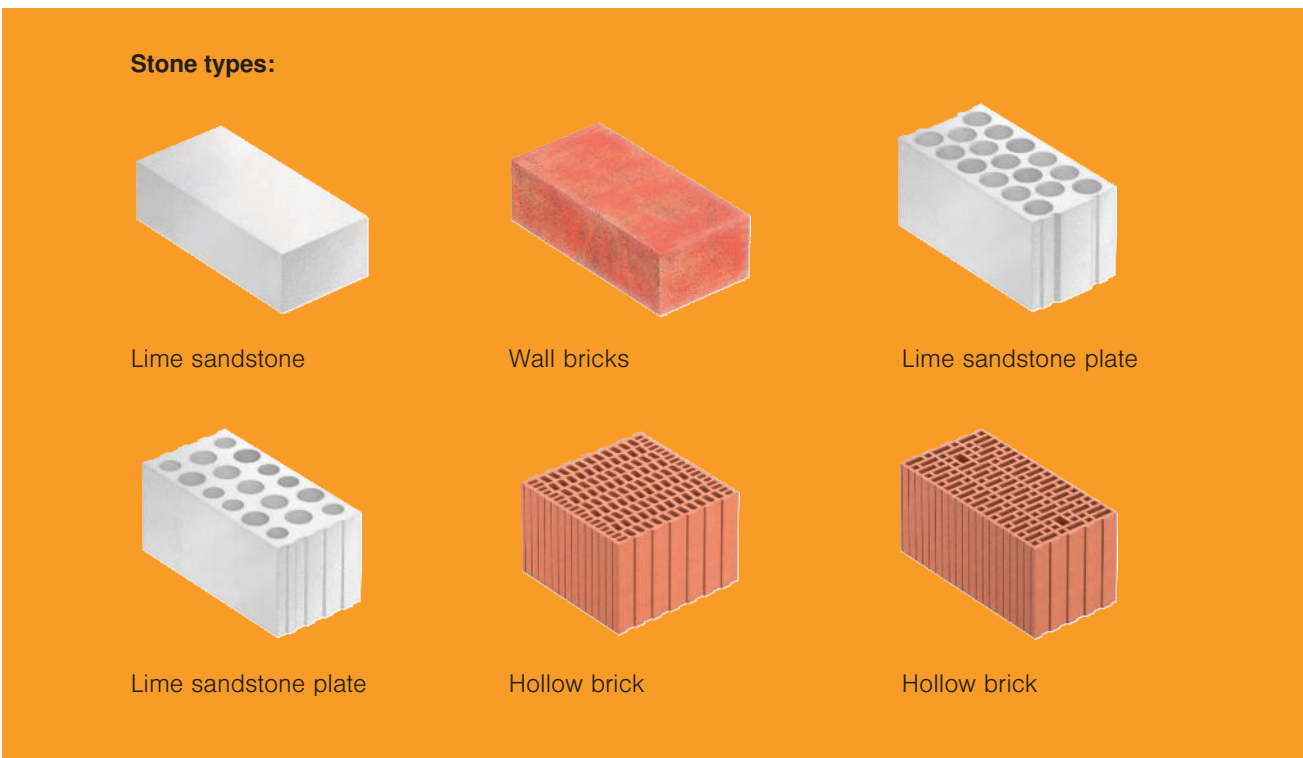

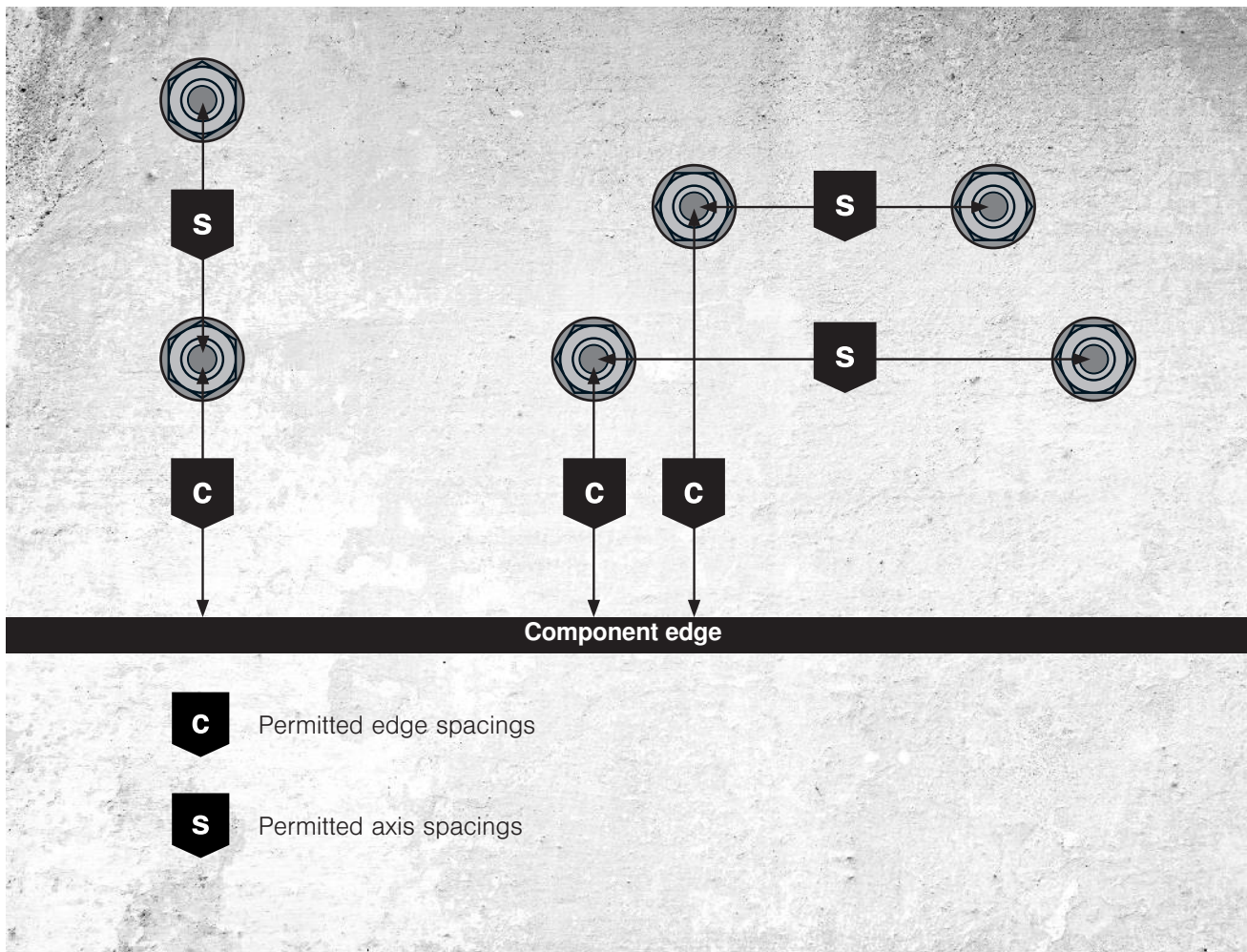

#### 2.2.4 Distances and setting depth

Edge and axis distances play a major role when setting anchors. This means the distances to component edges and distances from anchor to anchor. If these are not maintained, then the load values are reduced and failure of the fastening is more likely. Of course, the setting depth is the main criterion for the maximum load values. The deeper an anchor can be anchored in the substrate, the greater the load to be fastened to it can be.

*Deeper anchoring = greater concrete load capacity*

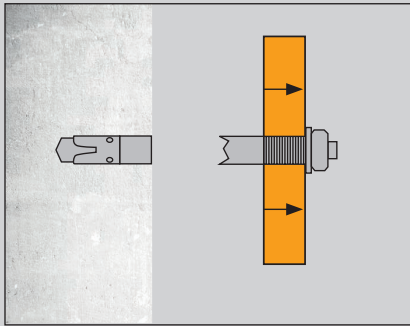

Steel break

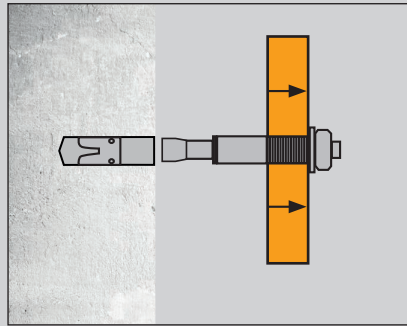

Pull-through

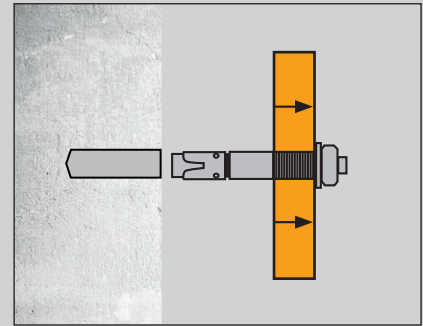

Pulling out

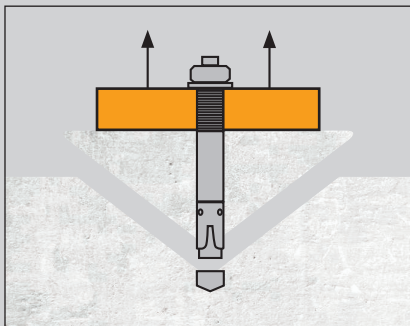

Concrete break-out



Columns

### 2.2.5 Failure criteria

Different failure criteria occur depending on the mounting arrangement and load of the anchors. Under a tensile load, these are:

- Steel break
- Pulling out
- Pull-through
- Concrete break-out
- Columns

The following reasons for failure occur with transverse loads:

- Steel break through shearing
- Concrete edge break
- Concrete break-out on the side away from the load

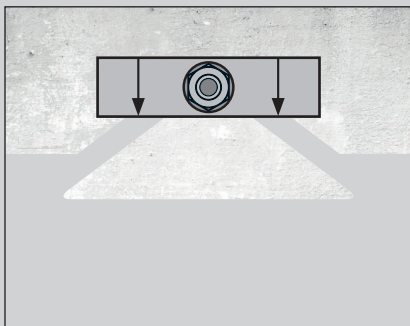

Concrete edge break

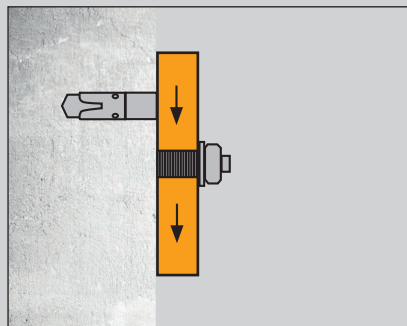

Steel break

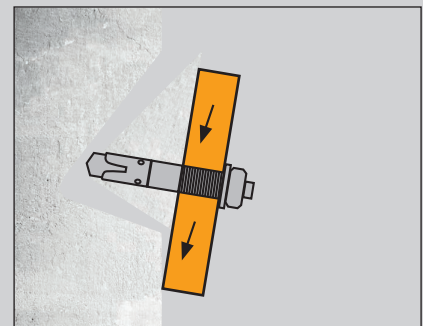

Concrete break-out on the side away from the load



**Selection aid**

To determine suitable anchors, basic parameters must first be queried:

- Fastening substrate
- Application area
- Load
- Mounting type

All the data relevant to the mounting of anchors and bolt ties for the fastening of fireproof installations must be contained in the approval documents.

**2.2.6 Types of anchors**

Besides all the already described parameters, the means of fastening must also be suitable for the ambient atmosphere in which they are used. Many materials and surfaces are available, from electrogalvanised anchors and bolt ties up to highly corrosion-resistant steels.

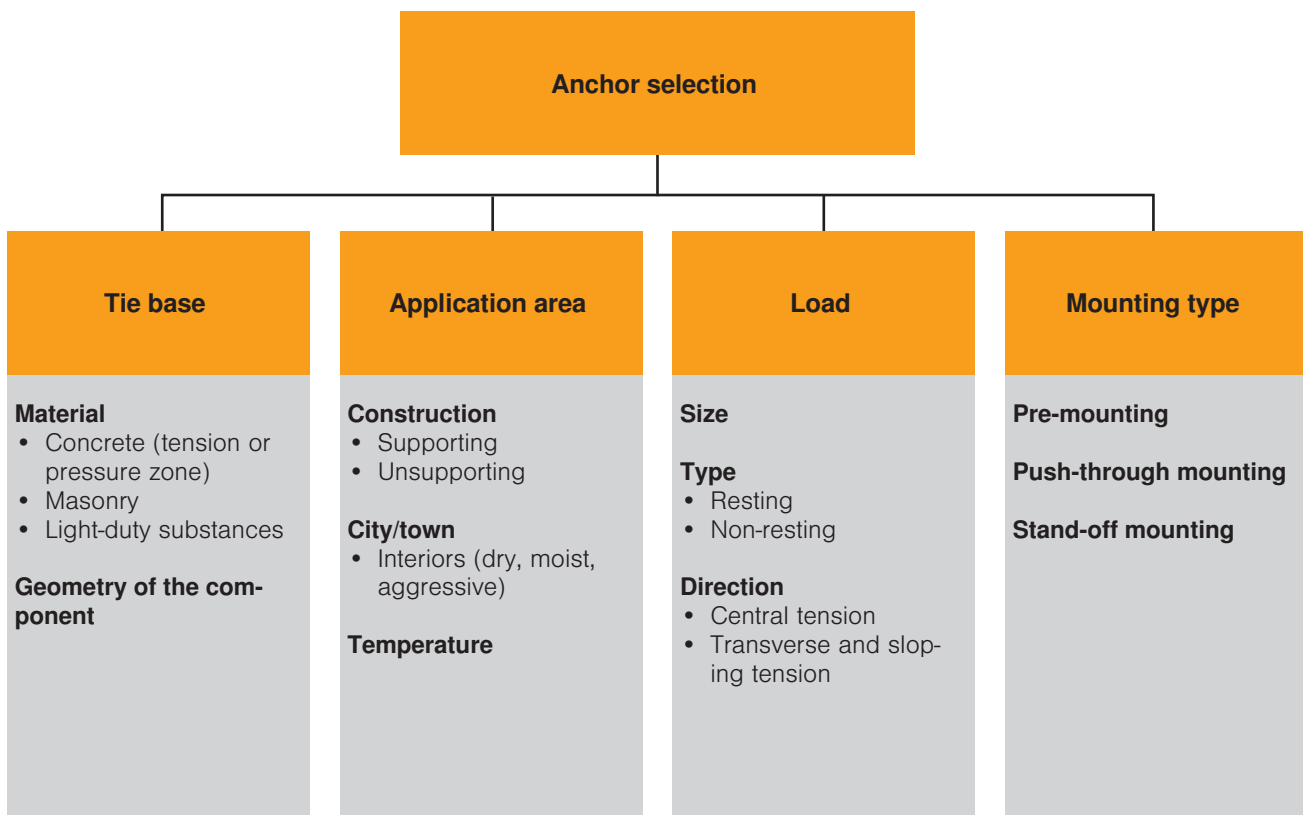



### Metal spreading anchor

OBO Bettermann's metal spreading anchors for mounting on concrete were tested for fire protection. Appropriate proofs are available for the tests carried out. Depending on the fire resistance length (up to 120 minutes), a maximum load capacity was determined when anchored in concrete. This load data is contained in the appropriate European technical ap-

provals and appropriate test documentation. Although the load capacity of the anchors during a fire is below the load capacity when cold, this load capacity is completely sufficient for fireproof fastening of the different routing types. Special metal spreading anchors are offered for false ceilings.

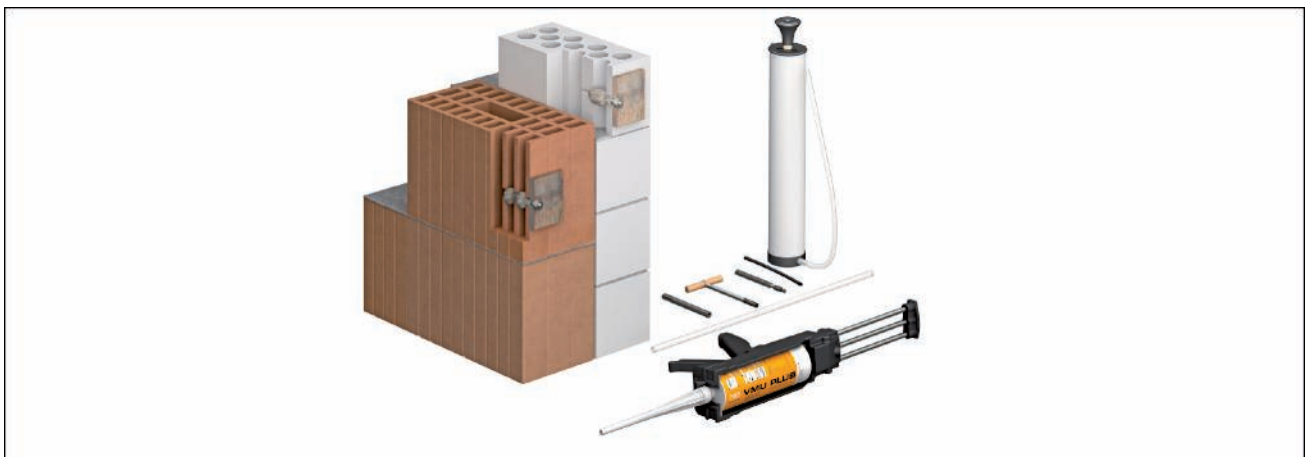

### Injection mortar

The VMS Plus injection mortar system is particularly suitable for fastening in hollow brick, concrete and porous concrete, calcareous limestone, sand-lime brick and masonry. The connection is free from spreading pressure and is created through the form fitting of the injection mortar with the substrate and an anchor rod. The components are tested and approved for a fire resistance period of 90 minutes. The maxim-

um load capacity depending on the fire resistance period and the fastening substrate is documented accordingly in the available fire protection certificate. Although the load capacity of the injection mortar system is below the load capacity when cold, this load capacity is completely sufficient for fireproof fastening of the different routing types.



### Bolt ties

OBO Bettermann's fire protection bolt ties were fire-tested according to ETAG 001 Part 3. The maximum load capacity, depending on fire resistance periods of up to 120 minutes, was determined for different types of solid masonry. These values are documented in the appropriate test certificates. Taking the occurring loads for the maintenance of electrical functionality applications and for false ceiling mounting into ac-

count, the determined load capacities for the different masonry types are absolutely sufficient. The fire protection bolt ties are screwed directly into the drill hole. There is no need for an additional anchor. No spreading forces develop and mounting near masonry edges is not required. The bolt tie is equally suitable for cracked concrete in ceilings.

Construction requirements	Additional requirement No smoke	Additional requirement No falling or dripping of burning material	European classes accord- ing to DIN EN 13501-1	Class according to DIN 4102-1
Non-combustible	X	X	A1	A1 A2
- Minimum	X	X	A2 - s1 d0	A1 A2
Hardly flammable	X	X	B, C - s1 d0	B1
Hardly flammable		X	A2 - s2 d0 A2, B, C - s3 d0	B1
Hardly flammable	X		A2 - s1 d1 A2, B, C - s1 d2	B1
- Minimum			A2, B, C - s3 d2	B1
Normally flammable		X	D - s1 d0 - s2 d0 - s3 d0 E	B2
- Minimum			E - d2	B2
Easily flammable			F	B3

Table: Construction material classes according to EN 13501-1



### 2.2.7 Fastening on steel structures

In industrial construction, steel constructions are frequently used for the building structures. Steel girders and supports can also be found in power stations. However, at approx. 500 °C, steel loses half of its resistance, so that, if there is a fire, the building structures are exposed to a high risk. Thus, unprotected steel does not possess fire resistance, meaning that special measures are necessary, such as treatment with fire protection coatings or lining with non-combustible plates.

At first, fastening of support systems to steel girders seems barely possible. However, if the supporting steel elements of the building are unprotected, other technical equipment, e.g. smoke extraction or automatic extinguishing systems, can compensate for the bad properties of the steel in case of fire by limiting the critical temperatures.

As steel girders may usually not be drilled through, the only other option is fastening with construction clamps. If steel girders are used as a natural conductor, or if they are to be connected to the earthing system, then construction clamps able to carry lightning current must be used.

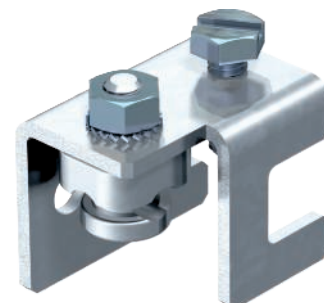

*Construction clamp, type 5010, able to carry lightning current*



### 2.2.8 Fastening on wooden components

In future, ever more buildings will be erected with wooden support structures. With suitable fire protection measures, these buildings do not present a greater risk during a fire than buildings erected conventionally. In addition, hall structures with large span widths using glue binders are possible. And wood is also becoming ever more popular as a sustainable resource and, for environmental reasons, is increasingly used in construction (structural engineering).

Wood is a combustible material and, as with steel constructions, wooden components are firstly only suitable under certain conditions for the fastening of

fire-tested electrical installations. Coatings and paneling are also used in the constructions, in order to achieve a fire resistance class at all. However, if there is a fire, wood has a very good property: When burning, an insulated layer is created which delays further combustion. The wooden component must be dimensioned in such a way that failure of the carrying capacity cannot occur at an early stage. The combustion rates are a standard means for calculating the required wooden cross-section, depending on the desired fire resistance class. The combustion rates depend on the type of wood and the moisture content of the wood.



Wood screws with a suitable steel cross-section and sufficient setting depth are used, taking burning rates into account. The long screws drill deep into the cross-section of the wooden beam, ensuring a secure hold of the mounted support systems, despite burning. Various mounting variants are documented in a fire protection survey.

Wood type	Structure	Characteristic density [kg/m <sup>3</sup> ]	Burn rate [mm/min]
Pine and beech	Laminated timber	≥ 290	0.70
	Solid wood	≥ 290	0.80
Hardwood	Solid wood or laminated timber	≥ 290	0.70
		≥ 450	0.55
Veneer timber		≥ 480	0.70
Plates (min. 20 mm)	Wood panelling	≥ 450	0.90
	Plywood	≥ 450	1.00
	Wooden panels made of plywood	≥ 450	0.90

*Burn rates of various wooden components*

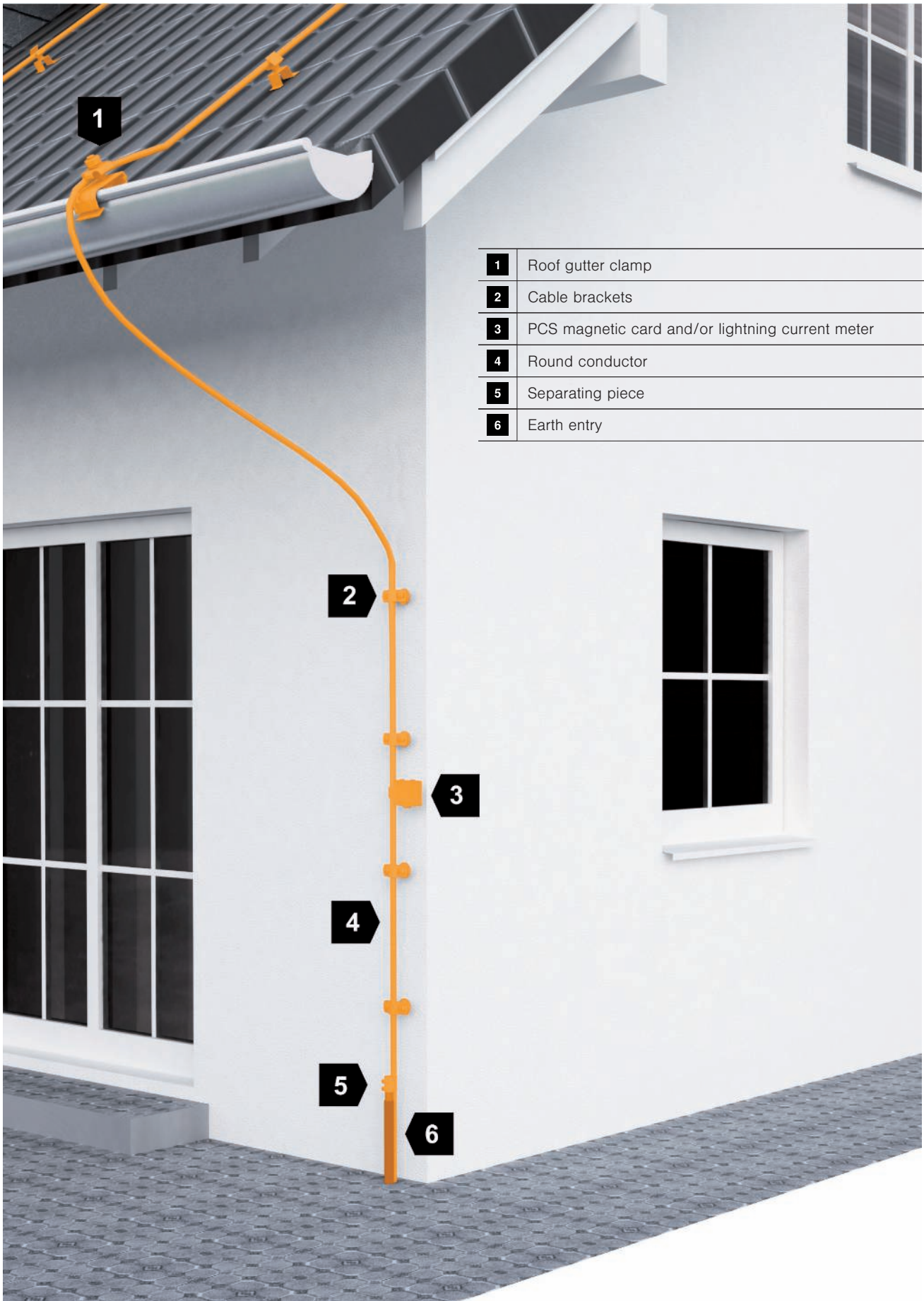

<b>1</b>	Roof gutter clamp
<b>2</b>	Cable brackets
<b>3</b>	PCS magnetic card and/or lightning current meter
<b>4</b>	Round conductor
<b>5</b>	Separating piece
<b>6</b>	Earth entry

Installation principle, down-conductor unit

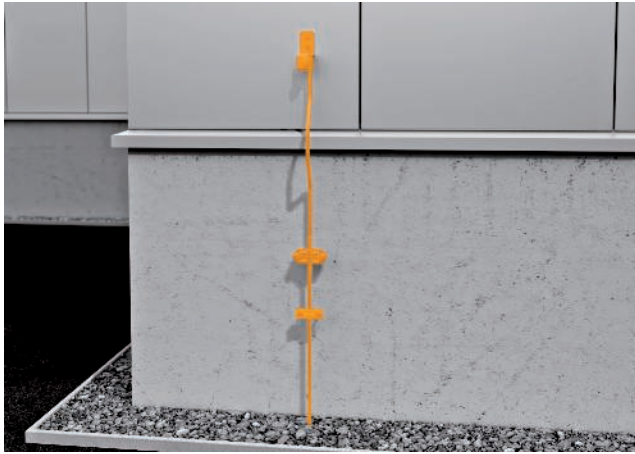

Example: vertical facade elements

*When natural conductors (e.g. reinforced concrete or steel supports) are used, it is often not possible to isolate the lightning protection system and earthing system.*

### 2.2.9 Use of natural components

**Metallic installations can be used as natural components of a conductor system, provided that:**

- Electrical continuity is permanent,
- Their dimensions correspond at least to the values for standardised conductors (Table 2.6).

Pipelines with combustible or explosive contents are not permitted, if the seals in flange couplings are not connected so that they are electrically conductive.

#### **Precondition for facade elements and metallic constructions:**

- Their dimensions must correspond to the requirements for down-conductors and the thickness of the metal plates/pipes must be at least 0.5 mm.
- Their electrical continuity in the vertical direction must meet the requirements.
- Facade elements can also be used as down-conductors systems, provided that they are electrically interconnected.
- Natural elements for down-conductors systems must be executed according to IEC 62365-3.

**Electrically connected reinforced concrete (metal reinforcement) can be used as a natural component of a conductor system if:**

- Connection points are provided in a reinforced concrete part,
- the prefabricated concrete parts are interconnected during mounting on the construction site.
- In stressed concrete, the risk of impermissible mechanical influences due to exposure to lightning current is taken into account.



Example: use of horizontally connected facade elements as an down-conductor system

*Metallic installations may be surrounded with insulating material, e.g. a painted layer.*





Example: use of reinforced concrete supports/ down-conductor system

In building structures with reinforced concrete supports or walls, the down-conductors must be routed in the reinforcement. The down-conductors must be routed in sections. This requires exact coordination. The connection points must be created carefully with clamp connectors. The down-conductors must also be additionally connected to the reinforcement.

Reinforced concrete elements are ideally suited as a down-conductors system, provided that this use is included in the planning process in good time. Exact specifications are required for the manufacture of the reinforced concrete elements. Production must be checked and documented in photographs. Earthing fixed points should be used as connection points for down-conductors and the equipotential bonding.

#### Continuous reinforcement of the building structure

If the reinforcement or reinforced concrete in the building structure is being used as a natural down-conductor, it must be joined to the air termination system using lightning protection connection components in accordance with IEC 62561-1 (DIN EN 62561-1). A connection to the earthing system capable of withstanding lightning current must also be executed, at least to the main earthing rail. If the natural down-conductor is also to be optimised as protection against LEMP (lightning electromagnetic impulse), corresponding grids within the system should be realised. Here grid widths of  $a = 5$  m and  $b = 1$  m are recommended.

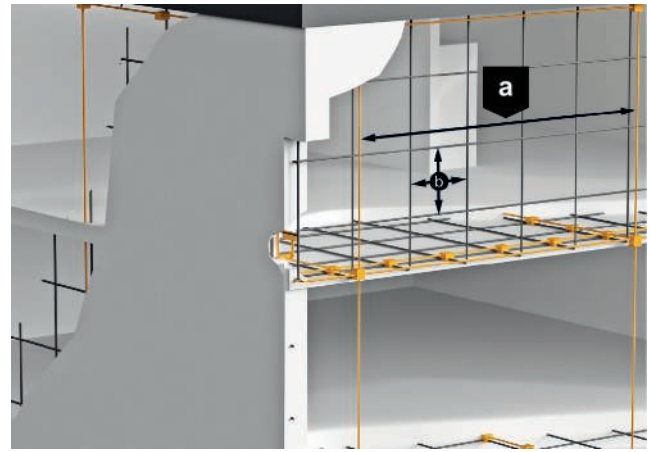

a	Down-conductor grid width = 5 m
b	Reinforcement mesh width = 1 m

Example: use of reinforced concrete supports/ down-conductor system

With systems made of prefabricated concrete and prestressed concrete sections, the electrical continuity must be checked with a continuity test between the top section and the earth.

#### Measurement

The total electrical resistance should be measured using a testing unit suitable for this purpose (DC source, 10 A measuring current).

Two types of measurement must be carried out:

- The resistance of the connection point of the reinforcement to the next connection point should be  $< 10$  m $\Omega$
- The connection point of the reinforcement with the main earthing rail should not exceed 10 m $\Omega$  per metre of building height.

Tests should ideally be carried out before and after filling with concrete. If these values are not achieved, then the steel reinforcement may not be used as a conductor. In this case, we recommend the erection of an external conductor. In building structures made of prefabricated concrete sections, the electrical continuity of the steel reinforcement of the individual prefabricated concrete sections with the neighbouring prefabricated concrete sections must be guaranteed.

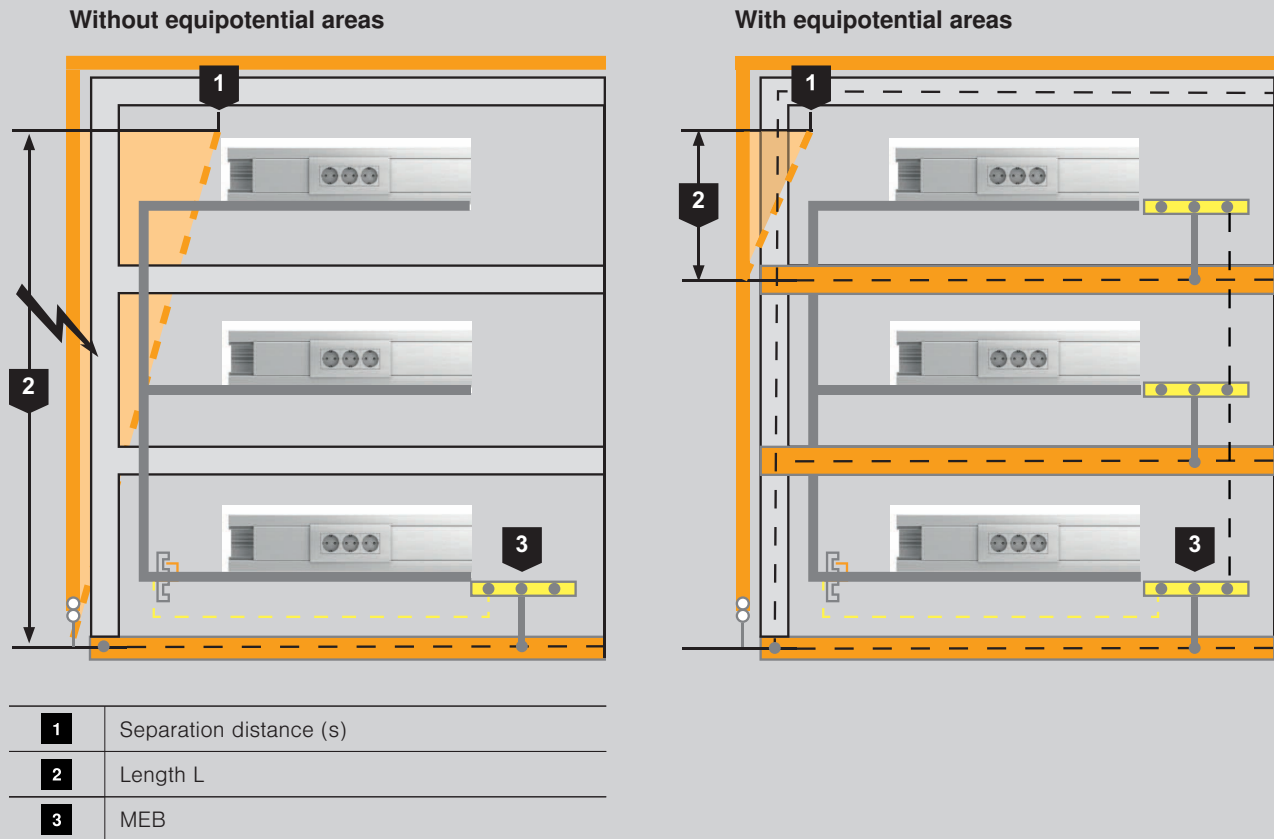

Separation distance for high buildings with and without equipotential area as reference level

### 2.2.10 Equipotential areas as the reference layer for calculating the separation distance in high buildings

In high buildings, conventional separation distance calculations can create separation distances which can no longer be implemented, as the length to the next reference level (e.g. earthing system or closest point of the equipotential bonding) is very long in the calculation (see Table 2.7) due to the building dimensions.

To still be able to plan and install a lightning protection system according to IEC/EN 62305-3, the creation of equipotential layers should be taken into account early in the project planning.

Creation of equipotential areas, e.g. on every 2nd or 3rd floor using:

- Lightning protection equipotential bonding through suitable lightning arrestors and surge protection devices for power and communication units
- Meshed earthing system according to DIN 1804
- Meshed ceiling reinforcement (multiple times in the building)
  - 5 x 5 m according to DIN EN 62305-4
- Connection to reinforcement every 2 m
- Lightning protection equipotential bonding of all metallic or electrical cables running into the equipotential levels (e.g. external cameras, luminaires, supply lines, PV systems, etc.)

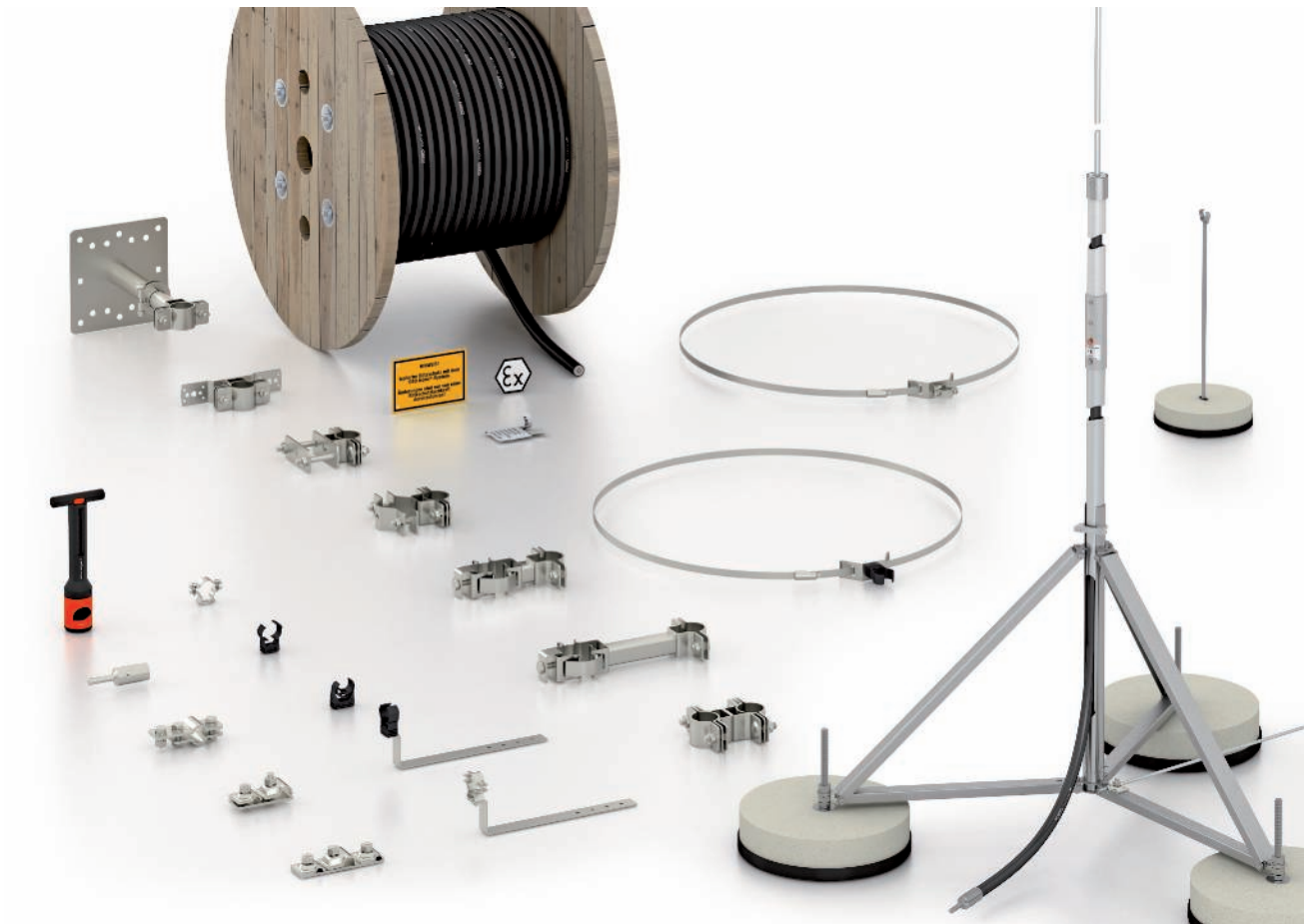

Components of the isCon® system

### 2.2.11 High-voltage-resistant, insulated conductor

For architectural reasons, it is often not possible to maintain the required separation distance in contemporary buildings. In these cases, and in industrial plants, the high-voltage-resistant, insulated isCon® conductor enables compliance with IEC 62305 and offers an equivalent separation distance of 0.75 m in air and 1.5 m in solid materials.

#### Overview of product benefits:

- No problems with the separation distance
- Universal: Simple termination on the construction site
- Conforms to the standard: cross-section of 35 mm<sup>2</sup> copper
- Tested: By independent testing institutes
- Flame-resistant
- Weatherproof
- Up to 200 kA lightning current per conductor
- Environmentally friendly: halogen-free
- Can be used in potentially explosive areas

*Insulated conductors are the best solution in situations where, for design or architectural reasons, separation distances cannot be adhered to.*

**Total flexibility in the design of the lightning protection system**

The isCon® conductor is a high-voltage-resistant conductor without creeping discharge. It permits adherence to separation distances according to IEC 62305-3 and can replace a separation distance of 0.75 m in the air and 1.5 m in the case of solid materials. These are properties confirmed by independent testing institutes.

**Structure of the isCon® conductor**

The OBO isCon® conductor consists of several parts. Its copper core has a cross-section of 35 mm<sup>2</sup> (IEC 62305 demands min. 25 mm<sup>2</sup>). It is surrounded by an internal conductive layer and high-voltage-resistant PEX insulation. In turn, this is surrounded by an external conductive layer and with an additional weakly conductive material. The lightning current flows through the copper core. For operation, the copper core must be connected to the weakly conductive jacket using a connection element. Only the tested connection element may be connected to the air-termination system or forwarding conductor of the external lightning protection. The conductor must be located in the protection area of the air-termination system and be fastened at distances of a maximum of one metre using the installation material indicated. If cables are routed in the building, then specified protection measures, such as fire insulation, must be taken into account.



Example: protection of a gas distribution point with isCon®conductor



<b>BASIC</b>		$s_e \leq 45 \text{ cm}$	150 kA	Ø 20 mm		Flat roof/ 2 storeys
<b>PROFESSIONAL</b>		$s_e \leq 75 \text{ cm}$	150 kA	Ø 20 mm		Industrial buildings
<b>PROFESSIONAL+</b>		$s_e \leq 75 \text{ cm}$	150 kA	Ø 23 mm		Chemicals in- dustry
<b>PREMIUM</b>		$s_e \leq 90 \text{ cm}$	200 kA	Ø 23 mm		Tower blocks

## 2.2.12 Versions

### 2.2.12.1 Non-isolated lightning protection system

If the necessary separation distance between the lightning protection system and the metallic systems of the building or the installation cannot be adhered to, further measures are required. To prevent dangerous sparking and a resulting fire risk, the following measures should be taken:

- Increase number of conductors (recalculate safety distance!)
- Create a connection between the systems that is capable of carrying lightning current

### 2.2.12.2 Isolated lightning protection system

Isolated lightning protection systems allow standard-compliant lightning protection according to IEC 62305. The separation distance to electronic systems required by the standard can be maintained by the different versions of the insulated lightning protection. The individual components and systems allow the creation of a very wide range of different solutions, according to requirements.



*Isolated lightning protection with insulating beams*



*Isolated lightning protection with isCon®*

*Sparks must be avoided in systems with an increased risk of explosion or fire.*



*Isolated lightning protection with air-termination rods*

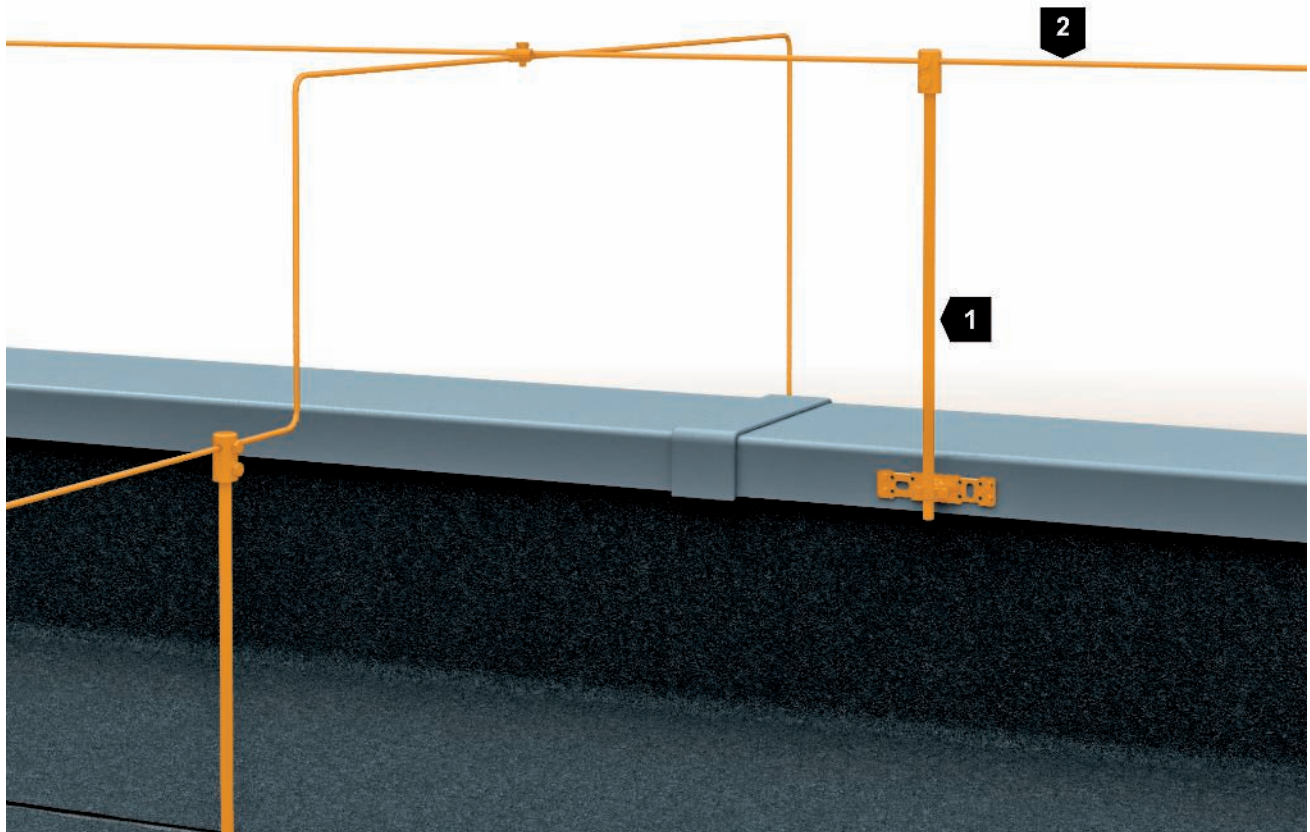

<b>1</b>	Insulated GRP holder
<b>2</b>	Round conductor

Insulated lightning protection with GRP rods

**Insulated lightning protection on an air-termination rod**

The insulated lightning protection system consists of GRP rods with a diameter of 16 or 20 mm:

- There is a comprehensive range of system accessories available for both variants
- Two material thicknesses
- Can be obtained as a set for different applications

16 mm GRP rods	20 mm GRP rods
0.75–1.5 and 3 m length	3 and 6 m length
UV-stable	UV-stable
Light grey	Light grey
Material factor (km): 0.7	Material factor (km): 0.7
Load torque: > 400 mm <sup>3</sup>	Load torque: > 750 mm <sup>3</sup>
Support load: 54 N (1.5 m)	Support load: 105 N (1.5 m)

Table 2.23: Properties of the insulated GRP rods

### 2.2.12.3 High-voltage-resistant isCon® conductor

#### Tasks of an insulated, high-voltage-resistant conductor

Insulated conductors are used in the field of external lightning protection to reduce or avoid the separation distance according to IEC 62305-3.

#### Requirements:

- Conductor connection with lightning current carrying capacity to the air-termination system, earthing system or standard exposed conductors run on towards the earth.
- Maintenance of the necessary separation distance (s) within the limits specified by the manufacturer through sufficient electrical voltage resistance of the conductor, both in the area of the supply point as well as in the entire onward course.
- Sufficient current carrying capacity through a standard conformant conductor cross-section of the arrester (OBO isCon® = 35 mm<sup>2</sup>, standard requires min. 28 mm<sup>2</sup>)

#### Normative requirements

Currently only the general requirements for:

- IEC 62561 Lightning protection system – Part 1: Requirements for connection components e.g. lightning current carrying capacity of the connection points
- IEC 62305 Protection against lightning – Part 3: Protection of structural facilities and persons, e.g. arrester system, min. cross-sections, equipotential bonding
- IEC TS 62561-8: Requirements for components for isolated LPS

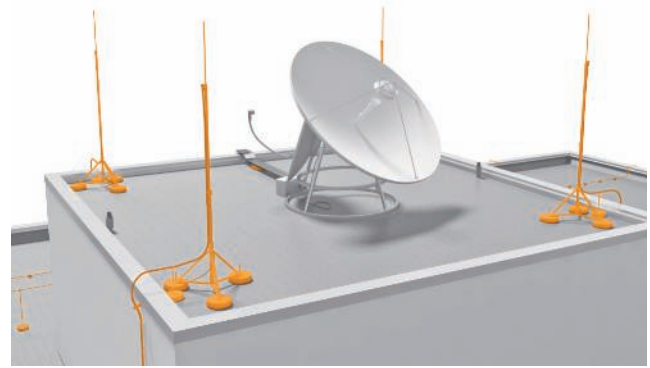

Isolated lightning protection with air-termination rods

#### isCon system: Areas of application – application examples

Insulated conductors are installation solutions for external lightning protection which can be used primarily in locations where the separation distance cannot be maintained or is not applied for aesthetic reasons.

Areas of application:

- Mobile telecommunications antennas
- Computer centres
- Expansions of lightning protection systems
- Architectural solutions
- Separation distance cannot be maintained

Geometry	Minimum cross-sections	Comments
Strip	50 mm <sup>2</sup>	Minimum thickness 2.0 mm
Round <sup>a</sup>	50 mm <sup>2</sup>	Diameter 8 mm
Cable	50 mm <sup>2</sup>	Minimum diameter of each wire 1.7 mm
Round	200 mm <sup>2</sup>	Diameter 16 mm

Table 2.23: Minimum cross-sections for conductors

<sup>a</sup> In certain situations, 50 mm<sup>2</sup> (8 mm diameter) can be reduced to 25 mm<sup>2</sup> if mechanical resistance is not a primary criterion. In this case, the spacing of the cable brackets should be reduced.

**Purpose of the insulated conductors**

If a direct lightning strike hits an installation with non-isolated lightning protection, arcing will take place onto earthed metal constructions or into electrical installations.

In an isolated system, a correctly calculated separation distance will ensure that the lightning current flows right through to the earthing system. If this is not practicable, a high-voltage-resistant insulated down-conductor can be used to maintain an equivalent separation distance.

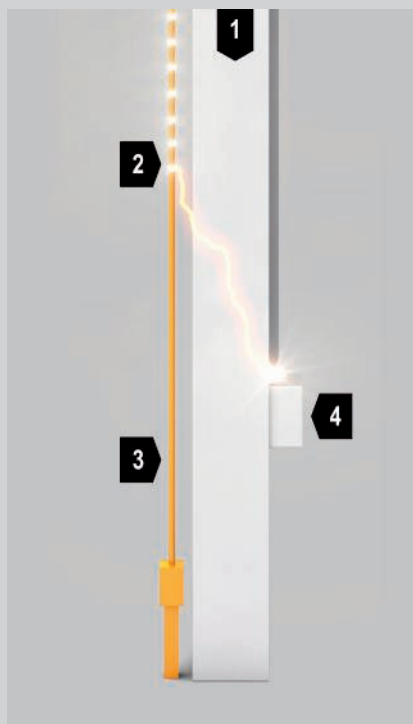

1	Masonry
2	Lightning current
3	8 mm conductor
4	Electrical installation

*Lightning current coupling into the electrical Installation.*

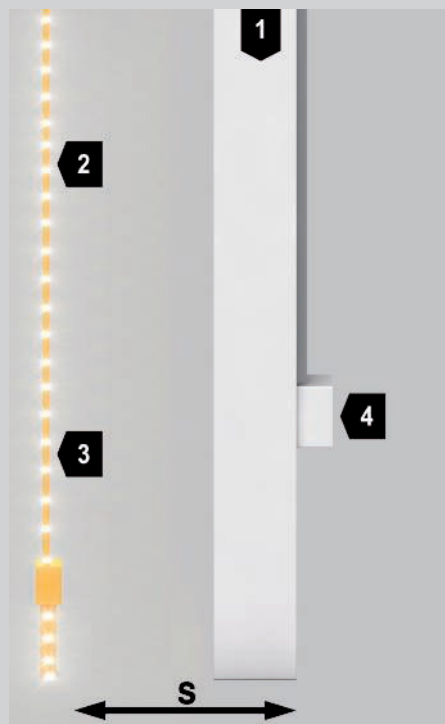

1	Masonry
2	Lightning current
3	8 mm conductor
4	Electrical installation
s	Separation distance

*No direct coupling*

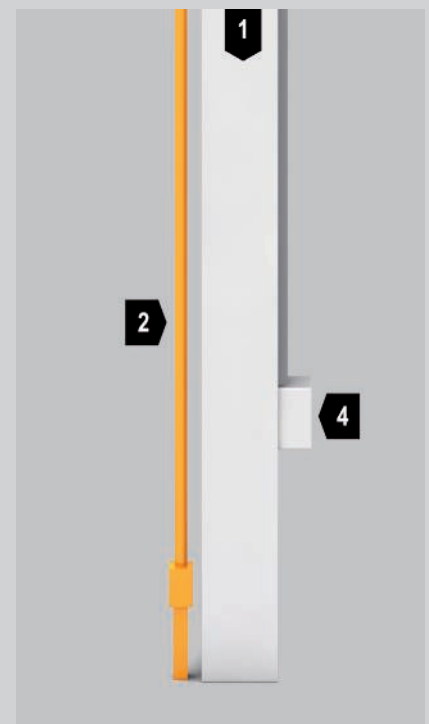

1	Masonry
2	isCon conductor
4	Electrical installation

*No direct coupling*





*isCon® = insulated conductor*

1	Protective jacket, EVA (ethylene vinyl acetate copolymer), UV-resistant
2	Conductive PEX (cross-linked polyethylene)
3	Insulating PEX (cross-linked polyethylene)
4	35 mm <sup>2</sup> copper cable

*Structure of the high-voltage-resistant OBO isCon® insulated conductor*

### OBO isCon® system

Insulated conductors are used in the field of external lightning protection to reduce or avoid the separation distance according to IEC 62305.

- In contrast to standard shielded medium-voltage cables with a metallic shield, insulated conductors possess a weakly conductive jacket for field control, de-energising the high voltage in the area of the supply point. This therefore prevents arcing via the cable jacketing of the insulated conductor.
- After the first potential connection of the cable jacket, the insulated conductor secures the specified equivalent separation distance.

### Structure of the high-voltage-resistant OBO isCon® insulated conductors

The isCon® conductor is a single wire cable with a coaxial structure. It consists of several layers of conductive, slightly conductive and insulating material, and the internal conductor with corresponding conductivity. Thanks to this structure, both a sufficient dielectric strength of the insulation in case of lightning voltage impulses and targeted manipulation of the electrical field strength at both ends of the cable is possible. This prevents the creeping discharges that would otherwise occur.

Creeping discharges always occurs on boundary surfaces between a solid and gaseous insulating material. Due to the heterogeneous electrical fields, local peaks in field strength occur which, when the inception voltage for creeping discharge is reached, trigger discharge along the surface of the conducts.

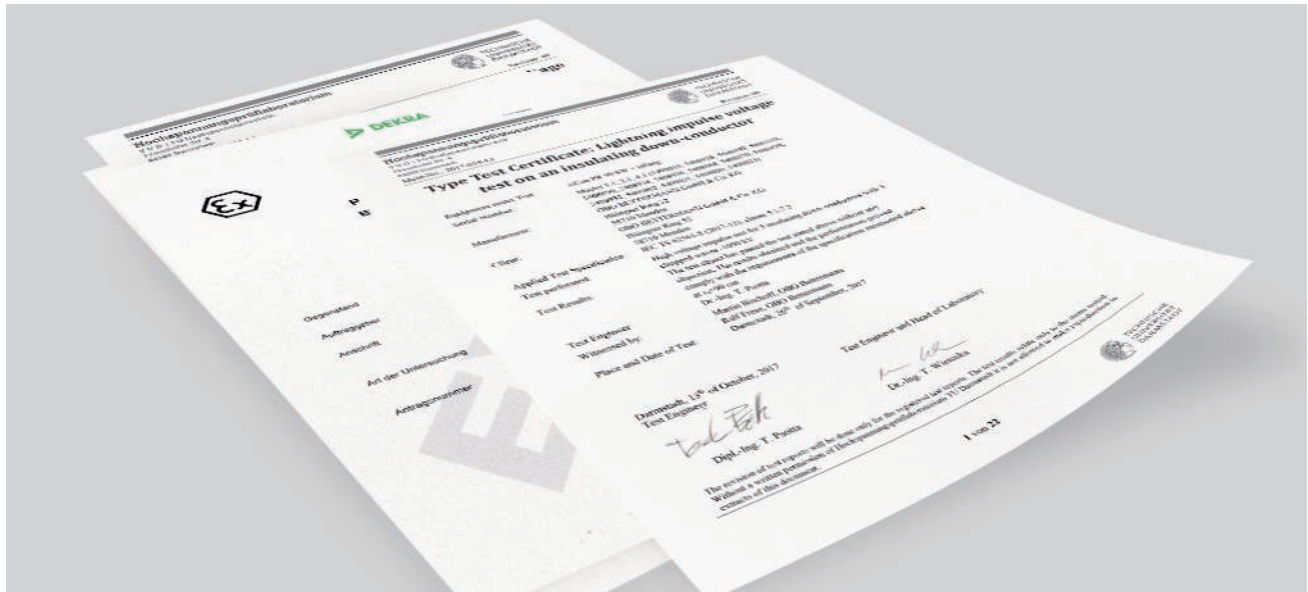

Test reports for the isCon® conductor

**Separation distance**

Calculation of the separating distance according to IEC 62305-3 Section 6.3 at the connection point of the isCon® conductor: the length (l) between the connection point of the isCon® conductor to the next level of the lightning protection equipotential bonding (e.g. earthing system or equipotential level) must be measured. It must be checked whether the calculated separation distance (s) is less than the specified equivalent separation distance of the isCon® conductor. If the specified separation distance is exceeded, then additional conductors must be installed.

**Note**

The values in the table apply to all type B earthers and to those type A earthers in which the earth resistance of the neighbouring earther electrodes does not differ by more than a factor of 2. If the earther resistance of individual electrodes deviates by more than a factor of 2,  $k_c = 1$  should be assumed. Source: Table 12 of IEC 62305-3.

LPD lightning protection class	Max. lightning current peak value	Number of conductors	Basic	Pro Pro+	Premium
			Length for $s \leq 0.45$ m in air	Length for $s \leq 0.75$ m in air	Length for $s \leq 0.90$ m in air
I	200 kA	1	-	-	11.25 m
		2	8.52 m	14.20 m	17.05 m
		3 and more	12.78 m	21.31 m	25.57 m
II	150 kA	1	7.50 m	12.50 m	15.00 m
		2	11.36 m	18.94 m	22.73 m
		3 and more	17.05 m	28.41 m	34.09 m
III+IV	100 kA	1	11.25 m	18.75 m	22.50 m
		2	17.05 m	28.41 m	34.09 m
		3 and more	25.57 m	42.61 m	51.14 m

Table 2.25: Maximum length of the isCon® conductors in air

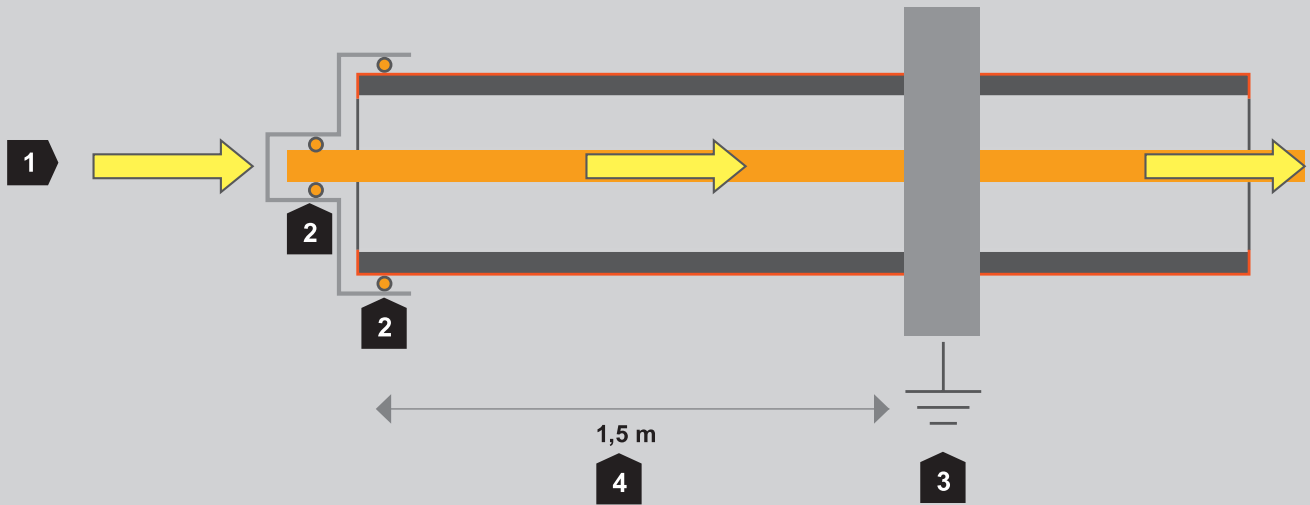

1	Lightning current, several kA
2	Connections between copper cable and sheath
3	Electrical connection to building, conductive structure, local PAS
4	Minimum spacing (smaller values are possible based on calculation)

Functioning of the isCon® conductor



### Rules for the planning and installation of parallel isCon® conductors

Current division occurs in an installation of multiple insulated conductors, run in parallel. The reduced current division coefficient  $k_c$  thus also reduces the calculated separation distance ( $s$ ).

To keep the magnetic fields as small as possible and avoid interference between the cables, it is wise to keep the cables at least 20 cm apart. Ideally, the second conductor should be run to the ground on the other side of the building.

When conductors are routed directly beside one another, the inductivity of the total arrangement is not reduced by the factor  $n$ , and the current division coefficient is not reduced accordingly. An exact calculation of the separation distance provides evidence of whether the isCon<sup>®</sup> conductor can be used, see Table 2.25.

*The high-voltage-resistant insulated isCon<sup>®</sup> conductor fulfils the requirements of the standard by offering an “equivalent separation distance”.*



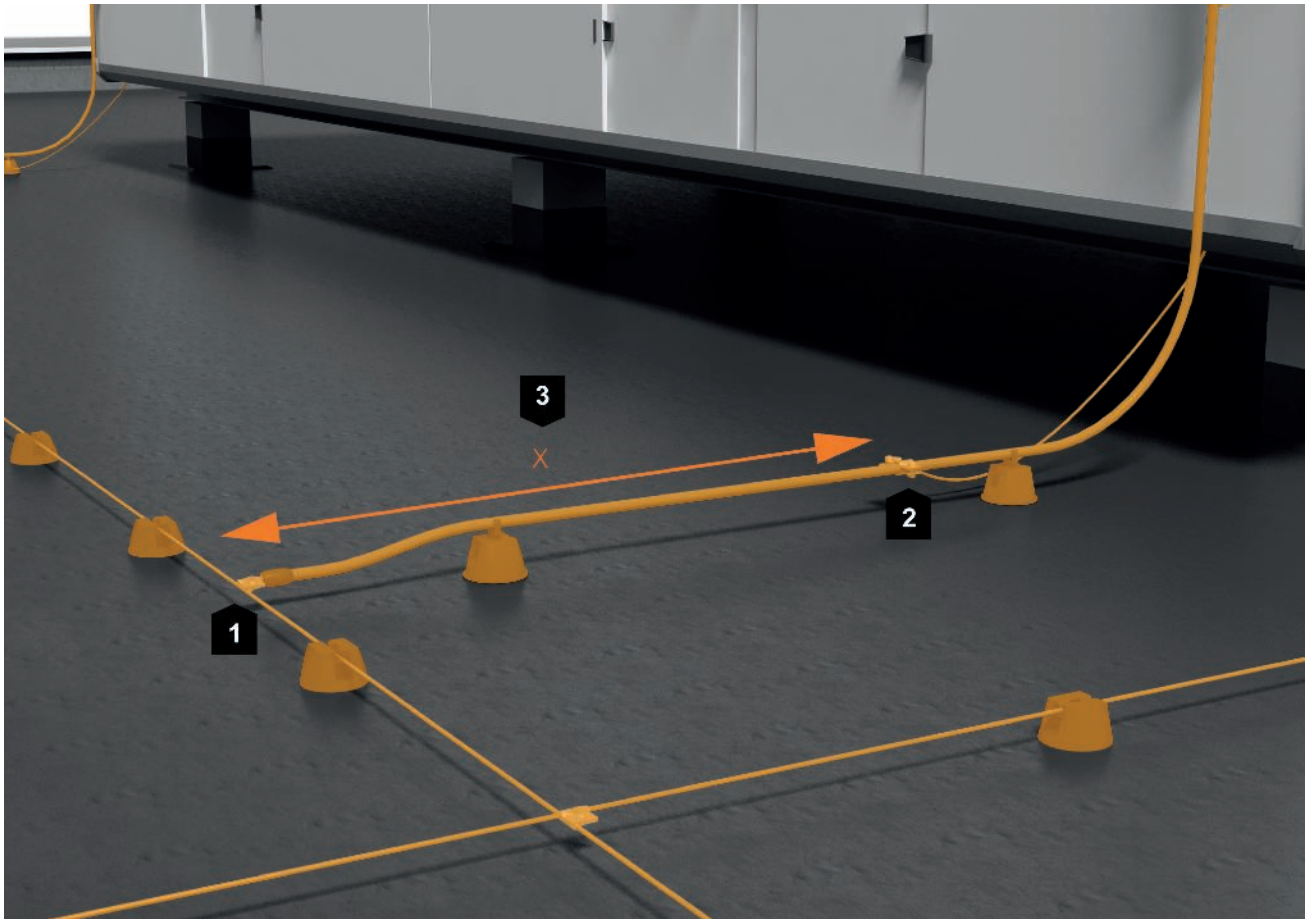

1	Connection element
2	Potential connection with e.g. Cu cable of $> 6 \text{ mm}^2$
3	x: minimum distance (smaller values are possible based on calculation)

Connection of isCon® to mesh

### isCon®: Potential connection

- The potential control element should be connected to a reference potential using  $\geq 6 \text{ mm}^2$  Cu or an equivalent conductivity.
- Lightning current must not flow through the reference potential and it must be in the protective angle of the lightning protection system.
- This means that the potential connection can be made via a local equipotential busbar, metallic and earthed roof structures, earthed parts of the building structure and via the protective conductor of the low-voltage system.
- Equipotential bonding (connection  $\geq 6 \text{ mm}^2$ ) not necessary for separation distance  $\leq 0.15 \text{ m}$
- Throughout both connection areas, the respective calculated separation distance (s) to the metal parts must be maintained.

No electrically conductive or earthed parts may be located in the area between the connection element and the potential connection in the radius of the calculated separation distance. These include, for example, metallic construction parts and cable brackets as well as assemblies. If the calculated separation distance (s) is less than the equivalent separation distance of the appropriate isCon® conductor, then the distance between the potential connection clip and the connection element (x) can be reduced accordingly.

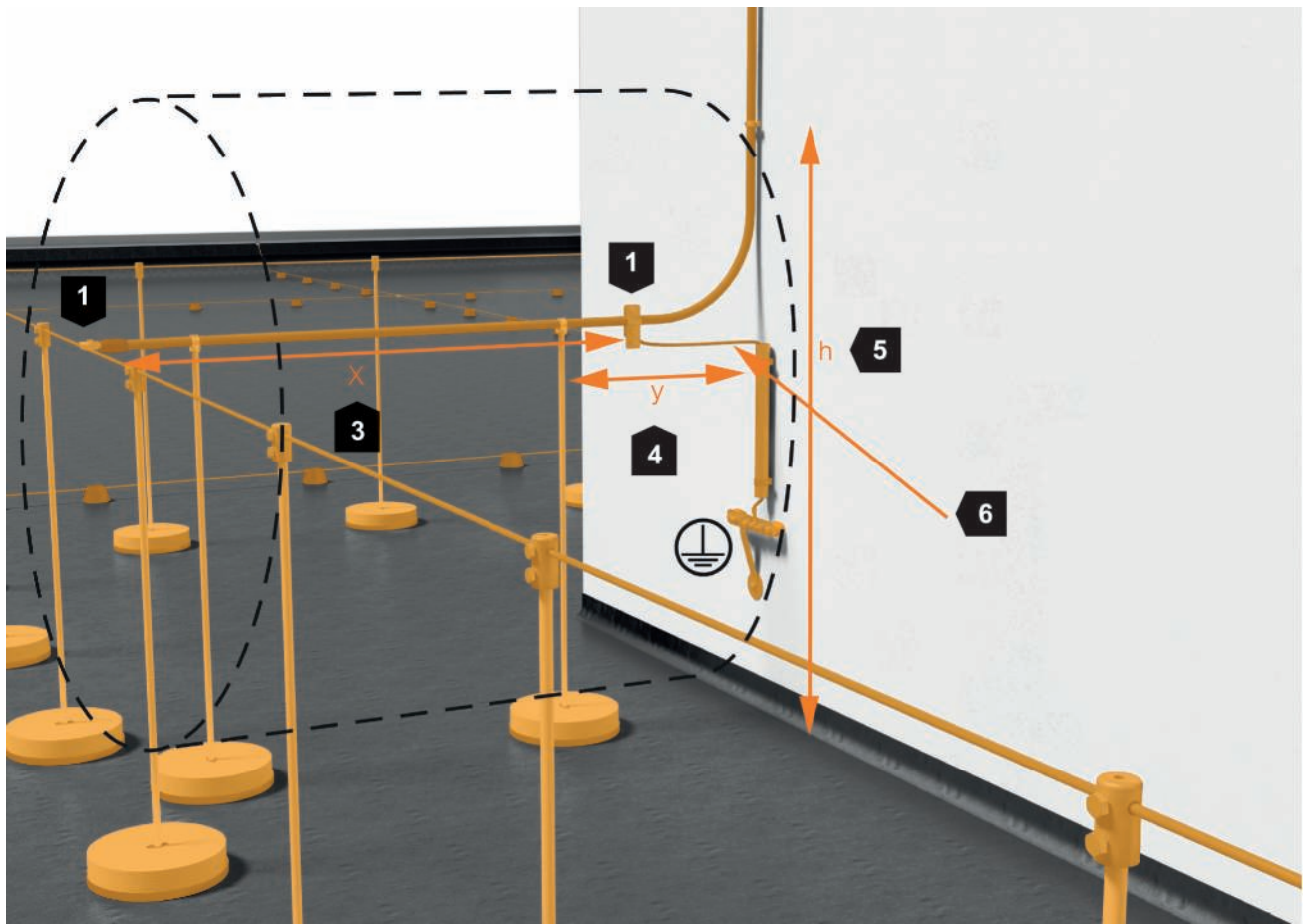

Example: isCon® conductor on isolated ring circuit

1	Connection element
2	Potential connection
3	x: Minimum distance (smaller values are possible based on calculation)
4	y: Distance from GRP holder to wall
5	h: Distance from wall mounting to flat roof
6	Equipotential bonding = 6 mm <sup>2</sup>

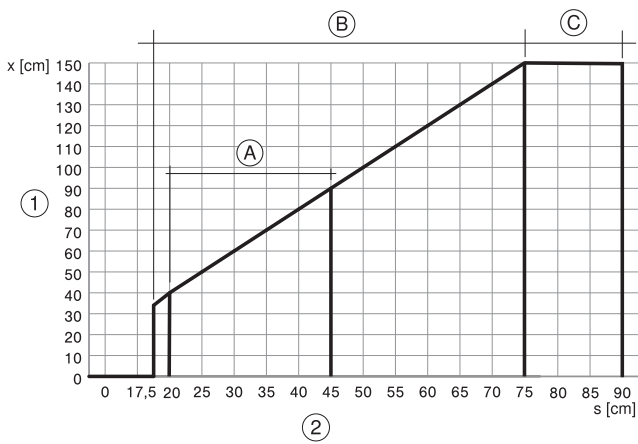

- ① Clip distance (x) from the potential connection terminal to the connection element in cm
- ② Calculated separation distance (s) in cm
- Ⓐ isCon BA 45 SW
- Ⓑ isCon Pro+ 75 SW/GR and isCon Pro 75 SW
- Ⓒ isCon PR 90 SW



Table 2.26: Minimum required distance between connection element and potential connection terminal  $s = 0.75 \text{ m}$  in air

isFang air-termination rods with external isCon® conductor

In complex installations, the required separation distance can often no longer be implemented with conventional conductors, as the structural conditions do not permit the required distances between the air-termination systems and the electrical installations. Insulated lightning protection systems, such as the OBO isCon® conductor, are used to maintain the required separation distance nonetheless.

#### **Total flexibility on the construction site**

The OBO isCon® conductor can be used flexibly. The isCon® conductor is delivered on disposable cable rolls. This means that the user can cut them to the exact size they require and terminate them as necessary. This means: no ordering of pre-terminated cables, but rather flexible working according to actual conditions on the construction site. Special knowledge is required to be able to carry out the planning and routing of the isCon® conductor correctly. This knowledge is imparted by the current installation instructions, but can also be deepened in special OBO workshops.

#### **Halogen freedom**

The use of halogen-free cables prevents the formation of corrosive and toxic gases during construction. The gases can cause considerable damage to people and property. The costs resulting from the corrosiveness of the fire gases are often higher than the costs caused by direct fire damage. The OBO isCon® conductor is made from halogen-free materials.

#### **Behaviour in case of fire**

A fire can spread along a non-flame-resistant cable in just a few minutes. Those cables are considered flame-resistant that prevent the spread of fire and which extinguish themselves after the ignition flame is removed. The flame resistance of the OBO isCon® Pro+ conductor was proven according to DIN EN 60332-1-2.

#### **Application example: soft-covered roofs**

Soft-covered roofs such as straw, thatch and reed require extra protection against lightning and the associated fire risk.

An isolated lightning protection system achieved by using isCon® conductor is recommended in order to comply with the aesthetic expectations of builders and architects. The air-termination system is implemented using air-termination rods, which allow the conductor to be routed in their interior (type isFang IN). The grey version of the isCon® conductor guarantees a high level of protection and can be used for soft roofs. In this way, the conductor can be routed under the soft roof.



*Soft-covered roof with isCon®*

**Application example: mobile telecommunications system**

Installations such as mobile telecommunications systems must be included in the lightning protection concept, particularly in the case of refitting work.

Spatial restrictions, as well as the influence of transmission signals, can be overcome by constructing the lightning protection system using an isCon® conductor. Simple inclusion in the existing lightning protection system as well as separate lightning protection can be implemented simply and in accordance with the standards.

**Aesthetic aspects**

In easily visible areas, as well as wherever aesthetics are important, we recommend routing the isCon® conductor in the air-termination rod. Equipotential bonding after the first 1.5 metres takes place in the rod. The entire retaining pipe is earthed, guaranteeing comprehensive equipotential bonding. A simple and visually perfect installation solution.

*A surveyor's report on problem-free routing of the isCon® Pro+ -conductor in the area of fire locks is available for composite heat insulation systems (WDVS)!*



Cell tower with isCon® conductor



CCTV cameras with isCon® conductor



**2.2.13 New technical specification IEC TS 62561-8 for insulated external lightning protection systems with insulators and high-voltage-resistant, insulated conductors according to IEC/EN 62305-3**

**2.2.13.1 Problem**

Increasingly, in structures, the electrical equipment is being moved onto the roof. In addition, the EMC requirements play an ever greater role. An external lightning protection system, consisting of an air-termination system, a conductor system and an earthing system, can also make a contribution to the preventive fire protection and EMC protection of a building. The erection of an external lightning protection system according to IEC/EN 62305-3 allows the arrangement of a separate lightning protection system, which is insulated from the metallic or electrical systems of a structure. This insulates the air-termination system and conductor system from the structure, i.e. set up at a distance to the building to be protected. Such an insulated structure is required, for example, if the structure or part of the structure should not carry lightning current, but is located in the protection area of the insulated external lightning protection system. The image alongside shows a typical application of an insulated lightning protection system on a building to protect the technical systems located on the building.

To implement an insulated external lightning protection system, metallic conductors can be applied through insulators, such as GFK bracket units, at a separation distance (s) according to IEC/EN 62305-3.



<b>1</b>	Insulator
<b>2</b>	Conventional conductor
S	Separation distance
U	Induced voltage

*Insulated external lightning protection system with insulators*

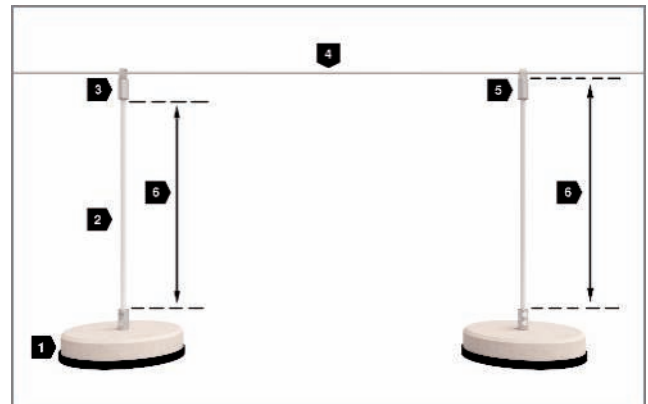

<b>1</b>	Fastening stand
<b>2</b>	Insulator
<b>3</b>	Metal bracket
<b>4</b>	Conventional conductor
<b>5</b>	Plastic bracket
<b>6</b>	Separation distance

*Definition of the separation distance for insulators*

This separation distance (s) can also be achieved through high-voltage-resistant insulated conductors, whereby the high-voltage-resistant conductor can be routed directly on the surface of the structure.

The requirements and type tests for insulators and high-voltage-resistant insulated conductors are specified in the newly released IEC TS 62561-8. In the technical and architectural fields, a high-voltage-resistant, insulated conductor can offer considerable benefits compared to the mechanical set-up with insulators. An insulated conductor can be installed to be invisible behind metallic facades, under thatched roofs or behind glass facades. In every case, the galvanic decoupling of the lightning current by the structure protects the electrical roof structures against the impacts of a direct lightning strike.

This not only offers benefits in industry, e.g. in potentially explosive areas, but can represent a key area of preventive fire protection and the guarantee of EMC in any structure. The impact of the magnetic field created by the lightning current on the structure cannot be prevented by an isolated external lightning protection system. However, the level of the magnetic field within a structure is given by the shielding action of the installed metallic structures of the building. The impact of the magnetic field can be reduced within the structure through further shielding measures described in IEC/EN 62305-4.

The electrical installation of the building should also be protected against the impacts using suitable SPDs (surge protection devices). However, the major benefit of an insulated external lightning protection system is the reduction of potential differences in the equipotential bonding system of the structure. Together, an insulated external lightning protection system and shielding measures make a contribution to the guarantee of the electromagnetic compatibility and thus to the safe operation of electrical systems in the case of a lightning strike.

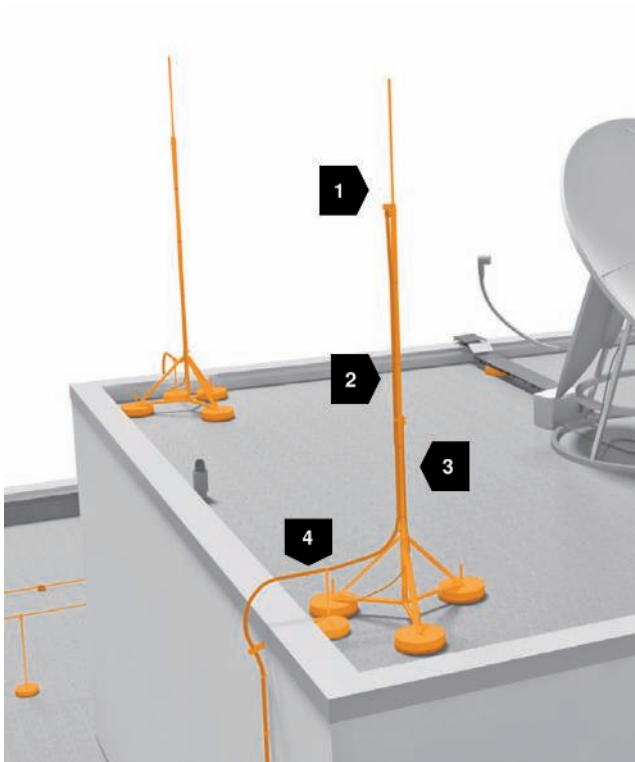

1	Air-termination system
2	Insulated conductor (4) fastened to an insulating pipe (2)
3	Metal fastening stand
4	Insulated conductor

Insulated external lightning protection system with isCon®

**2.2.13.2 Insulated external lightning protection system with insulators**

An insulator should keep conductors routing lightning current at a distance from metallic structures and electrical systems, provide insulation against the induced voltage in case of a lightning strike and resist the environmental loads, such as ultraviolet radiation and soiling, and the tension and pressure forces resulting from snow, ice and wind. However, insulators are a part of a mechanically coupled system made up of insulating materials and ladders.

The most important requirement is the compliance of the necessary separation distance, even if the insulator is moved. The separation distance is defined in DIN EN 62305-3 (IEC 62305-3) and contains the coefficient  $k_m$ . Instead of  $k_m$ , the manufacturer states the effective length correction factor  $k_x$ , which is confirmed in a type test.  $k_x$  specifies the ratio of the standing lightning pulse voltages of an air spark gap and an insulator aged by UV radiation.

$k_x = I_{eff}/I_{st}$  : Effective length correction factor

$I_{eff}$  : Strike distance of an air spark gap with equivalent discharge behaviour of an insulator.

$I_{st}$  : Thread measure of the insulator

Further type tests are described in IEC TS 62561-8 and contain the following points:

- Documentation
- Labelling
- Construction
- Ultraviolet light
- Corrosion
- Extraction force
- Bend test
- Impact test
- Electrical testing

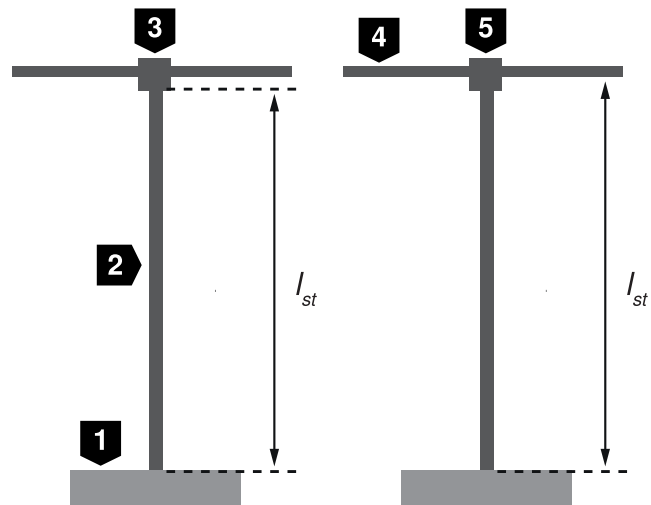

<b>1</b>	Stand
<b>2</b>	Insulator
<b>3</b>	Metal bracket
<b>4</b>	Air-termination system/conductor
<b>5</b>	Insulated holder
$I_{st}$	Thread measure of the insulator

Definition of thread measure of the insulator

The following applies for the calculation of the separation distance according to IEC/EN 62305-3:

$$k_m = k_x$$

### 2.2.13.3 Isolated external lightning protection system with insulated, high-voltage-resistant conductors

A high-voltage-resistant, insulated conductor should withstand the induced voltage in the event of a lightning strike and resist the environmental loads, such as ultraviolet radiation and soiling, the tension and pressure forces resulting from snow, ice and wind, as well as the electrodynamic forces.

An insulated conductor, as shown in the image below, can be developed, if, instead of the air around the bare conductors being used as the insulating material, it is assumed that the bare conductor is surrounded by a virtual solid insulating material. Due to the increased resistance of a solid insulating material compared to air, the insulation thickness around the conductor can be reduced to a few millimetres. At first glance, this allows routing of the insulated cable directly on the shell of the structure.

However, the transition of the insulated conductor in the critical area of the building edge and connection of the insulated conductor to the air-termination system require special additional measures to avoid floating discharges.

The field of medium and high-voltage technology has shown that floating discharges can occur at the ends of cables. In these applications, to avoid floating discharges, the cable is given a cable termination for potential control. The same problems must be solved for the insulated conductor. However, there is the difference that there is never alternating current at an insulated conductor and only a few voltage and current loads will occur during the entire lifespan of a structure. The requirements for special potential control for insulated conductors in lightning protection are derived from this.

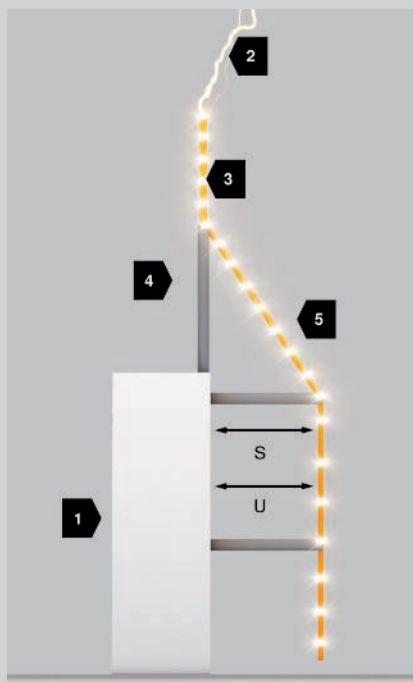

1	Structure
2	Lightning channel
3	Insulated air-termination device
4	Insulator
5	Conventional conductor
L	Separation distance
U	Induced voltage

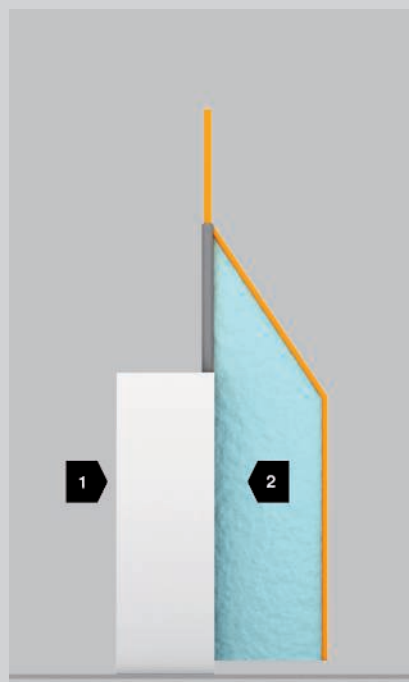

1	Structure
2	Virtual solid insulation material

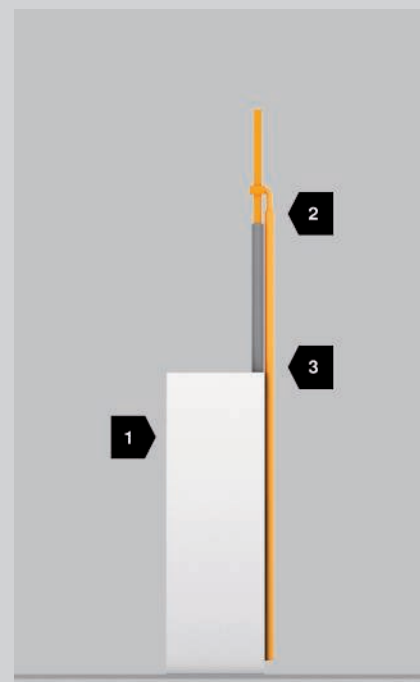

1	Structure
2	Virtual solid insulation material replaced with insulated conductor
3	Critical area

Development of an insulated, high-voltage-resistant conductor

Thus, measures to avoid floating discharges can be selected without taking thermal effects in alternating current into account. A resistive field control has shown itself to be particularly suitable and robust. This avoids the formation of damaging floating discharges through the appropriate control of the electrical field strength in the critical area of the transition to the air-termination system.

Here, in a manner similar to medium and high-voltage cables, the internal conductor is surrounded with a weakly conductive internal conduction layer, to which the actual insulating material is attached. The weakly conductive layer is attached to this insulating material. The two conduction layers compensate for unevennesses, thus ensuring even field distribution.

However, the metallic shield used for medium and high-voltage cables is technically undesirable for insulated conductors. In contrast to the medium and high-voltage network, the inductive coupling, created by the lightning impulse current, induces a very high voltage onto the cable shield. In turn, this voltage requires the maintenance of a separation distance between the shield and the system to be protected. Undershooting this separation distance would lead to arcing and to the coupling of a high impulse current into the systems to be protected [Beierl].

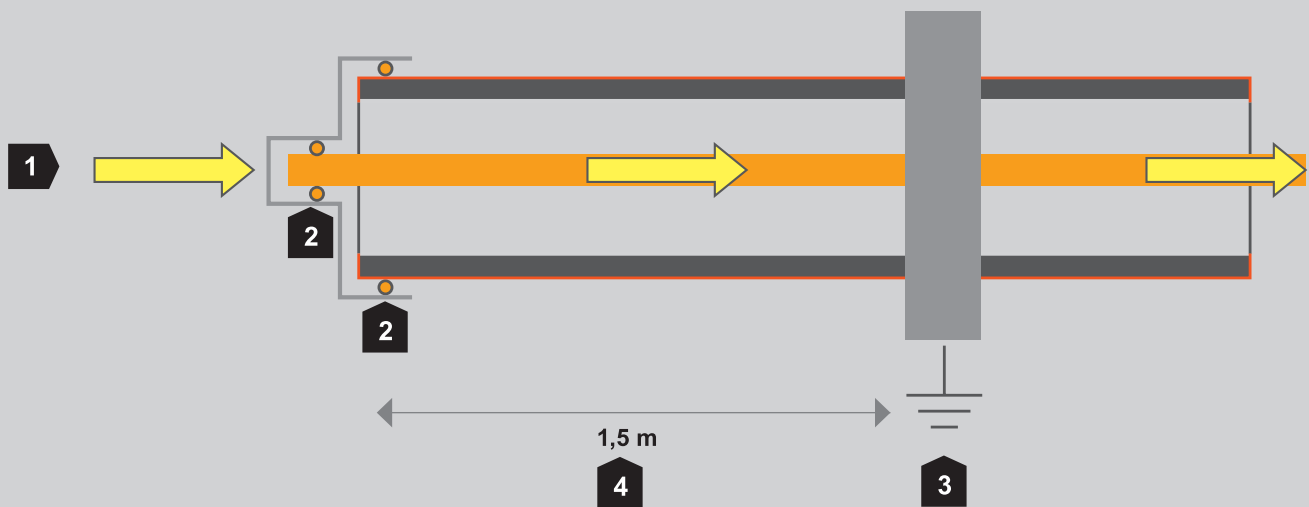

<b>1</b>	Lightning current, several kA
<b>2</b>	Connections between copper cable and sheath
<b>3</b>	Electrical connection to building, conductive structure, local PAS
<b>4</b>	Minimum spacing (smaller values are possible based on calculation)

Function of the isCon® conductor

### 2.2.13.4 Potential control

For safe operation of an insulated conductor, measures to avoid floating discharges are necessary. As an induced voltage is only present on an insulated conductor when lightning strikes, a resistive field control can be used to avoid floating discharges. The lower the resistance is designed to be, the more effective it is. The value is limited in a downward direction so that no partial lightning current can flow into the building. In an upward direction, the value is given by the requirement for effective field control.

The voltage load on a lightning strike is an impulse voltage. Using the numerical field calculation, the resistive field controller can be calculated in a time-discrete manner for the entire course of the impulse voltage. This allows optimisation of the resistance value of the resistive field controller. For this, the testing arrangement is used as a basis, which is also used for the high-voltage testing according to IEC TS 62561-8 and represents the worst-case scenario. As an example, the left image shows the field diagram of this arrangement with an applied impulse voltage of 1,000 kV in the area of the equipotential bonding terminal.

Here, equipotential lines and the vertical electrical field lines can be seen. Within the external conductive layer and in the resistive field control layer, the current lines can be seen, which are significant for avoiding floating discharges. The right-hand image uses a cross-section diagram to show the current density vectors and equipotential areas. Both diagrams show how the numerical, time-discrete field calculation can be used to optimise the resistive field control so that the current in the field control layer can be kept as small as possible, whilst still avoiding the formation of floating discharges.

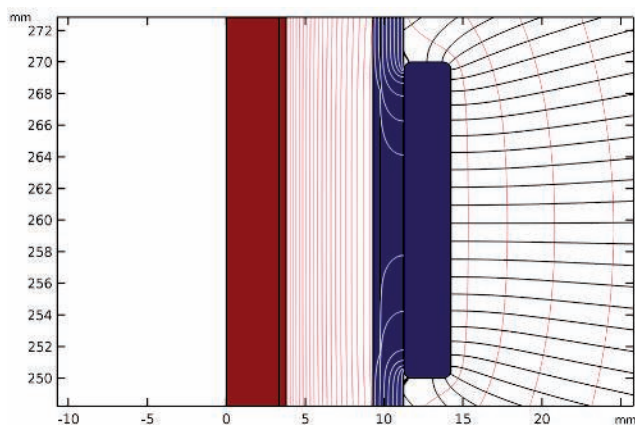

Field diagram of an insulated conductor at the first equipotential bonding terminal during a type test at time  $t = 1.2 \mu\text{s}$  of the applied impulse voltage 1.2/50.

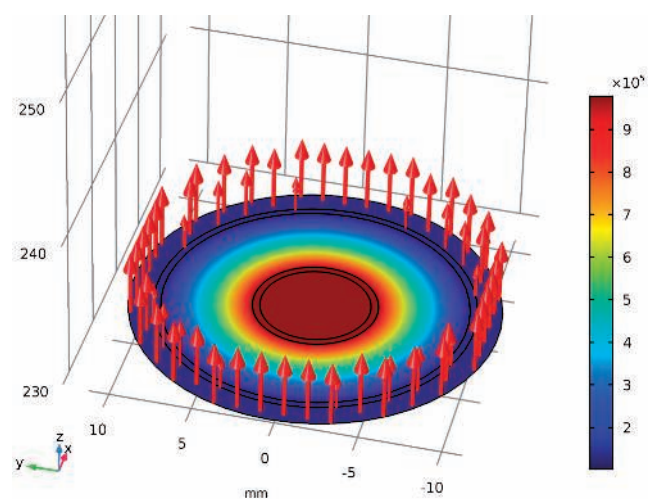

Current density vectors in resistive field control and potential density of an insulated conductor at time  $t = 1.2 \mu\text{s}$  of the applied impulse voltage 1.2/50 20 cm below the earthed fastening clamp. A potential of 1,000 kV is applied to the internal conductor.

### 2.2.13.5 Technical solution for an insulated high-voltage-resistant conductor

The insulation material is not constantly subject to voltage, meaning that aging processes do not play a role on medium and high-voltage cables of the power supply. During the expected lifespan of a lightning protection system, an insulated, high-voltage-resistant conductor must withstand multiple lightning events. For this reason, the insulating material can be used up to close to the limit of the theoretical resistance of 250 kV/mm [Ushakov]. However, this assumes the use of high-quality materials for the internal and external conductive layer, the insulating material and for the resistive field control. The properties of the materials are checked in a high-voltage test.

Beginning with the secured operating field strengths for 50 Hz in the long-time range, the following image shows an extrapolation of the field strength for the short-time range of a few 100 ns. The extrapolation covers the theoretical field strength given by Ushakov for the short-time range of 250 kV/mm for the time range of 100 ns. From the type tests carried out, the field strengths effective in the test can be calculated and are shown as points in the image. They match the theoretical field strength.

The below image shows a finished and patented design of an insulated, high-voltage-resistant conductor. In so doing, the cross-section of the copper conductor is selected in such a way that sufficient lightning current carrying capacity and acceptable flexibility for routing are given, but, at the same time, the standard specifications from IEC/EN 62305-3 are fulfilled.

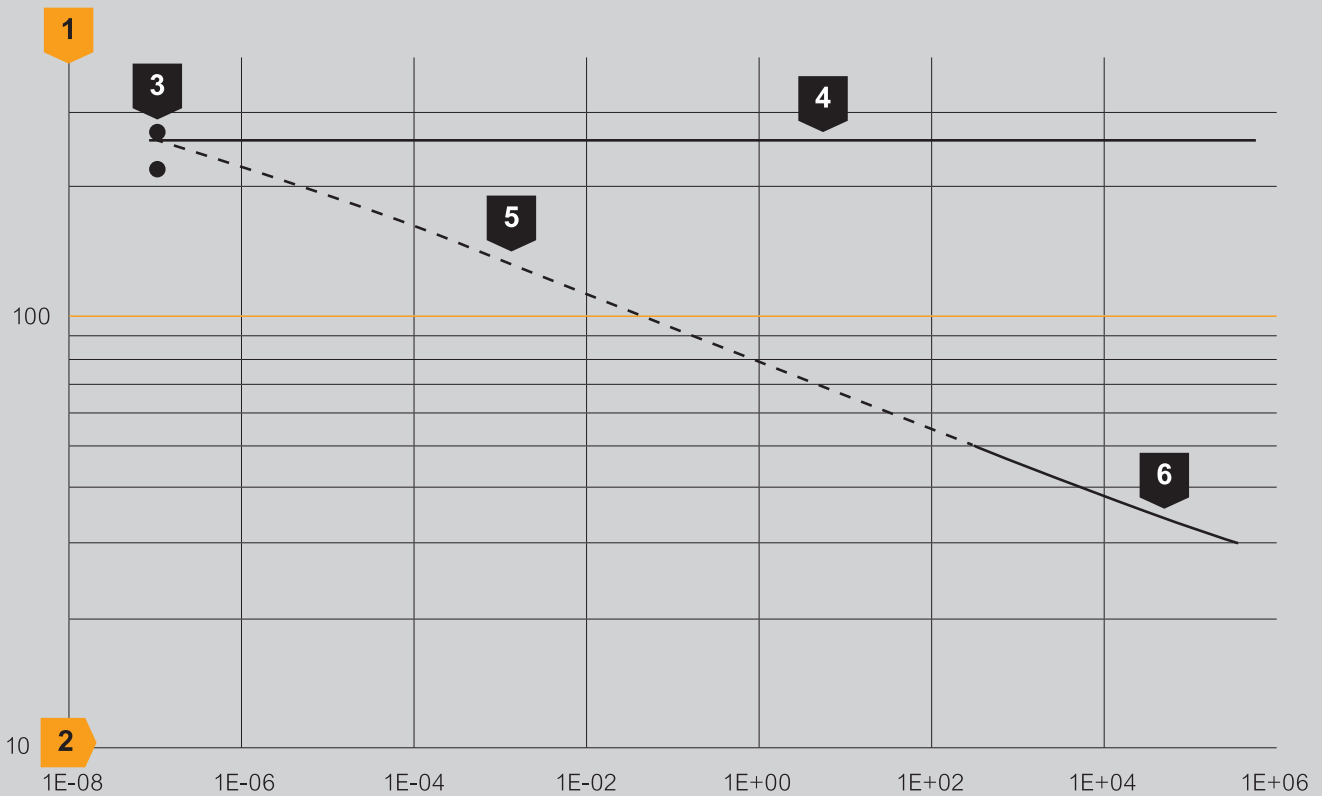

Overview of the electrical field strength for insulation materials of high-voltage cables and extrapolated values for the short-time range, as well as two protected values from type tests of insulated conductors.

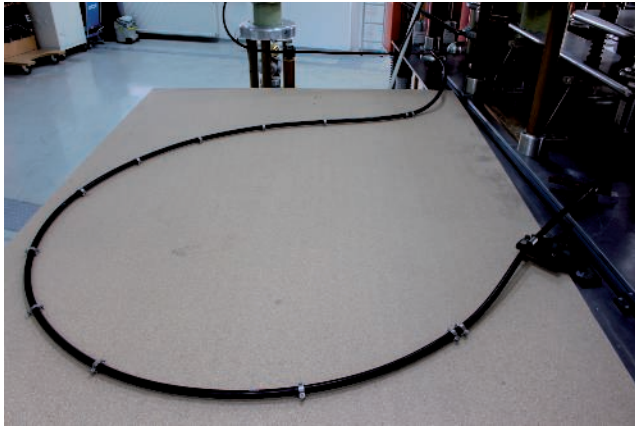

Structure of an insulated conductor to test the lightning current carrying capacity, e.g. with 200 kA



Testing structure during an impulse voltage test with an equivalent separation distance ( $s_e$ ) of 75 cm.

### 2.2.13.6 Type tests for insulated conductors

The recently published technical specification IEC TS 62561-8 specifies the requirements and type tests for insulated down conductors [Meppelink]. The key test is the proof of the equivalent separation distance ( $s_e$ ) of the insulated conductor. Before this type test, three samples to be tested are subjected to an impulse current test with the indicated rated current, e.g. 200 kA.

An evaluation of the transition resistances and release torques of the screw connections according to IEC 62561-1 can only be carried out after the high-voltage test. After a static, mechanical load with 900 Nm, as shown in the "Testing structure of the static mechanical load", the insulated conductor is connected with an air-insulated comparative spark gap to an impulse voltage of 1.2/50. The distance to the comparative spark gap is adjusted to the distance of the indicated separation distance using a correction factor specified in the standard.

Through three impulse voltage loads for each sample, it must be proven that the comparative spark gap flashes over and no disruptive breakthrough or arcing occurs on the insulated conductor. This proves the equivalent separation distance ( $s_e$ ).

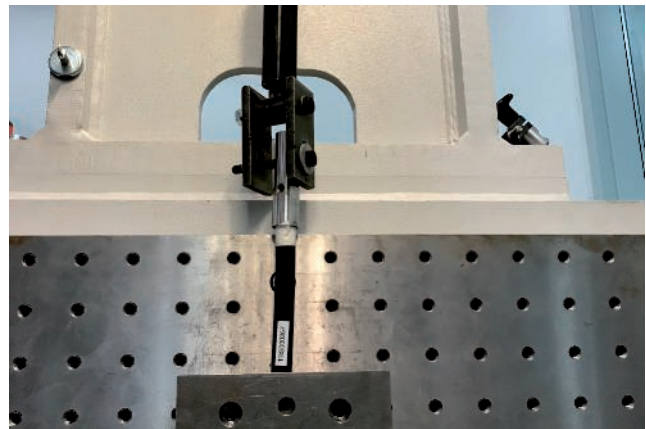

Testing structure of the static mechanical load

An example of the test structure is shown, along with a registered load with disruptive breakthrough of the comparative spark gap adjusted to an equivalent separation distance ( $s_e$ ) of 75 cm. As this arcs and not the high-voltage-resistant, insulated conductor in parallel, an equivalent separation distance ( $s_e$ ) of 75 cm can be proven for this conductor type.

Further type tests are described in IEC TS 62561-8 [Meppelink] and contain the following points:

- Documentation
- Labelling
- Construction
- Ultraviolet light
- Tension and bend test
- Corrosion
- Impact test
- Electrical testing with impulse current
- Electrical testing with impulse voltage



### 2.2.13.7 Summary

The lightning protection components for insulated external lightning protection systems are now offered according to IEC TS 62561-8. The tested components secure the function of the insulated external lightning protection systems under the named environmental loads and when subjected to lightning. From the point of view of the erection of lightning protection systems, insulated external lightning protection systems make an important contribution to the protection of any structure against the impacts of lightning, and an important contribution to the electromagnetic compatibility of electrical systems.



Source directory:

Ushakov, Vasily Y.: *Insulation of High-Voltage Equipment*. Springer-Verlag Berlin and Heidelberg GmbH & Co. KG (22nd October 2010). ASIN: B017WOLFJ6

Meppelink, J.; Bischoff, M.: *IEC 62561-8 Isolierte Blitzschutzsysteme*. 12. VDE/ABB Blitzschutztagung Aschaffenburg 2017

Beierl, O.: *Wirkungsweise niederimpedanter isolierter Ableitungen*. 12. VDE/ABB Blitzschutztagung Aschaffenburg 2017

### Installation principle for isCon® in potentially explosive areas

In Ex zones 1 and 21, after the first potential connection, the OBO isCon® Pro+ conductor should be connected at regular distances (0.5 metres) using a metallic cable bracket (e.g. isCon® H VA or PAE) to the equipotential bonding. If there is a lightning strike, the equipotential bonding must not carry lightning current and must be in the protection angle of the lightning protection system.

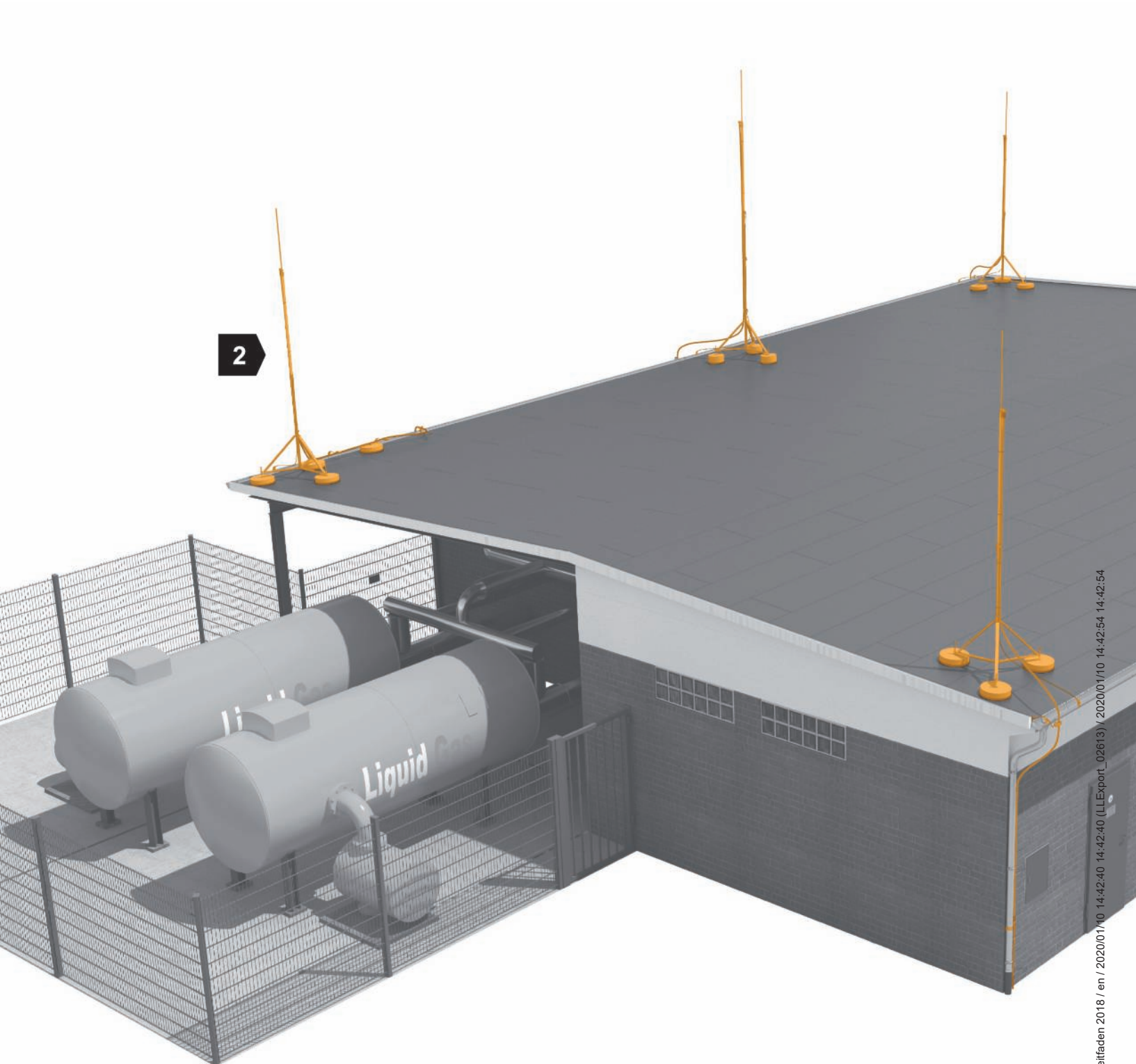

Installation principle for isCon® in potentially explosive areas

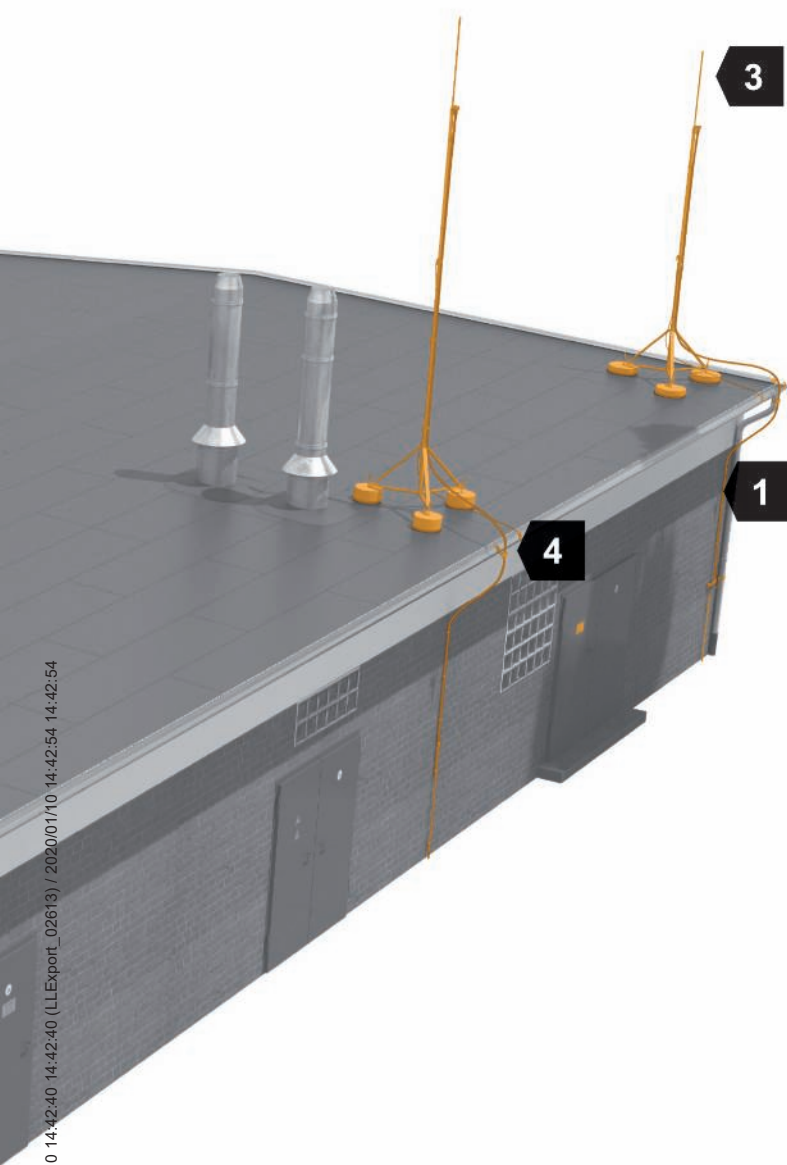

<b>1</b>	isCon® Professional + conductor
<b>2</b>	isFang air-termination rod 4 m with external isCon® conductor
<b>3</b>	isFang air-termination rod 6 m with external isCon® conductor
<b>4</b>	Potential connection

2.2.13.8 Selection aid, isCon® conductors

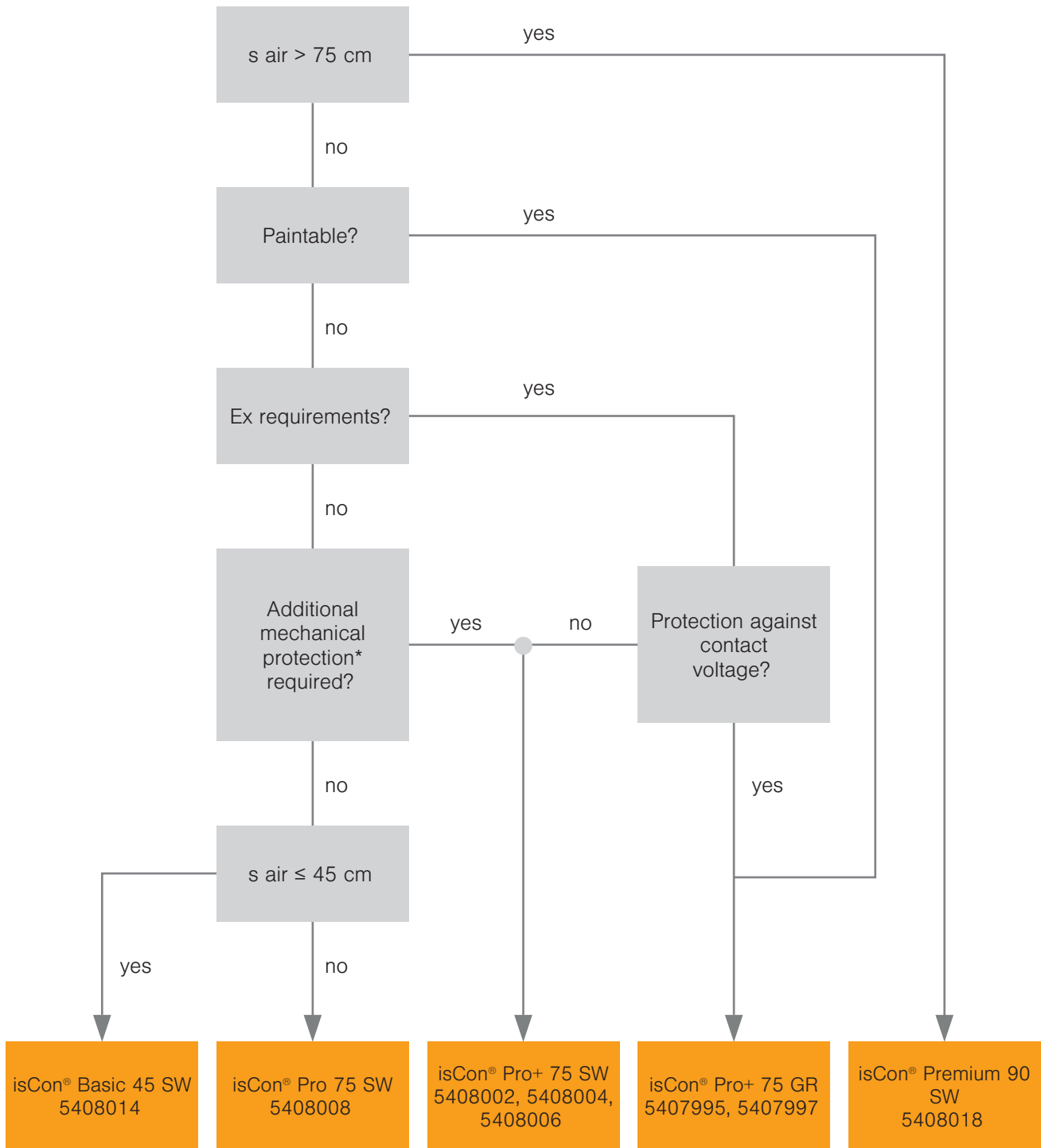

\*Additional mechanical protection: Surface damage of the external protective jacket does not influence the high-voltage-resistant, insulating function of the black isCon Pro+ conductor! For this, the jacketing must remain for a minimum of 0.2 mm over the entire scope of the conductor.



## 2.3 Lightning protection in potentially explosive areas

### 2.3.1 Basic principles

Every year, explosions endanger people and systems around the world. Any company manufacturing, processing or storing combustible substances must expect the risk of explosions.

#### Application examples:

- Gas pressure regulation and measurement systems
- Valve stations
- Pumping stations
- Fuel depots
- Natural gas storage facilities, natural gas compressor stations
- Petrol stations
- Refineries
- Biogas plants
- Production facilities of the chemicals and pharmaceuticals industry

Potentially explosive areas (Ex areas) are all those rooms and areas in which gases, vapours, mists or dusts, which can form potentially explosive mixtures with air, can collect to a hazardous level. Explosion protection will prevent damage to technical products, systems and other equipment. The system operator is responsible for the proper availability of the system!

#### Three factors must exist simultaneously for an explosion to occur:

- Combustible substance
- Oxygen
- Ignition source according to the Technical Rules for Operating Safety (TRBS) 2153/Technical Rules for Hazardous Substances (TRGS) 727: Static electricity, electromagnetic waves or lightning strike

Parts 1 and 2 of TRBS 2153 and 2152 have the same content as those of TRGS 720/721 and 722.



EN 1127-1 states, if lightning strikes a potentially explosive atmosphere, then the atmosphere is always ignited. The strong heating of the arresting paths of the lightning can also trigger ignition. Starting at the lightning strike point, strong currents flow, which can cause sparks close to the impact point. Even without a direct lightning strike, induced voltages can cause damage to electrical devices, systems and components for measurement, control and regulation (MCR) technology and, in the worst case, can lead to an explosion.

**For this reason, the three basic principles of explosion protection are:**

- Avoid potentially explosive atmospheres
- Avoid any possibly effective source of ignition
- Limit possible explosion impacts to a reasonable level

**Special requirements for lightning and surge protection in Ex areas**

The lightning protection measures must be created in such a way that there are no melting and spray impacts. In a lightning protection system erected according to IEC/EN 62305-3, the creation of ignitable sparks, as well as interfering or damaging impacts on electrical systems through the impact of lightning, need not be prevented in every case.

For this reason, when planning and running a lightning protection system through potentially explosive areas – so-called Ex zones – the following rules must additionally be taken into account:

- IEC/EN 62305-3 – Appendix D  
"Additional information for lightning protection systems for structure in potentially explosive areas"
- VDE 0185-305-3 – Supplement 2  
"Additional information for special building structures"

In Ex systems with Ex zone 2 and Ex zone 22, an Ex atmosphere will most likely only occur in rare, unforeseen circumstances. Therefore, it is possible to position air-termination systems in Ex zone 2 and Ex zone 22, taking Appendix D in IEC/EN 62305-3 into account.

With regard to the risk of ignition of a dangerous, potentially explosive atmosphere through a lightning strike, the Technical Rules for Hazardous Substances No. 509 refer to TRBS 2152 Part 3 Number 5.8. Appendix 1 of the TRGS lists individual details on the use and requirements of spark gaps in pipe lines, as well as detailed requirements on lightning and surge protection units according to IEC/EN 62305. Building sections containing tanks to store flammable liquids with an ignition point  $\leq 55$  °C and a volume of more than 3,000 litres must be protected against ignition risks from lightning strikes using suitable equipment. This also applies to above-ground tanks in the open air and underground tanks with flammable liquids with an ignition point of  $\leq 55$  °C, which are not completely surrounded by earth, masonry, concrete or multiples of these substances.

### 2.3.2 Assignment of the Ex zones

Potentially explosive areas are divided up into 3 zones according to the duration and frequency of the occurrence of potentially explosive atmospheres. These zones are always three-dimensional areas or a three-dimensional space.

A further subdivision of the potentially explosive areas makes a distinction between combustible gases and combustible dusts.

#### Intervals of the occurrence of potentially explosive atmospheres

Level of risk	Interval of occurrences of mixtures (annual)	Interval of occurrences of mixtures (differentiated)	Dwell times of the mixtures
Zone 0, Zone 20: Constant or frequent formation of potentially explosive atmospheres	Greater than for Zone 1, > 1.000x	Greater than for Zone 1, > 3x/day	Longer than for Zone 1
Zone 1, Zone 21: Occasional formation of potentially explosive atmospheres	≥ 10x, < 1.000x	≥ 1x/month, < 3x/day	Longer than 0.5 hrs, shorter than 10 hrs
Zone 2, Zone 22: Normally no or short formation of potentially explosive atmospheres	≥ 1x, < 10x	≥ 1x/year, < 1x/month	Shorter than 0.5 hrs

#### Definition of Ex zones

Ex zones	Description
Zone 0	In Zone 0, in normal operation, a dangerous, potentially explosive atmosphere can form over longer periods or at regular intervals as a mixture of air or combustible gases, vapours or mist.
Zone 1	In Zone 1, in normal operation, an atmosphere can occasionally form as a mixture of air or combustible gases, vapours or mist.
Zone 2	In Zone 2, in normal operation, a potentially explosive atmosphere can normally not, or only briefly, form as a mixture of air or combustible gases, vapours or mist.
Zone 20	In Zone 20, in normal operation, a dangerous, potentially explosive atmosphere can form over longer periods or at regular intervals in the form of a cloud of combustible dust contained in the air.
Zone 21	In Zone 21, in normal operation, a dangerous, potentially explosive atmosphere can form occasionally in the form of a cloud of combustible dust contained in the air.
Zone 22	In Zone 22, in normal operation, a dangerous, potentially explosive atmosphere can normally not, or only briefly, form in the form of a cloud of combustible dust contained in the air.

The operator of a building specifies the appropriate potentially explosive areas, divides them up into zones and labels them in a diagram of the systems to be protected according to the Ordinance on Industrial Safety and Health, and the Hazardous Substances Ordinance. For the planning of lightning protection measures, these drawings must be reviewed before the planning and erection of the lightning protection system. According to GefStoffV 2015, the operator is required to compile this explosion protection document.

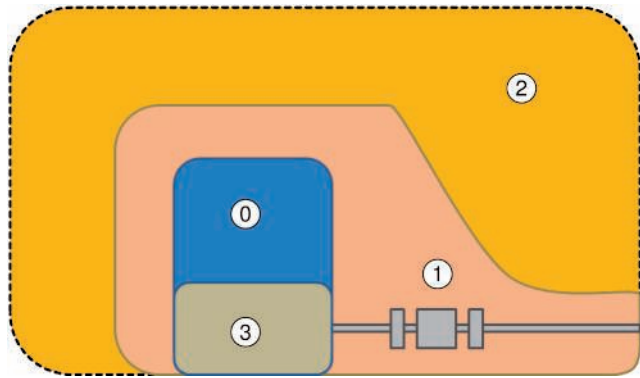

0	Zone 0
1	Zone 1
2	Zone 2
3	Combustible substance

Example of assignment into Ex zones

**Zone assignment of devices according to their category and/or protection level according to DIN EN 60079-14 (IEC 60079-14)**

Zone	Device category	Device protection level EPL
0	1G	Ga
1	2G	Gb
2	3G	Gc

Zone assignment example "gasses"

Electrical devices may be used in different zones, depending on the device protection level EPL and device category.

**ATEX guidelines**

The EU ATEX directives regulate the requirements resulting from the use of devices and protection systems in potentially explosive areas. Due to increasing international economic intermeshing, major progress has been achieved in the standardisation of the explosion protection regulations.

In the European Union, the preconditions for complete standardisation were created in the directives 2014/34/EU for manufacturers and 99/92/EC for operators. The manufacturers' directive 2014/34/EU (ATEX) regulates the requirements for the structure of explosion-protected devices and protection systems, by prescribing basic health and safety requirements.

Manufacturers of components for potentially explosive areas must obtain an approval for their products. The quality requirements for the production of resources without effective sources of ignition is very high. An approved test office will only certify the function of the components of a manufacturer after a comprehensive test, and will assign them into categories according to failure safety. In addition, the testing offices use regular audits with the manufacturers to ensure continuously guaranteed product quality.



### 2.3.3 Solutions

#### Equipotential bonding systems

Systems in potentially explosive areas require equipotential bonding according to IEC 60079-14. All the bodies of electrically conductive parts must be connected to the equipotential bonding system. Secure equipotential bonding connections against self-loosening according to IEC 60079-14 and the Technical Rules for Operating Safety (TRBS) 2152 Part 3.

According to TRBS 2152 Part 3 and IEC/EN 62305-3, the arresting paths of the lightning must be created in such a way that heating or ignitable sparks or spray sparks cannot become the ignition source of a potentially explosive atmosphere. OBO can offer innovative solutions for this.

Areas of application could include:

- Chemicals industry
- Paint shops
- Oil and gas industry
- Fuel depots
- Gas pressure regulation and measurement systems (GDRM systems)
- Liquefied gas storage containers
- Balance pits and large outdoor filling systems
- Filling and emptying points (e.g. Big-Bag sacking, balances, sack handover)

Supplementary Sheet 2 (IEC 62305-3) requires that connections of lightning protection systems in potentially explosive areas are created in such a way that no ignitable sparks are created when the lightning current passes through.

The EX PAS equipotential busbar (equipotential busbar for potentially explosive areas) is used for lightning protection equipotential bonding according to IEC 62305-3 and protective/functional equipotential bonding according to DIN VDE 0100 Part 410/540.

The lack of ignition sparks in an explosive atmosphere has been tested according to IEC/EN 62561-1 according to the most demanding explosion group, IIC, with a potentially explosive gas mixture and a lightning current of up to 75 kA. It can thus be used in all explosion groups, even in the explosion groups IIB and IIA. As the EX PAS equipotential busbar does not possess its own potential source of ignition, it does not come under the European Directive 2014/34/EU.

The EX PAS equipotential busbar is tested according to IEC/EN 62561-1 in Class H for high loads and is suitable for indoor and outdoor applications.

Thanks to the patented design, the equipotential busbar can be used in a system according to IEC 60079-14 and IEC/EN 62305-3 in the Ex zones 1/21 and Ex zones 2/22. The EX PAS represents the current state of the art for equipotential busbars in Ex areas.

#### The EX PAS equipotential busbar for potentially explosive areas possesses the following properties:

- Suitable for all explosion groups and use in Ex zones 1/21 and 2/22
- Free of ignition sparks with a lightning current of up to 75 kA
- Tested according to Class H for high loads
- Screws protected against self-loosening
- Made from corrosion-resistant material (stainless steel)
- Manufacturer and article labelling permanently attached

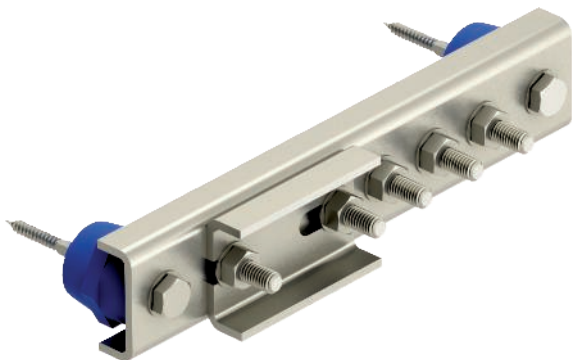

Equipotential busbar for zone 1/21 and 2/22 – EX PAS



Strip Earthing clamp for Zone 1/21 and 2/22 EX BES



Spark gap mounted on insulating sections

### Ex spark gaps – EX ISG H

According to TRGS 507, electrical separating elements in potentially explosive areas must be bridged with spark gaps. The spark gaps must have a response surge voltage of 50% of the testing AC voltage of the insulating elements, although with a maximum of 2.5 kV.

The ATEX-certified OBO EX ISG H spark gap insulates the parts of the system against corrosion currents, fulfilling the requirements for the connection of lightning currents in potentially explosive areas according to IEC/EN 62561-3.

To avoid arcing to insulating pieces in Ex areas, the use of Ex-certified spark gaps is required.



Spark gap EX ISG H

The OBO EX ISG H spark gap is certified according to the following directives for Zone 1/21 and 2/22:

- ATEX
- IECEx

## Selection of spark gaps in potentially explosive areas

Spark gaps	Item no.	EX labelling
EX ISG H 350	5240031	ATEX Ex II 2 G Ex db IIC T6 Gb Ex II 2 D Ex tb IIIC T80 °C Db
EX ISG H	5240030	
EX ISG H 350 2L	5240032	

### OBO Ex spark gaps

As soon as the EX ISG H responds and conducts, the lightning current  $I_{imp}$  of up to 100 kA is run to the earth along a defined route. This arresting operation only takes a few microseconds. After the arresting operation, the EX ISG H returns to a standard, high-resistance state. The EX ISG H is low maintenance, as it is designed for a wide range of arresting operations.

Flanges and insulating pieces show a relatively low voltage resistance, which is usually in the range of a few kV. Class 1 insulating flanges have a testing AC voltage of  $U_{PW}$  of 5 kV and class 2 insulating flanges of 2.5 kV. In so doing, the technical rules GW 24 of DVGW require selection of the response surge voltage  $U_{as}$  of the spark gaps in such a way as to be  $0.5 \times U_{PW}$ . Thus, the OBO Ex spark gap, with an  $U_{rimp}$  of  $\leq 1.25$  kV, fulfils the requirements for all insulating flange classes according to IEC 62561-3. The same requirements are made in the European recommendation of Ceocor (European Committee for the study of corrosion and protection of pipes and pipeline systems).

When the spark gap has ignited, the pulse current causes a voltage drop  $U_L$  via the connection cables and the spark gap, whereby the connection technology has the greatest influence. Here, the maximum voltage drop should be smaller than the peak values of the testing AC voltage  $\hat{U}_{PW}$ . Class 1 insulating flanges have approx. 7 kV as the peak value.

Besides the response range, the EX ISG H has a defined lower blocking range. Interfering earth currents or close parallel high-voltage routes can, for example, induce permanent 50 Hz AC voltages into the pipeline segments. To prevent the EX ISG H from igniting every time – and, in consequence, influencing the KKS system (cathodic corrosion protection system) – a so-called 50 Hz withstand AC voltage  $U_{WAC}$  is defined and must be maintained. Here, DVGW GW 24 recommends:  $\leq 250$  V, 50 Hz. This safety-relevant requirement is fulfilled by the OBO Ex spark gap.

The AfK recommendation no. 5 of the DVGB e.V. working group (German Technical and Scientific Association for Gas and Water) explains the coordinated use of Ex spark gaps on insulating flanges using examples and detailed calculations.

### Product characteristics of the spark gap EX ISG H

The EX ISG H implements state-of-the-art technologies and innovations:

- Solvent-free, environmentally friendly material
- Modern machining technology from the automotive sector
- Chemical resistance
- Resistance to oils and extreme temperature variations
- Halogen-free
- UV-stable, weatherproof
- Ignition protection type/device protection level: Pressure-resistant encapsulation/"db" for gases, protection through housing/"td" for dusts
- Resistant to salt water
- Highest testing Class H in accordance with IEC 62561-3
- Tested connection technology Class H according to IEC 62561-1
- Suitable for all explosion groups and use in Ex zones 1/21 and 2/22

**External lightning protection with high-voltage-resistant, insulated conductor**

The OBO isCon® conductor prevents direct arcing between the conductor and the building to be protected. After the first potential connection behind the connection element, the isCon® conductor reflects an equivalent separation distance ( $s_e$ ) of up to 0.75 metres in the air and up to 1.5 metres in solid substances according to IEC/EN 62305-3. This means that installation is possible directly on metallic and electrical structures.

The OBO isCon® Pro+ conductor has been tested independently according to the following directives:

- ATEX

OBO manufacturer's declarations can be found at [www.obo-bettermann.com](http://www.obo-bettermann.com).

In Ex zones 1 and 21, after the first potential connection, the OBO isCon® Pro+ conductor should be connected at regular distances (0.5 metres) using a metallic cable bracket (e.g. isCon H VA or PAE) to the equipotential bonding. If there is a lightning strike, the equipotential bonding must not carry lightning current and must be in the protection angle of the lightning protection system.



isCon® conductor on air-termination rod in Ex area

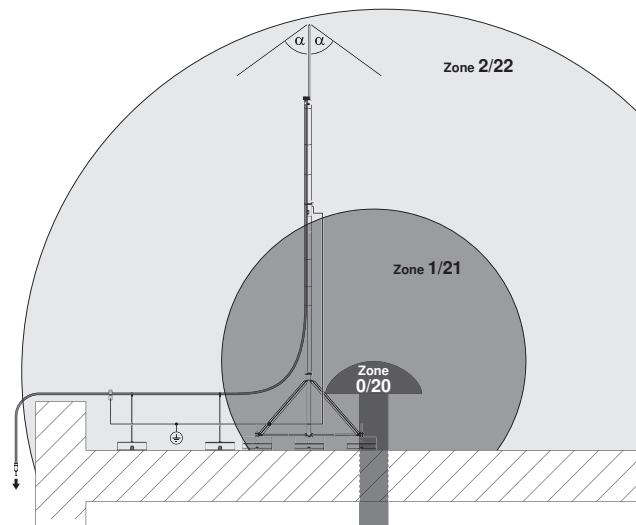

Example of the installation of the isCon® Pro+ system in the Ex zones of a potentially explosive area

**Earthing systems**

In potentially explosive areas, type B according to IEC/EN 62305-3 is recommended for earthing systems. In this special application, the arresting resistance must be as low as possible and may not reach 10 Ohm. With the "Earthing systems" module, the OBO Construct online tool makes efficient support available for project planning and documentation of type B (ring and foundation earthers) and type A (earth rods) earthing systems.



*Installing a foundation earth electrode*

## 2.4 Earthing systems

The standards specify that each system must include an earthing system.

### **What do we mean by an "earthing system"?**

We can find the required definitions in IEC 60050-826 – Low-voltage electrical installations: Terms.

- "Totality of the electrical connections and equipment used to earth a network, a system or a resource." Also:
- "Conductive element, embedded in the earth or in another specific conductive medium in electrical contact with the earth."

### **The tasks of an earthing system are:**

- Arresting of the lightning current into the earth
- Equipotential bonding between the down-conductors
- Equipotential bonding near conductive walls of the building structure

### **Consequences of an improperly created earthing system:**

- Dangerous surge voltages at the equipotential bonding
- No even potential course on the earthing system
- Destruction of the foundation through insufficient arresting area of the energy-rich lightning current
- Destruction of the foundation through improperly made connections (no terminal connection)
- Electrical decoupling of high amounts of lightning energy

### 2.4.1 Basic principles

The earthing system is the basis for the safe function of every electrical system and its protection devices. It ensures operation and protects people against hazardous currents. Buildings with IT systems and data cabling have high requirements for electromagnetic compatibility measures (EMC). To ensure the EMC shield and personal protection, a meshed equipotential bonding and a low-ohmic earthing system integrated in the structure are required.

### 2.4.2 Normative requirements

The earthing system creates the electrical connection to the surrounding earth. The earthing resistance of the system should be as small as possible (less than 10  $\Omega$ ) and must be coordinated with further protective measures and switch-off conditions.

The equipotential bonding based on the earthing system fulfils the following functions:

- Protection against electric shock – IEC 60364-4-41
- Protective equipotential bonding – IEC 60364-5-54
- Lightning protection equipotential bonding – IEC 62305
- Energy systems and surge protection – IEC 60364-4-44
- Low-voltage electrical installations – IEC 60364-5-54
- Data cabling and shielding – EN 50310
- Electromagnetic compatibility – EMC Directive 2004/108/EC (EMVG)
- Antenna earthing – IEC 60728
- Application of equipotential bonding and earthing in buildings with information technology equipment – EN 50310
- Electrical installations in residential buildings – DIN 18015-1
- Foundation earth electrodes – DIN 18014

In Germany, the foundation earth electrode in new buildings must meet the requirements of DIN 18014 and the technical connection conditions (TAB) of the power supply generator (VNB).

### Note

Section 542.1.1 of IEC 60364-5-54: "For protection and function purposes, earthing systems may be used together or separately, according to the requirements of the electrical system. The protection requirements must always have priority."

The earthing system thus represents a safety-relevant part, and installation is only permitted if performed by an electrical or lightning protection specialist. In addition, the responsible specialist must be stated in the prescribed documentation.

The following infringements of the rules of technology are specified in § 319 "Causing danger during construction work" of the German Criminal Code:

1. Whosoever, in the planning, management or execution of the construction or the demolition of a structure, violates generally accepted engineering standards and thereby endangers the life or limb of another person shall be liable to imprisonment not exceeding five years or a fine.
2. Whosoever, in engaging in a profession or trade, violates generally accepted engineering standards in the planning, management or execution of a project to install technical fixtures in a structure or to modify installed fixtures of this nature and thereby endangers the life or limb of another person shall incur the same penalty.
3. Whosoever causes the danger negligently, shall be liable to imprisonment not exceeding three years or a fine
4. Whosoever, in cases under subsections (1) and (2) above, acts negligently and causes the danger negligently shall be liable to imprisonment not exceeding two years or a fine.

The earthing system is a part of the electrical system. Only electrical or lightning protection specialists may install, check and accept the earthing system. Construction companies must allow the supervision of the installation and acceptance of the earthing system by electrical and lightning protection specialists.

**Type A**

- Horizontal earth electrodes
- Vertical earth electrodes (earth rods)

**Type B**

- Ring earth electrodes (surface earthers)
- Foundation earth electrodes

External and internal lightning protection systems

**2.4.3 Planning methods**

IEC 62305-3 demands continuous lightning protection equipotential bonding. This means individual earthing systems must be connected together to create a global earthing system.

The standard differentiates between type A and type B earthing systems. Type A earth electrodes are vertical or horizontal earthers (earth rods). Type B earth electrodes are any surface earther (ring earthers, foundation earthers). OBO Construct for earthing systems offers digital support in the planning of earthing systems.

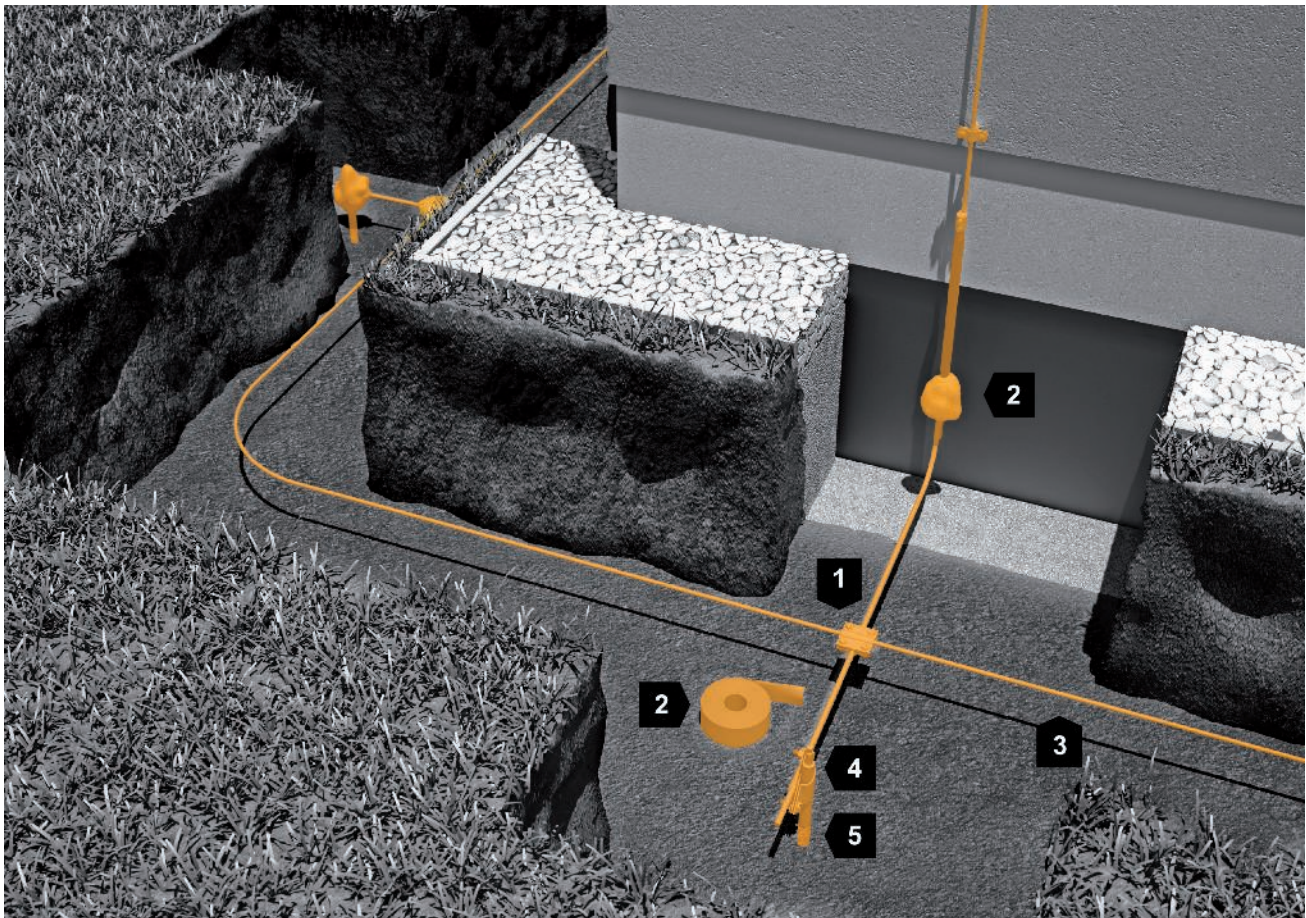

1	Cross-connector
2	Corrosion protection strip
3	Round conductor
4	Connection clips
5	Earth rods (observe corrosion protection for connectors)

Type A earth rods with ring equipotential bonding

### 2.4.3.1 Type A earth rod structure

#### Functional method

As single earth electrodes, an earth rod of 9.0 m in length is recommended for each conductor. This should be routed at a distance of 1.0 m from the foundation of the building and min. 0.5 m below the surface of the earth or under the frost limit.

As a minimum dimension (according to IEC 62305-3), a length of 2.5 m for vertical routing and 5 m for horizontal routing apply for type A earthers for lightning protection classes III and IV. Depending on the soil conditions, earth rods can be driven into the earth by hand or using suitable electric, petrol or pneumatic hammers.

All earth rods must be connected with a ring earther inside or outside of the building and with an entry to the equipotential busbar.

#### Information on arrangement of type A earthers

- In general, earth rods are inserted vertically into the earth to fairly large depths. They are driven into natural soil, which is usually only found beneath foundations.
- Often, the specific ground resistance cannot be determined in the densely built-up areas. In these cases, when determining the minimum length of the earther, it is sufficient to assume a specific ground resistance of 1,000 Ohm/m.
- In type A earthing systems, there is a minimum requirement of two earth rods.
- Earther arrangement, type A: connection inside and outside the building structure.
- Down-conductors are interconnected near the surface of the ground.

*The required earther lengths may be split into several lengths connected in parallel.*

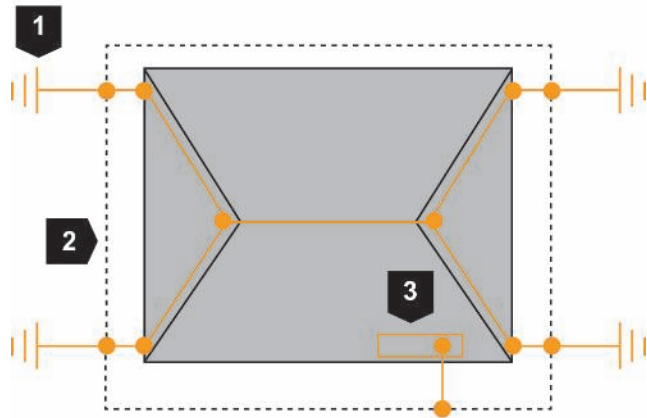

1	Earth rod, type A
2	Underground connection
3	Main earthing rail (MER)

*Earthing system, type A: Connection outside the building structure*

The type A fan or earth rods do not fulfil the requirements for equipotential bonding and potential control. A type A earthing system is suitable for low building structures (e.g. single-occupancy dwellings), existing building structures, for LPS with air-termination rods or tension cables, or for an isolated LPS. Type A earthing systems comprise horizontal and vertical earth electrodes, connected to each conductor.



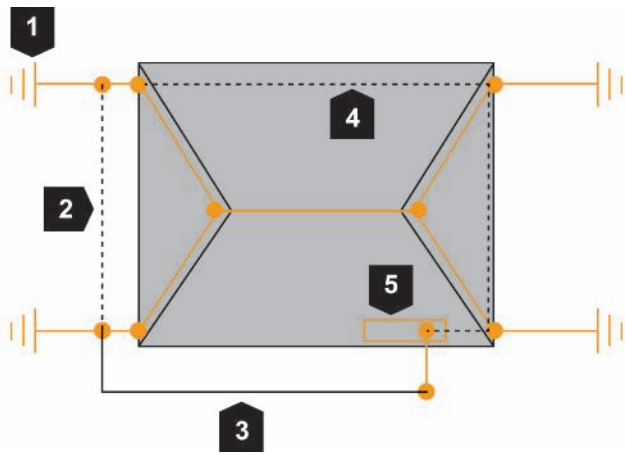

1	Earth rod, type A
2	Underground connection
3	Surface-mounted connection
4	Connection inside the building
5	Main earthing rail (MER)

Earthing system, type A: Connection inside and outside the structure

If it is not possible to connect the earth rods in the ground, this can take place in or on the building.

Connection cables should be as short as possible and not installed higher than 1 m above the ground. If the lightning protection equipotential bonding was only connected to a single earth electrode, then high potential difference to other earthers would result. This could cause unapproved arcing or lethal voltage differences.

The minimum length of each earth electrode – based on the protection class of the LPS – is not relevant if the earthing resistance of the individual earth electrode is  $\leq 10 \Omega$  (recommendation). The minimum length of each earth rod is  $l_1$  for horizontal earth electrodes and  $0.5 \times l_1$  for vertical earth electrodes.

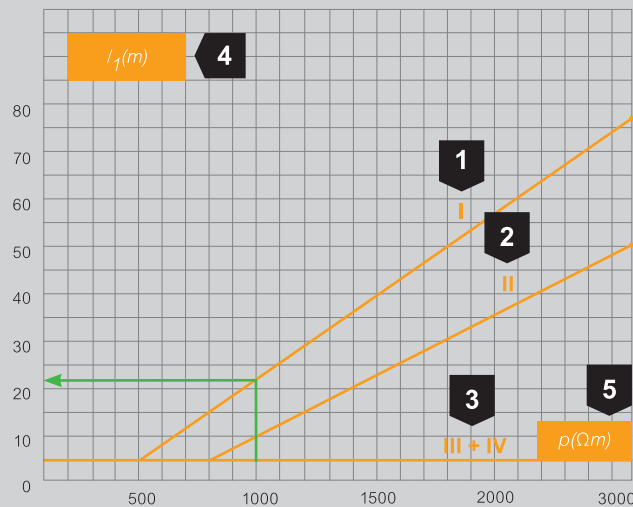

1	Lightning protection class I
2	Lightning protection class II
3	Lightning protection class III + IV
4	Minimum earth rod length $l_1$ (m)
5	Specific earth resistance $p$ ( $\Omega m$ )

Minimum lengths of earthers

**Example**

- Lightning protection class I
- Sand, gravel, top layers (dry) 1,000  $\Omega m$

**Result**

- Lightning protection class 1: 22 m
- Earth rod: 11 m

### Materials for type A

The following materials can be used, amongst others:

- Rods from stainless steel, Ø 20 mm
- Galvanised steel rods, Ø 20 mm
- Copper coated steel rods, Ø 20 mm
- Stainless steel rods, Ø 25 mm
- Galvanised steel flat conductors, 30 x 3.5 mm
- Stainless steel flat conductors, 30 x 3.5 mm
- Galvanised steel pipes, Ø 25 mm

See Chapter 2.7.2 Materials for earthing systems.

### Corrosion protection

In potentially corrosive areas, rust-proof stainless steel with a molybdenum content of  $\geq 2\%$ , e.g. 1.4404 or 1.4571, should be used. Detachable connections in the ground must be protected against corrosion (plastic corrosion protection strip).

### Normative requirements

All types of earth rods and potential coupling pieces must be tested according to IEC 62561-2 ED2.

#### 2.4.3.2 Type B ring earth electrodes

The type B ring earth electrodes is laid around the building.

### Functional method

Outside the building, at least 80% of the ring earth electrodes (surface earther's) overall length must be in contact with the ground. It must be installed as a closed ring at a distance of 1.0 m and a depth of 0.5 m (or 0.8 m according to DIN 18014) around the external foundation of the building. A ring earth electrode is an earther according to arrangement type B.

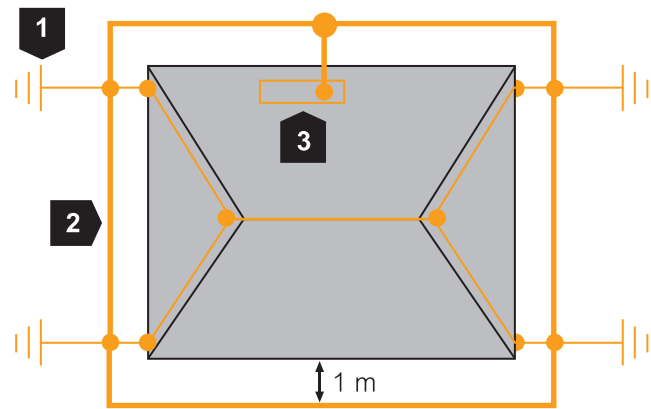

1	Earth rods (optional)
2	Underground connection
3	Main earthing busbar (MEB)

Installation principle, ring earther

### Materials for ring earth electrodes

The following materials can be used, amongst others:

- Stainless steel flat conductors, 30 x 3.5 mm
- Galvanised steel flat conductors, 30 x 3.5 mm
- Round conductors made of copper, Ø 8 mm
- Round conductors made of stainless steel, Ø 10 mm
- Round conductors made of galvanised steel, Ø 10 mm

See Chapter 2.7.2 Materials for earthing systems.

### Corrosion protection

In the earth, rustproof stainless steel with a molybdenum content of  $\geq 2\%$ , e.g. 1.4404 or 1.4571, should be used. Detachable connections in the ground must be protected against corrosion (plastic corrosion protection strip).

### Condition for additional earthing measures

With type B earthing systems, the central radius  $r$  must be greater than or equal to the minimum earthing length  $l_1$ .

$$r = \sqrt{A/\pi}$$

$$r \geq l_1$$

$r$ : Medium radius of the area covered by the earther

$A$ : Area of the earthing system in  $m^2$

$l_1$ : Minimum earth length in m

### Example

Area of  $100 m^2$ , covered by a type B earther

Lightning protection class I,

Sand, gravel, top layers (dry)  $1,000 \Omega m$ ,

$l_1$  from "Minimum lengths of earthers" = 22 m

Result:

$$A = 100 m^2$$

$$r = \sqrt{(100m^2/\pi)} = 31.83 m$$

$$31.83 m \geq 22 m$$

Condition  $r \geq l_1$  fulfilled.

*In the earth, rustproof stainless steel with a molybdenum content of  $\geq 2\%$  should be used.*

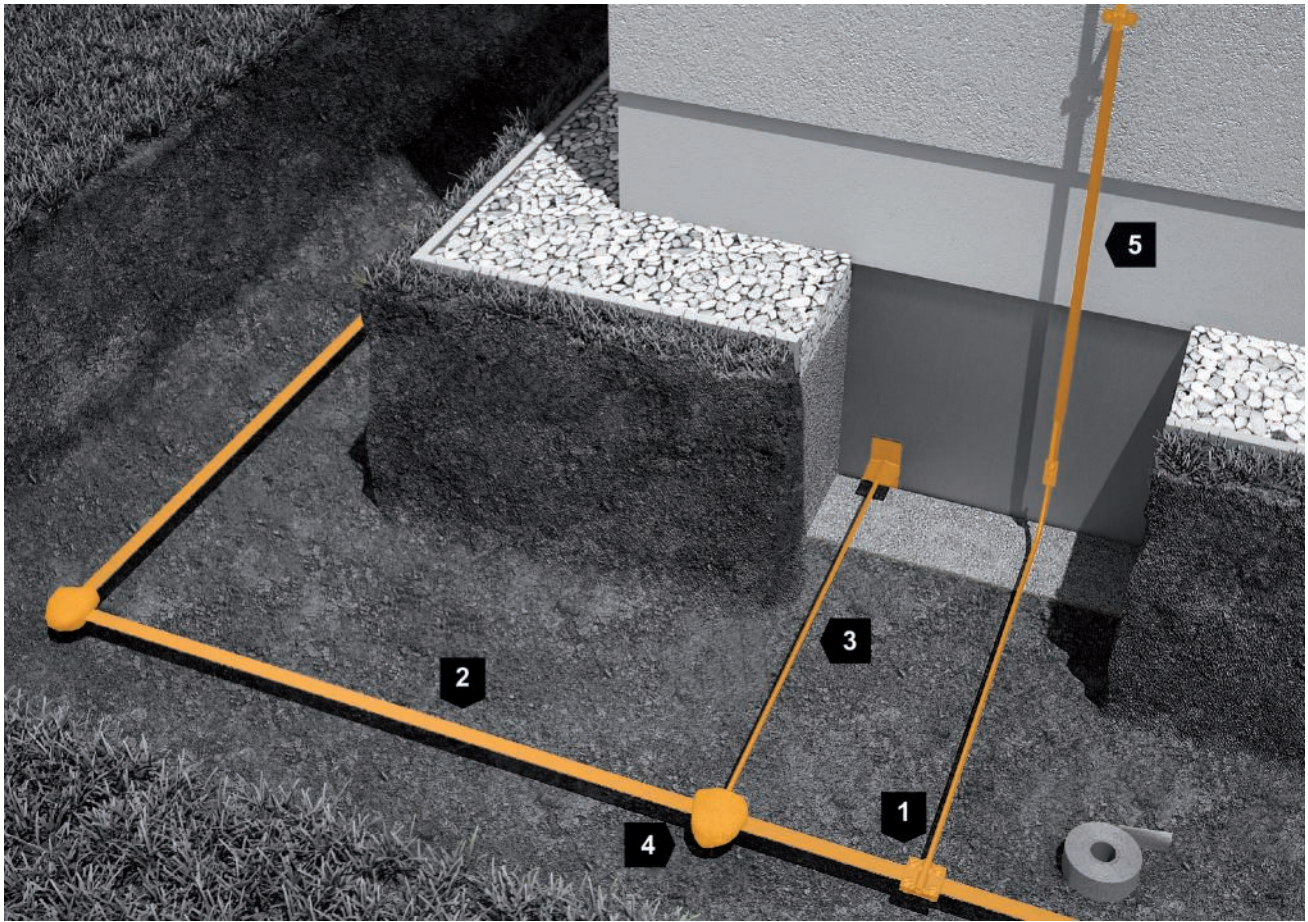

<b>1</b>	Cross-connector
<b>2</b>	Flat conductor
<b>3</b>	Round conductor
<b>4</b>	Corrosion protection strip
<b>5</b>	Earth lead-in rod

*Type B ring earth electrode*

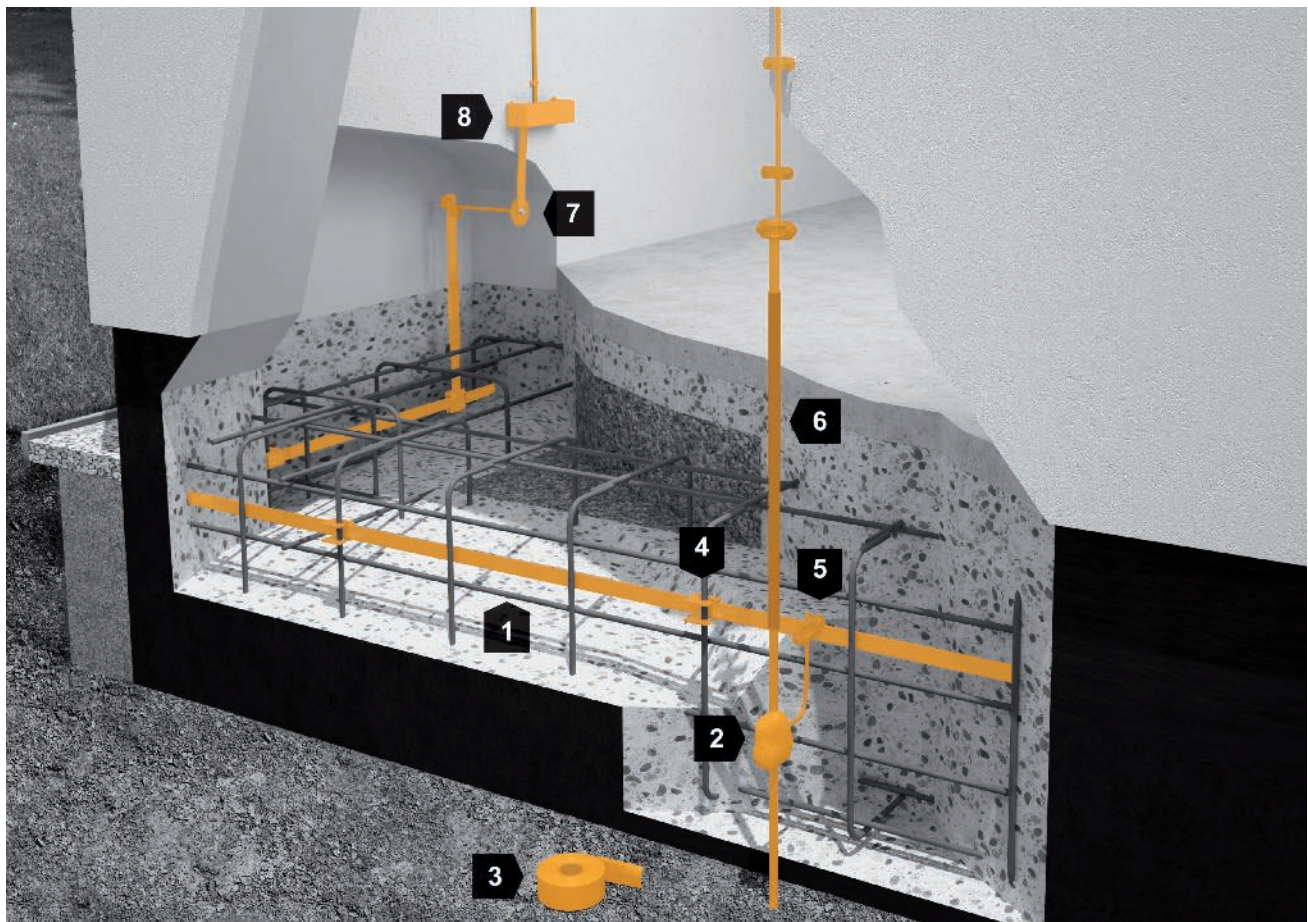

1	Flat conductor
2	Cross-connector with corrosion protection
3	Corrosion protection strip
4	Connection terminal for reinforced steels
5	Cross-connector
6	Earth lead-in rod
7	Earthing fixed point
8	Main earthing busbar (MEB)

Type B foundation earth electrode

### 2.4.3.3 Type B foundation earth electrodes

The foundation earth electrodes is a component of the electrical installation of the building.

### Functional method

A foundation earth electrodes is an earther that is embedded into the concrete foundation of a building. It also acts as a lightning protection earth electrodes if the lugs required for connecting the conductors protrude from the foundation. The steel strip is to be connected to reinforcements at intervals of approx. 2 m. DIN 18014 forms the basis for constructing the foundation earth electrodes. Wedge connectors must not be used in mechanically compacted concrete.

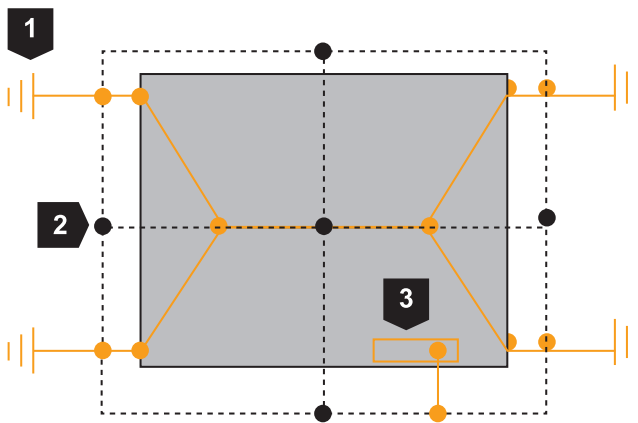

1	Earth rods (optional)
2	Ring earth electrodes
3	Main earthing busbar(MEB)

*Installation principle, foundation earther with functional equipotential bonding cable*

In order to achieve a clean insertion, the use of strip holders is recommended for the installation of foundation earth electrodes. The holders must be inserted at a distance of approx. 2 m.

In accordance with DIN 18014, connect the foundation earthers of each individual foundation on the lowest storey into a closed ring. If necessary, insert transverse conductors, in order to create a grid of 20 x 20 m. If the earth electrodes do not have the necessary contact with the earth electrodes in the foundation, then a grid ring earther should additionally be installed. The foundation earth electrodes becomes a functional equipotential bonding conductor.

#### This is the case when using:

- Water-impervious concrete according to DIN EN 206 and DIN 1045-2 (white trough)
- Bitumen seals (black trough), e.g. bitumen lines
- Polymer-modified bitumen thick coating
- Impact-resistant plastic webs
- Heat insulation (perimeter insulation) on the underside and side walls of the foundations
- Additionally attached, capillary breaking, poorly electrically conductive earth strata, e.g. made of recycling or crushed glass

For further information, see Chapter 2.4.4.4.

This grid ring earther must be connected with the functional equipotential bonding conductor and must be executed as follows either outside of or within the floor plate:

- Grid width of 10 x 10 m with lightning protection measures
- Grid width of 20 x 20 m without lightning protection measures

#### Materials for foundation earthers and functional equipotential bonding conductors

The following materials can be used, amongst others:

- Galvanised steel flat conductors, 30 x 3.5 mm
- Stainless steel flat conductors, 30 x 3.5 mm
- Copper cable, 50 mm<sup>2</sup>
- Round conductors made of galvanised steel, Ø 10 mm
- Round conductors made of stainless steel, Ø 10 mm

#### Connection lugs

Connection lugs must be made of materials with permanent corrosion protection. Either hot galvanised steels with plastic jacketing or rustproof stainless steels with a molybdenum content  $\geq 2\%$  must be used, e.g. 1.4404 or 1.4571. The connection lugs should be clearly marked with protective caps during the construction phase, e.g. with the OBO ProtectionBall.

#### Materials for ring earthers

The following materials can be used for the grid ring earther:

- Stainless steel flat conductors, 30 x 3.5 mm
- Round conductors made of stainless steel, Ø 10 mm
- Copper cable, 50 mm<sup>2</sup>



*OBO ProtectionBall (item no. 5018 01 4) for marking earthing lugs*

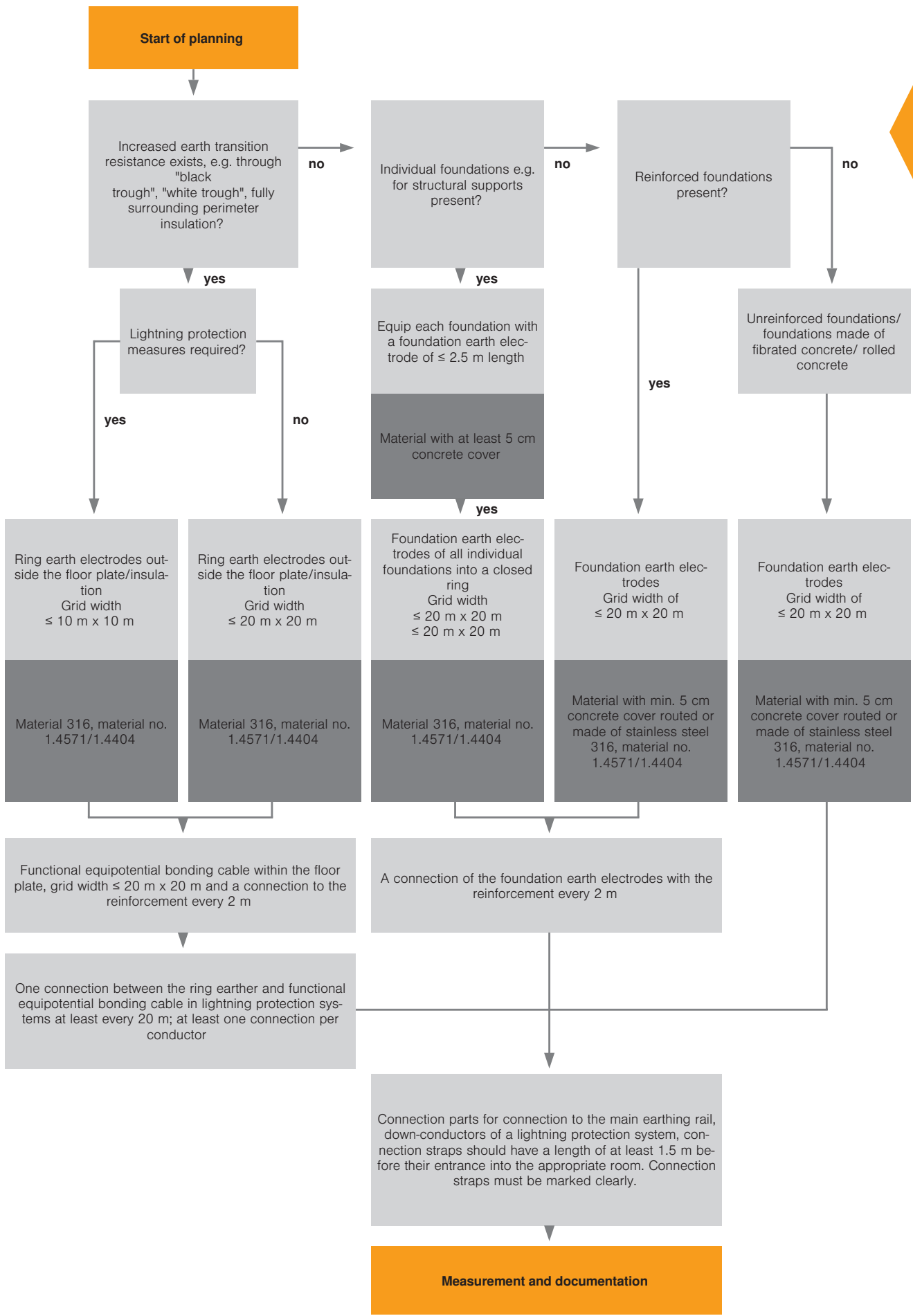

TBS Blitzschutz-Leitfaden 2018 / en / 2020/01/10 14:42:40 (LLExpert\_02613) / 2020/01/10 14:42:54 14:42:54

*The planning aid can be used to determine grid widths and versions for the foundation earthing system for individual projects.*



*Wall penetration sealed against pressurised water DW RD10, item no. 2360 04 1*

### Connecting parts

If connections are made in the earth, e.g. in the case of the ring earther, these must be implemented in such a way that they are permanently resistant to corrosion. It is recommended that stainless steel with a molybdenum content of  $\geq 2\%$ , e.g. 1.4404 or 1.4571, is used. These connectors must additionally be fitted with a corrosion protection strip.

Connections between foundation earthers/functional equipotential bonding cables and the reinforcement, or between functional equipotential bonding cables and the ring earther, and with the connection lugs, can take the form of bolted joints, clamped joints or welded joints. Tying wire is not acceptable. Only tested connection components in accordance with DIN EN 62561-1 (IEC 62561-1) may be used.

Connections from the ring earther into the building should be located above the maximum groundwater level. Alternatively, wall penetrations sealed against pressurised water (type DW RD10) should be used.

### Corrosion protection

Inside sealing troughs and in contact with perimeter insulation (DIN 18014) and in potentially corrosive areas, rustproof stainless steel with a molybdenum content of  $\geq 2\%$ , e.g. 1.4404 or 1.4571, must always be used. Detachable connections in the ground must be protected against corrosion (plastic corrosion protection strip).

### 2.4.4 Versions

Earthing systems can consist of either a type A or a type B earther. Different versions of each are available, to suit different application situations.

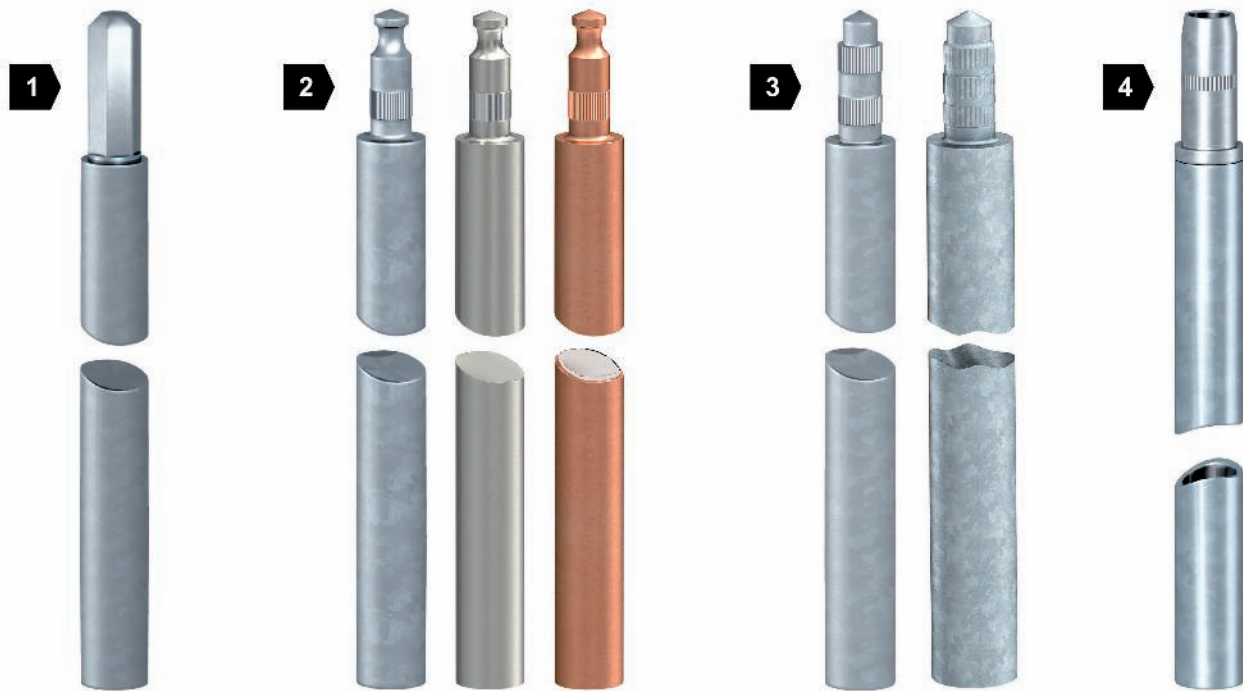

<b>1</b>	Type: OMEX
<b>2</b>	Type: BP
<b>3</b>	Type: Standard
<b>4</b>	Type: LightEarth

Earth rod versions

#### 2.4.4.1 Earth rods

Earth rods are differentiated according to the type of connection of the individual earth rods, the external diameter and the material.

Earth rods consist of combinable individual rods of length 1.5 m. The connection is made using a coupling consisting of a hole and stud. This has the advantage that the coupling closes automatically at the time of installation and creates a secure connection from both a mechanical and an electrical point of view. When an earth rod is driven in, this compacts the ground around it. This is conducive to a good electrical contact.

Striking tools are generally used for driving in the earth rods. The possible penetration depth of the earth rods depends on various geological factors.

You can find more information on the selection and accessories in the current installation manual for earth rods from OBO.

*As earth rods enter soil strata of constant moisture and temperature, this produces constant resistance values.*



### 2.4.4.2 Black trough

The black trough is a bitumen or plastic seal surrounding the structure on all sides in the area in which it is in contact with the earth. Because the foundation earthen no longer has contact with the earth here, an additional grid ring earthen must be created. A functional equipotential bonding cable must be created in the foundation. Connection lugs must be routed into the building in such a way that they are resistant to pressurised water or above the maximum groundwater level.

### 2.4.4.3 White trough

The white trough is a construction consisting of water-impermeable concrete, i.e. water cannot penetrate right through the concrete. Because the foundation earthen no longer has contact with the earth here, an additional ring earthen must be created. Concrete of grades such as C20/25 or C25/30 is considered water-impermeable concrete.

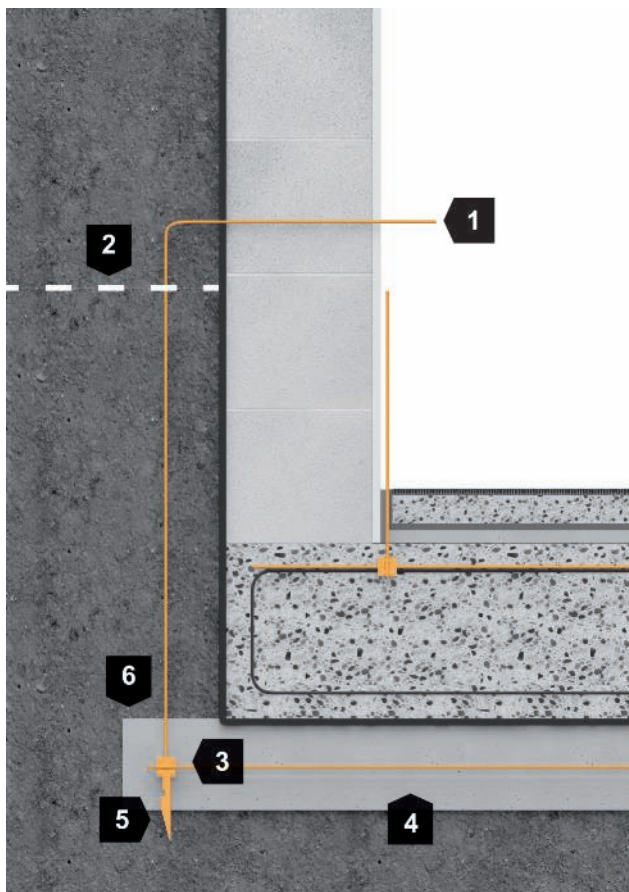

1	Connection lug, min. 1.50 m
2	Maximum groundwater level
3	Ring earth electrode
4	Blinding layer
5	Spacer
6	Min. 5 cm concrete cladding is used as corrosion protection

Black trough

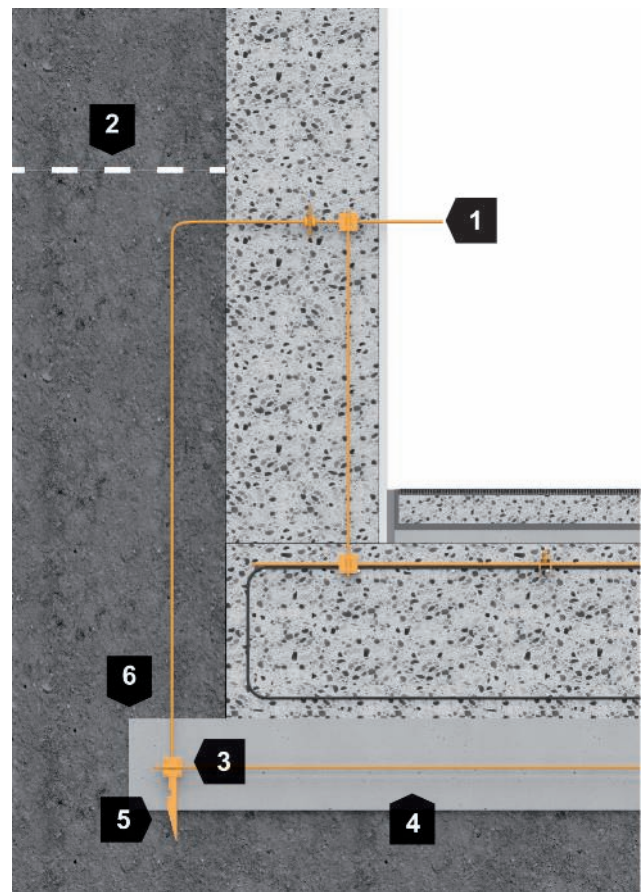

1	Connection lug, min. 1.50 m
2	Maximum groundwater level
3	Ring earth electrode
4	Blinding layer
5	Spacer
6	Min. 5 cm concrete cladding is used as corrosion protection

White trough

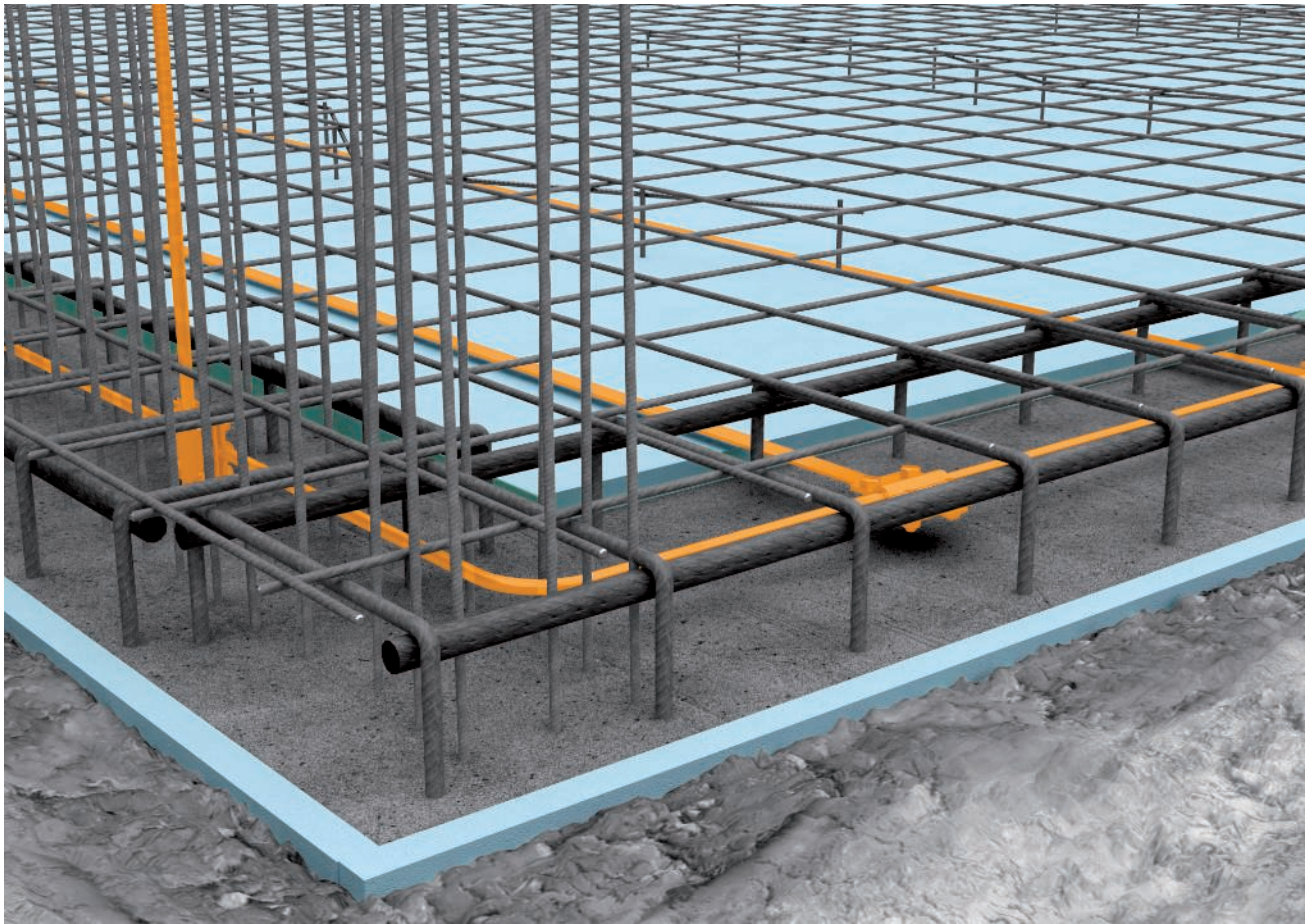

*Insulated floor plate (perimeter insulation, shown here in blue)*

#### 2.4.4.4 Perimeter insulation

Perimeter insulation is heat insulation, which surrounds the area of the structure in contact with the earth from outside. It often consists of polyurethane foam sheets or crushed glass.

If the building structure is surrounded on all sides by perimeter insulation, i.e. all surrounding walls, strip foundations and the bottom of the foundation, the function of the foundation earther is no longer fulfilled.

Because the foundation earther no longer has contact with the earth here, an additional grid ring earther must be created. A functional equipotential bonding cable must be created in the foundation. Connection lugs must be routed into the building in such a way that they are resistant to pressurised water or above the maximum groundwater level.

If the perimeter insulation is only on the surrounding walls, earther contact is often still intact. The foundation earther can be implemented in the concrete.

To ensure contact with the earth, water-impermeable concrete must not be used.

If the exterior walls and the foundation plate are surrounded with perimeter insulation, the earthing in the floor plate still has some earthing effect if the strip foundation is open at the bottom.

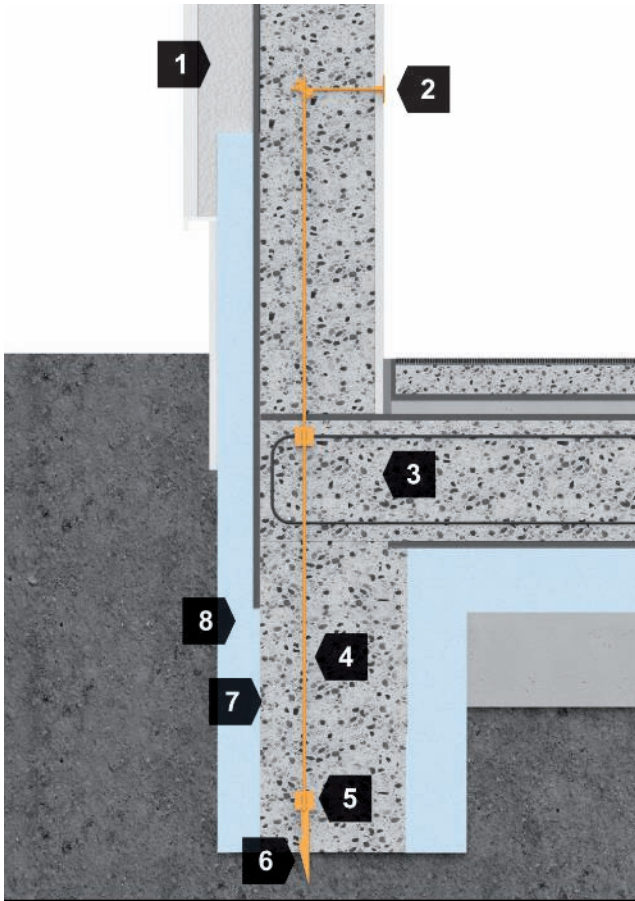

<b>1</b>	Insulation
<b>2</b>	Earthing fixed point
<b>3</b>	Reinforced floor plate
<b>4</b>	Strip foundation
<b>5</b>	Foundation earth electrode
<b>6</b>	Spacer
<b>7</b>	Min. 5 cm concrete cladding is used as corrosion protection
<b>8</b>	Perimeter insulation

*Perimeter insulation to the side of and beneath the foundation plate*

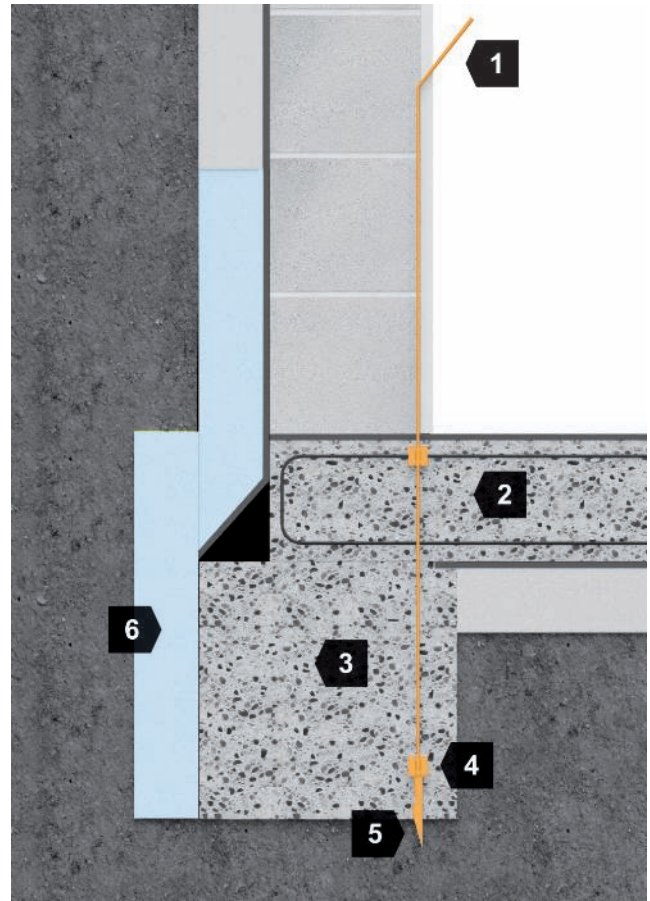

<b>1</b>	Connection lug, min. 1.50 m
<b>2</b>	Floor plate
<b>3</b>	Strip foundation
<b>4</b>	Foundation earth electrode
<b>5</b>	Spacer
<b>6</b>	Perimeter insulation

*Perimeter insulation only on the surrounding walls*

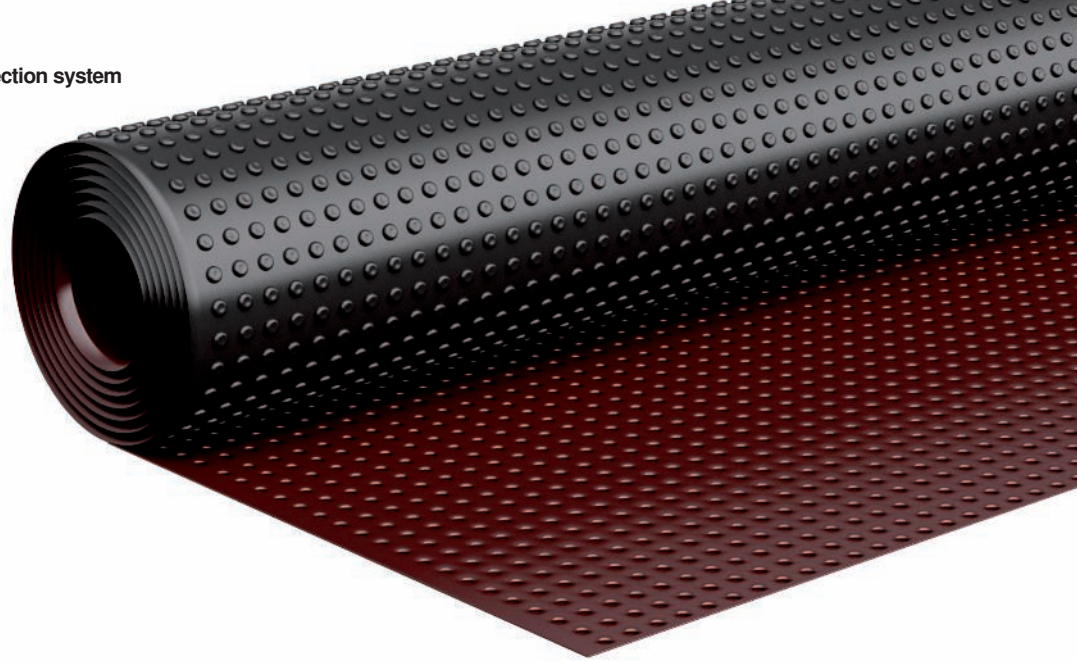

Example: studded plastic strips

### Influence of plastic films on the earthing resistance

Generally there is a negative influence between the strip foundation or foundation plate and the earth in this area.

#### "Simple" films:

- With simple films, the foundation earthing effect is limited.
- However, earthing resistance is usually still sufficient. The foundation earthing is effective as an earthing in the strip foundation or in the foundation plate.

### Studded plastic strips

- Made of special, high-density polyethylene. If the individual membranes overlap, the earth contact of the foundation earthing is impaired.
- Further studded strips on the exterior walls produce a very strong electrical insulating effect. In this case the earth contact of the foundation earthing is no longer intact.

Because the foundation earthing no longer has contact with the earth here, an additional grid ring earthing must be created.

### 2.4.5 OBO selection aid for foundation and ring earthers according to DIN 18014 and IEC/EN 62305-3

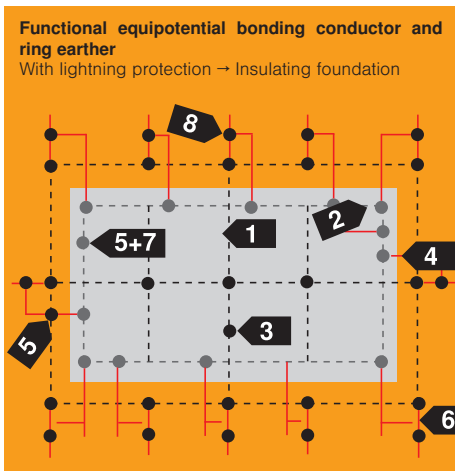
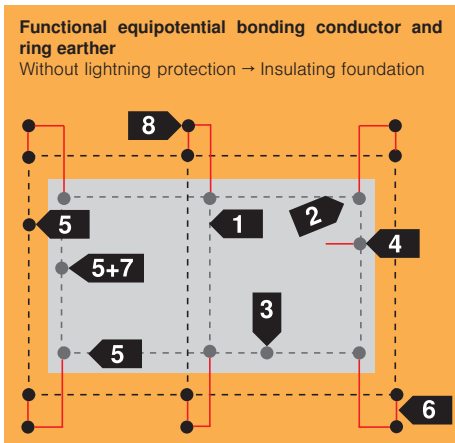
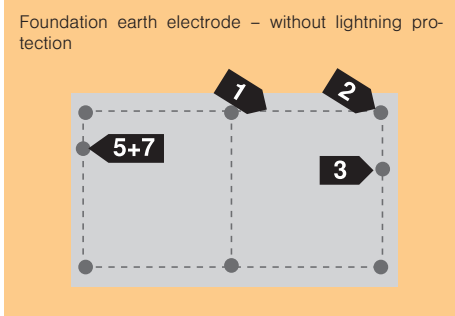

#### Earthing material, for use in concrete

- Surrounded by min. 5 cm of concrete on all sides; ≤ 2 m connect to reinforcement
- Grid width max. 20 x 20 m; with EMC protection to VDE 0185-305-4: 5 x 5 m
- Unreinforced foundation: Material no. 1.4571/1.4404, V4A

	Type	PU	Item no.	Description
1	5052	60 m	5019347	Strip steel 30 x 3.5 mm FT
	1811 I	25 units	5014026	Spacer 400 mm FT
2	250 A-FT	25 units	5313015	Connector, strip steel with reinforcement FT
3	1814 FT	25 units	5014468	Terminal on reinforcement to Ø 14 mm
	1814 FT D37	25 units	5014469	For reinforcements Ø 16–37 mm
4	205 B-M10 VA	25 units	5420008	Earthing fixed point M10
	DW RD 10	10 units	2360041	Sealing sleeve for round conductors 10 mm
	5011 VA M10	50 units	5334934	End piece for earthing fixed point M10
8	ProtectionBall	25 units	5018014	Protective cap for connection straps

#### Earthing and connection material, for use in the earth or cleanliness layer

- Material no. 1.4571/ 1.4404, V4A; clamps in earth with corrosion protection strip
- Min. 0.8 m deep, routing outside drainage shaft, frost apron (moist area)
- Grid: Without lightning protection: 20 x 20 m, connection between earth and concrete: Every 20 m, with lightning protection: 10 x 10 m, connection between earth and concrete: Every conductor

	Type	PU	Item no.	Description
5	RD 10 V4A	60 m	5021642	Round conductor Ø10 mm V4A
	5052 V4A 30x3.5	25 m	5018730	Strip steel 30 x 3.5 mm V4A
6	250 V4A	25 units	5312925	Terminal for round conductor and strip steel
	356	10 m	2360101	Corrosion protection strip, width: 100 mm

#### Material for equipotential bonding

	Type	PU	Item no.	Description
7	1801 VDE	1 unit	5015650	Equipotential busbar, industrial
	1809	1 unit	5015073	Equipotential busbar, residential

#### Foundation earth electrode:



**Insulation foundation when:**

- WU concrete (white trough) for WZ<0.6, from C30/B35, (from C25/B30) → Already possible
- Black/brown trough
- Completely enclosed foundation with perimeter insulation or dimpled membranes
- Additionally attached, capillary-breaking, poorly electrically conductive earth strata, e.g. made of recycling

#### Ring earther:

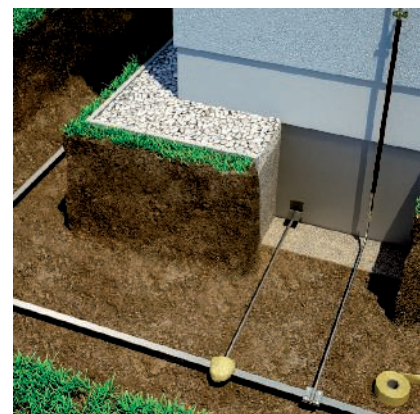

## OBO Construct planning aids

### Digital selection aids for earthing systems and surge protection

The OBO Construct electronic planning aids are programs developed to support electrical installation engineers and planners in the design of electrical installation systems. In particular, in complex areas such as surge protection and earthing, there are countless technical and standard general conditions to be observed. The two OBO Construct programs for earthing and surge protection systems should provide active help here. Systematic questions simplify the search for suitable products and guaranteed surge protection systems and earthing systems which fulfil the standards.

### OBO Construct for surge protection

This online tool aids you in the project-orientated selection and connection of suitable surge protection systems and provides you with information on the OBO surge protection systems. You can create your personal materials list, connection diagram and invitation to tender texts quickly, efficiently and in a targeted manner for complete surge protection in the fields of energy technology, photovoltaics, telecommunication, MSR, TV, HF and data technology. The result can be exported easily into Excel format for further processing.

### OBO Construct for earthing systems

The digital selection aid can be used for the easy planning and configuration of earthing systems. The simple and intuitive user guidance leads you through the individual components of the earthing system step by step. The software then automatically calculates the amounts required and the matching accessories. The application can be opened on any end device irrespective of its operating system – be it smartphone, tablet or desktop PC.

## Benefits

- Time and place-independent work assistance
- Transmit planning requirements to complete product systems
- Find suitable products quickly and simply
- Calculate material and parts lists automatically
- Download configuration results as Excel or Word files



## 2.6 Potential control

The potential control reduces the step voltage close to rods or down conductors on a building. Additional earth conducts are laid and connected with one another in a grid format.

The lightning current is distributed through the metal grid system and the voltage drop and the resulting step voltage are reduced. As the distance from the rod or down-conductor increases, the depth of the earther cable also increases (in increments of 0.5 m). The earthers are typically laid 3 m apart.

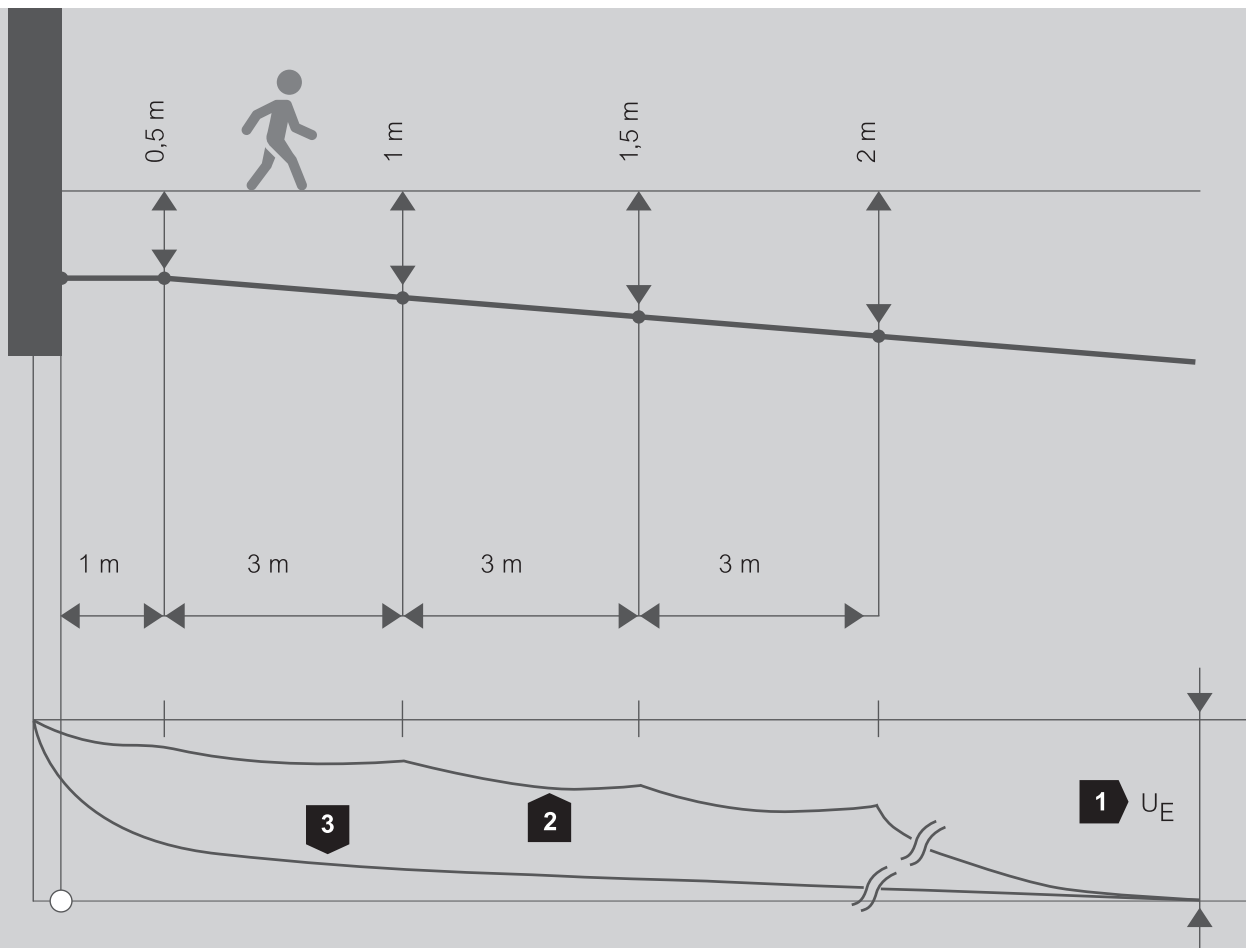

<b>1</b>	Earthing voltage $U_E$
<b>2</b>	With potential control
<b>3</b>	Without potential control

Potential control on a street-light pole

### 2.6.1 Step voltage

The step voltage is the voltage between a person's feet placed 1 m apart. Here the current flows between the person's feet through their body. The contact voltage is the voltage between a component (e.g. the conductor) and earth potential.

Here the current flows from the hand to the foot through the body. Both types of voltage can be harmful to the body. These voltages need to be reduced via potential control or insulation.

### 2.6.2 Protection against dangerous touch voltage

The isCon® conductor Pro+ 75 GR can be used as protection against dangerous touch voltage. This is particularly required in areas with groups of people. The isCon® conductor Pro+ 75 GR was tested up to a length of max. 5 m with a pulse voltage of min. 100 kV (1.2/50  $\mu$ s) in rain and fulfils the requirements for touch protection according to IEC/EN 62305-3.

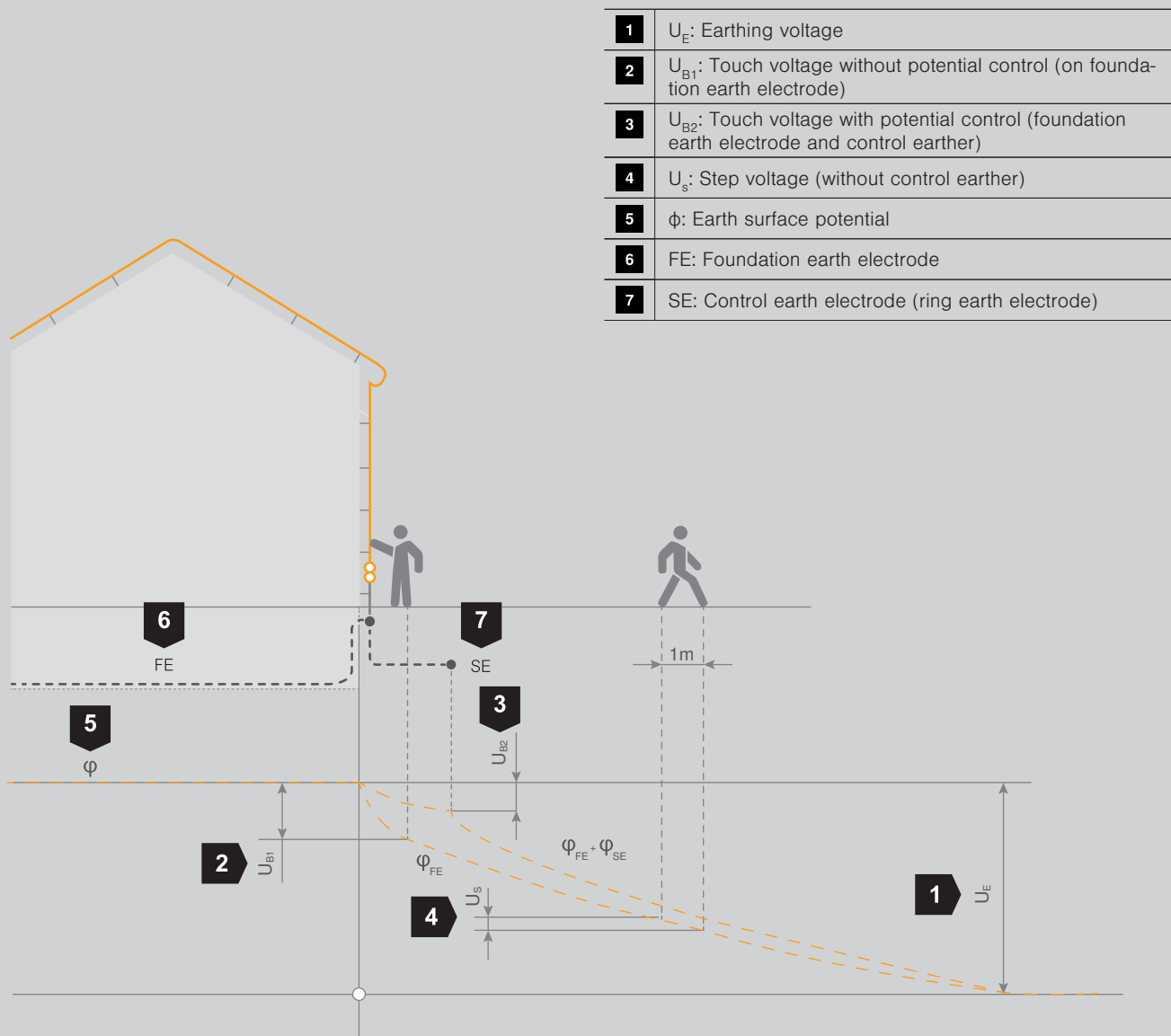

Electrical potential on the earth surface and voltages as current passes through the foundation earth electrode (FE) and control earther (SE)



## 2.7 Materials and corrosion protection

The following materials are preferred for use in external lightning protection systems: Hot galvanised steel, rustproof steel, copper and aluminium. All metals in direct contact with the ground or water can corrode due to stray current or aggressive soils. Corrosion is when a metal material reacts with its surroundings to the detriment of the material's properties.

### Causes of corrosion

Corrosion occurs when different metals are connected with one another in soil, water or molten salt, e.g. aluminium round conductors as arrestors and copper/steel as earthing material. It can also occur when a single type of metal is embedded in two distinct environments, e.g. steel in earth and concrete.

*The minimum cross-sections, shape and material depend on the appropriate application.*

Material	Form	Minimum dimensions
Copper, tin-plated copper	Strip solid	20 x 2.5 mm
	Round, solid (b)	Ø 8 mm
	Cable (b)	50 mm <sup>2</sup>
	Round, solid	Ø 15 mm
Aluminium	Round, solid	Ø 8 mm
	Cable	50 mm <sup>2</sup>
Copper-coated aluminium alloy	Round, solid (c)	Ø 8 mm
Aluminium alloy	Strip solid	20 x 2.5 mm
	Round, solid	Ø 8 mm
	Cable (b)	50 mm <sup>2</sup>
	Round, solid	Ø 15 mm
Hot galvanised steel	Strip solid	20 x 2.5 mm
	Round, solid	Ø 8 mm
	Cable (b)	50 mm <sup>2</sup>
	Round, solid	Ø 15 mm
Copper-coated steel (c)	Round, solid	Ø 8 mm
	Strip solid	20 x 2.5 mm
Rustproof steel (a)	Strip solid	20 x 2.5 mm
	Round, solid	Ø 8 mm
	Cable (b)	50 mm <sup>2</sup>
	Round, solid (d)	Ø 15 mm

(a) Chromium ≥ 16%; Nickel ≥ 8%; Carbon ≤ 0.08%

(b) Diameter of 8 mm can in certain applications be reduced to 28 mm<sup>2</sup> (diameter 6 mm) if mechanical resistance is not a primary criterion.

(c) At least 70 µm copper plating with 99.9% copper content

(d) Can be used for air-termination rods and base

Table 2.27: Material, form and minimum dimensions of air-termination cables, air-termination rods, earth entry rods and conductors

### 2.7.1 Materials for air-termination and conductor systems

The following materials are preferred for use in external lightning protection systems: Hot galvanised steel, rustproof steel, copper and aluminium.

#### Corrosion

A risk of corrosion occurs especially when joining different material types. For this reason, no copper parts may be installed above galvanised surfaces or above aluminium parts as copper particles worn away by rain or other environmental influences can penetrate the galvanised surface. In addition, a galvanic element is created, which accelerates corrosion of the contact surface. If a connection between two different materials that are not recommended to be joined is required, bi-metal connectors can be used.

The following figure shows the use of bimetal connectors on a copper gutter to which an aluminium round conductor is attached. Points at increased risk of corrosion, such as insertion points into the concrete or soil, must be corrosion-protected. A suitable coating must be applied as corrosion protection to connection points in the ground.



*Variable bi-metal quick connector with bi-metal intermediate plate (copper/aluminium)*

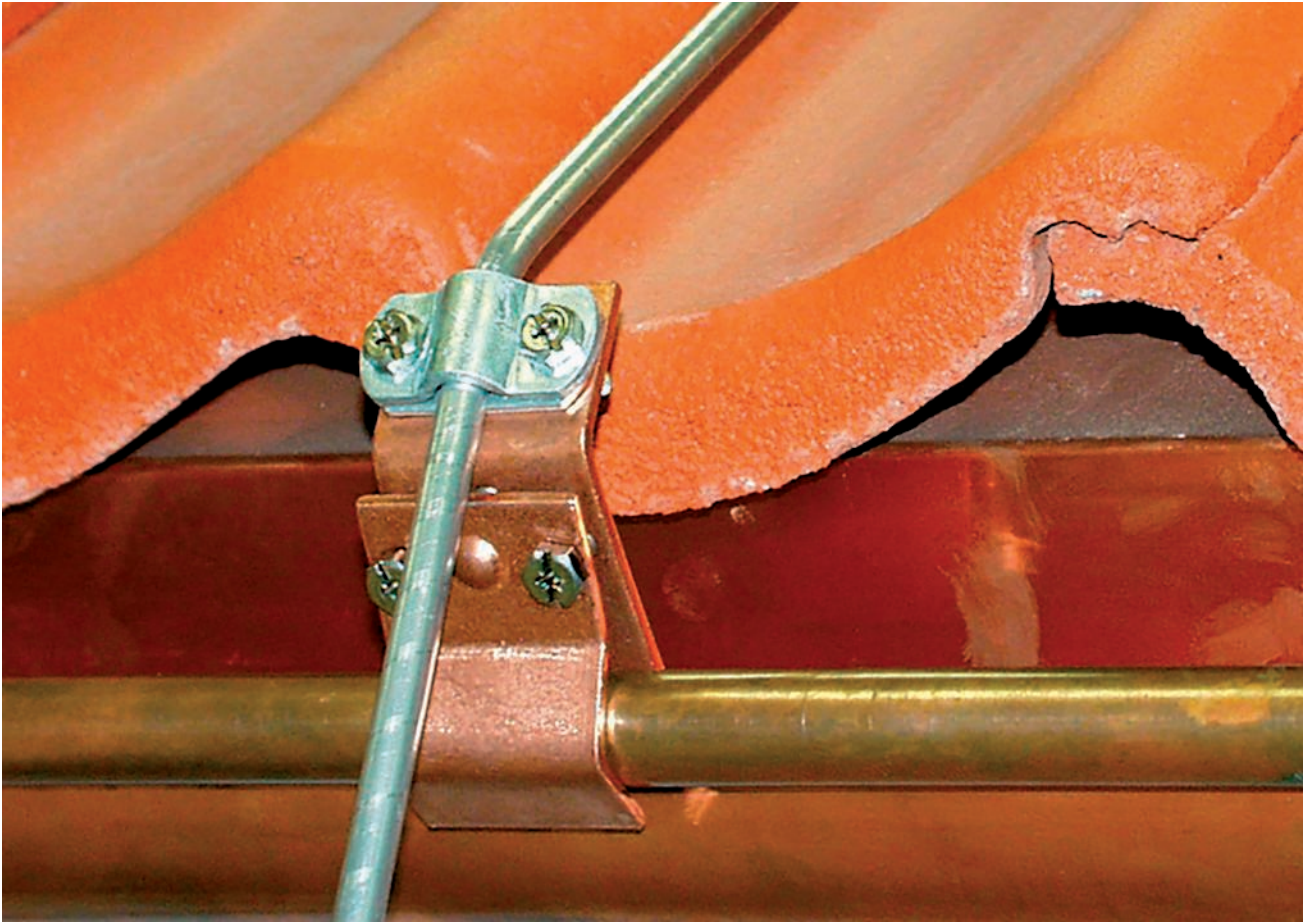

Bi-metal roof gutter clamp (aluminium round conductor and copper roof gutter)

Aluminium must not be placed directly (without a distance) on, in or under plaster, mortar or concrete or in the earth. Table 2.28, "Material combinations" evaluates possible metal combinations with regard to contact corrosion in air.

	Steel, galvanised	Aluminium	Copper	Stainless steel	Titanium	Tin
Steel, galvanised	Yes	Yes	No	Yes	Yes	Yes
Aluminium	Yes	Yes	No	Yes	Yes	Yes
Copper	No	nein	Yes	Yes	No	Yes
Stainless steel	Yes	Yes	Yes	Yes	Yes	Yes
Titanium	Yes	Yes	No	Yes	Yes	Yes
Tin	Yes	Yes	Yes	Yes	Yes	Yes

Table 2.28: Permitted material combinations (no = increased corrosion)

*The minimum cross-sections, shape and material depend on the client's application.*

**2.7.2 Materials for earthing systems**

Material	Form	Minimum dimensions		
		Earth rod	Earth conductor	Earth plates
<b>Copper Tin plated copper</b>	Cable		50 mm <sup>2</sup>	
	Round, solid		Ø 8 mm	
	Strip, solid		20 x 2.5 mm	
	Round, solid	Ø 15 mm		
	Pipe	Ø 20 mm		
	Solid sheet			500 x 500 mm
	Grid mesh			600 x 600 mm
<b>Hot galvanised steel</b>	Round, solid		Ø 10 mm	
	Round, solid	Ø 14 mm		
	Pipe	Ø 25 mm		
	Strip, solid		30 x 3 mm	
	Solid sheet			500 x 500 mm
	Grid mesh			600 x 600 mm
	Profile (a)	290 mm <sup>2</sup>		
<b>Bright steel (b)</b>	Cable	Ø 8 mm	70 mm <sup>2</sup>	
	Round, solid		Ø 10 mm	
	Strip, solid		25 x 3 mm	
<b>Copper-coated steel</b>	Round, solid (c)	Ø 14 mm		
	Round, solid (c)		Ø 8 mm	
	Round, solid (d)		Ø 10 mm	
	Strip, solid		30 x 3 mm	
<b>Rustproof steel (e)</b>	Round, solid		Ø 10 mm	
	Round, solid	Ø 15 mm		
	Strip, solid		30 x 3.5 mm	

- (a) Various profiles with a cross-section of 290 mm<sup>2</sup> and a minimum thickness of 3 mm are permitted, e.g. cross profiles
- (b) Must be embedded in concrete to a depth of at least 50 mm
- (c) With at least 250 µm copper support with 99.99% copper content
- (d) With at least 70 µm copper support with 99.99% copper content
- (e) Chromium ≥ 16%; nickel ≥ 5%; molybdenum ≥ 2%; carbon ≤ 0.08%

Table 2.29: Materials, forms and cross-sections of earthers according to IEC 62561-2



BET lightning current generator and BET test mark

## 2.8 Testing of lightning protection system components

### Connection components

Components for lightning protection systems are tested for functionality according to IEC/EN 62561-1 – Requirements for connection components. After a conditioning phase lasting 10 days, the components are impacted with three lightning strikes. The lightning protection components for air-termination systems are tested with  $3 \times I_{imp}$  100 kA (10/350). This corresponds to test class H.

Components for conductors along which the lightning current can spread (at least two conductors) and connections in the earthing system are tested with  $3 \times I_{imp}$  50 kA (10/350). This corresponds to test class N.

### Earth rods and conductor material

All types of earth rods and their couplings for lightning protection must be tested according to IEC/EN 62561-2. Here, they must withstand numerous load tests according to conditioning that represents artificial ageing. Mechanical tests, lightning current tests and compliance with the material-specific tensile strength are some examples here. The standardised specifications regarding tensile strength, corrosion resistance and the minimum product dimensions for conductor material must be tested, depending on the material and product type, and complied with (see also Table 2.27 and 2.29). Additional short-circuit current tests with 50 Hz currents prove the use for the earthing of power installations exceeding 1 kV a.c. according to EN 50522.

Testing standard	Tested with	Application
IEC TS 62561-8	$3 I_{imp}$ 200 kA (10/350)	High-voltage-resistant, insulated isCon® Premium conductor, including terminals and air-termination device
IEC 62561-1	$3 I_{imp}$ 100 kA (10/350)	Air-termination system
IEC 62561-1	$3 I_{imp}$ 50 kA (10/350)	Multiple (at least two) conductors, along which the lightning current can spread.

Table 2.30: Test classes of connecting components

# 3

The lightning protection equipotential bonding represents internal lightning protection in the building. When lightning strikes, a voltage drop occurs at the earthing resistor, producing dangerous voltage differences between the metal building components and the power and data cables, which need to be prevented. The equipotential bonding connects together all metal installations (gas and water pipes, etc.), electrical systems (power and data cables), the lightning protection system and the earthing system, either directly or via lightning current arresters (SPD type 1 or type 1+2). Surge protection devices (SPDs) can guarantee a voltage limitation according to the insulation coordination.

The lightning current arrestors (SPD type 1 or type 1+2) should ideally be located directly at the point of entry or supply point of the structure. This ensures that no lightning current is diverted into the installation that could disrupt electrical systems. Surge protection devices (SPD type 2) must be placed downstream of the combination arrestors (SPD type 1+2) at the supply point or the lightning current arrestors (SPD type 1) to protect the electronic devices. These SPDs reduce the surge voltage to a very low protection level that devices and the installation can withstand.

According to the new IEC/EN standards  
**IEC 60364-4-44**  
**IEC 60364-5-53**  
surge protection has been  
mandatory since 2016.



## Chapter 3: The internal lightning protection system

3.	The internal lightning protection system	176
3.1	Equipotential bonding systems	177
3.1.1	Planning methods	177
3.1.2	Versions	179
3.1.2.1	Industrial applications	180
3.1.2.2	Residential and office buildings	180
3.1.2.3	Potentially explosive areas	181
3.2	Surge protection systems for energy systems	182
3.2.1	Lightning discharges	182
3.2.1.1	Switching operations (SEMP)	183
3.2.1.2	Electrostatic discharge (ESD)	183
3.2.2	Types of surge voltage	183
3.2.2.1	Transient surge voltages	183
3.2.2.2	Temporary and permanent surge voltages	183
3.2.3	Planning methods	183
3.2.3.1	Lightning protection zone concept	184
3.2.3.2	Type classes of surge protection devices	185
3.2.3.3	Protection devices in various power supply systems	187
3.2.3.4	Selection criteria	189
3.2.3.5	Installation requirements	195
3.2.3.6	Protection circuit	200
3.2.4	Versions	200
3.2.4.1	Installation (RCD)	200
3.2.4.2	Wind power plants	201
3.2.4.3	Residential and industrial applications	202
3.2.4.4	PV systems	202
3.2.4.5	LED street lighting systems	211
3.2.4.6	LED interior lighting	214
3.3	Surge protection systems for data and information technology	216
3.3.1	Planning methods	216
3.3.1.1	Topologies	218
3.3.1.2	Interference in information technology systems	219
3.3.1.3	Building and area shielding	224
3.3.1.4	Cable shielding	225
3.3.1.5	Transmission characteristics	229
3.3.1.6	Symmetrical and asymmetrical data transfer	233
3.3.1.7	Device protection classes	233
3.3.2	Installation of data cable protection devices	236
3.3.2.1	Equipotential bonding of data cables	236
3.3.2.2	Measurement and control technology	237
3.3.2.3	Telecommunications	240
3.3.2.4	High-frequency technology	244
3.3.2.5	Data technology	250

### 3. The internal lightning protection system

Our dependency on electrical and electronic equipment continues to increase, in both our professional and private lives. Data networks in companies or emergency facilities such as hospitals and fire stations are lifelines for an essential real time information exchange. Sensitive databases, e.g. in banks or media publishers, need reliable transmission paths.

It is not only lightning strikes that pose a latent threat to these systems. Ever more frequently, today's electronic devices are damaged by surge voltages caused by remote lightning discharges or switching operations in large electrical systems.

#### Surge protection through equipotential bonding

If electrical devices are subjected to a high potential difference or surge voltage, then the insulation or the voltage resistance may be exceeded. This destroys the device. Surge protection devices (SPDs) are, like an open switch, connected to the equipotential bonding and safely short circuit the surge voltage before a destructive failure of the insulation. Like a bird on a high tension line, the electrical device is raised to a single potential and thus protected.

Surge protection is a part of the equipotential bonding system and protects against an insulation failure with short circuit and risk of fire.

During thunderstorms too, high volumes of energy are instantaneously released. These voltage peaks can penetrate a building through all manner of conductive connections and cause enormous damage.

Current statistics and estimates of insurance companies show: damage levels caused by surges – excluding consequential or outage costs – long since reached drastic levels due to the growing dependency on electronic devices. It's no surprise, then, that property insurers are checking more and more claims and stipulating the use of devices to protect against surges. Information on protection measures can be found e.g. in the Directive VDS 2010 (German guideline of the insurance association).

Internal lightning protection systems and surge voltage protection concepts are covered by current standards and meet the very latest requirements.

#### Overview of current standards:

- Internal lightning protection  
IEC 62305-4
- Surge protection  
IEC 60364-5-53

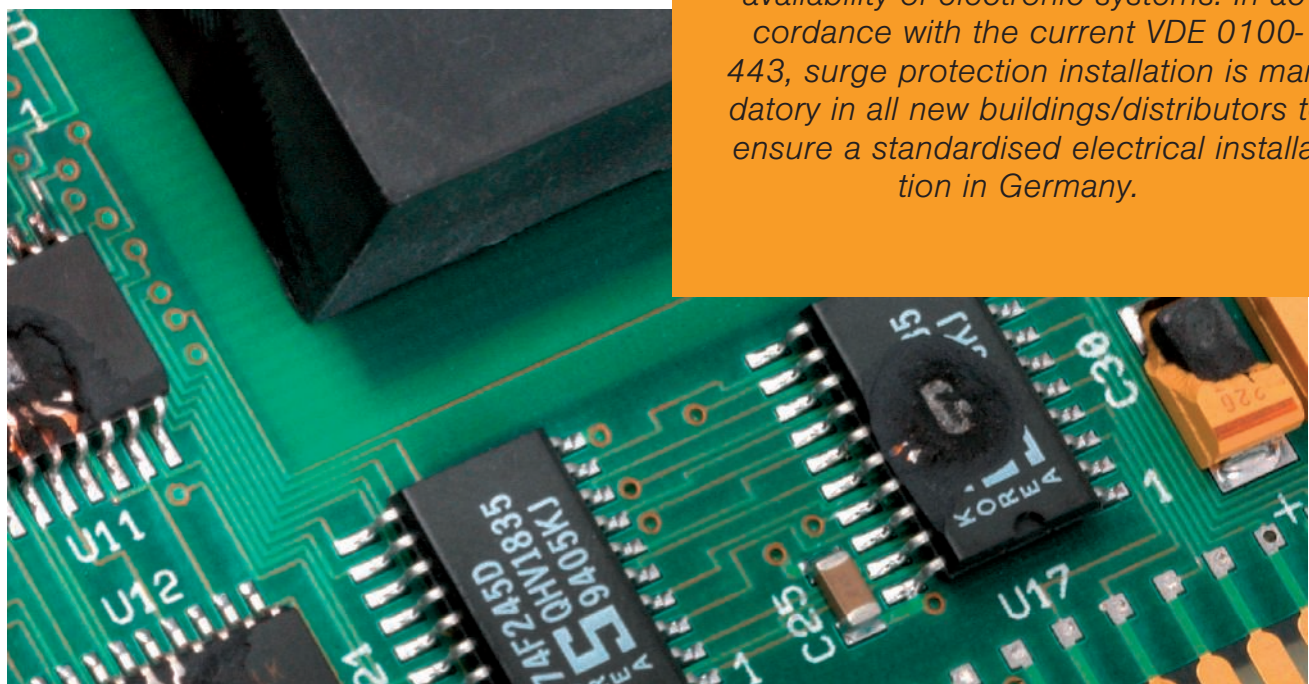

Surge voltage damage in a circuit board

*Surge protection devices increase the availability of electronic systems. In accordance with the current VDE 0100-443, surge protection installation is mandatory in all new buildings/distributors to ensure a standardised electrical installation in Germany.*



## 3.1 Equipotential bonding systems

Correct use of equipotential bonding systems prevents dangerous touch voltages between system components.

Normative requirements for equipotential bonding:

- IEC 60364-4-41  
Equipotential bonding
- IEC 60364-5-54  
Protective equipotential bonding cable
- IEC 60364-7-701  
Bathroom
- IEC 60364-7-702  
Swimming pools
- IEC 60364-7-705  
Agriculture
- IEC 61784  
Telecommunication systems
- IEC 60728-11  
Antenna earthing
- IEC 62305  
Lightning protection equipotential bonding
- DIN 18014 (foundation earthers) Lightning protection equipotential bonding

A distinction is drawn between “protective equipotential bonding” and “additional protective equipotential bonding”.

### Protective equipotential bonding

All extraneous conductive parts routed into the building must be connected with one another in order to prevent differences in potential.

### Connection of all extraneous conductive parts to the main earthing busbar (MEB)

- Foundation earth electrodes
- Lightning protection earthing
- Conductor for protective equipotential bonding
- Protective conductors within the electrical system
- Metallic water, gas and heating lines
- Antenna earthing
- Metal parts of the building, e.g. air-conditioning ducts, lift guide rails, etc.
- Metal cable shields

### Additional protective equipotential bonding

The lightning protection equipotential bonding is an extension of the general protective equipotential bonding. It is achieved by using surge protection devices to create an additional equipotential bonding system for all supply lines of the low-voltage system and information technology.

For installations under special environmental conditions, e.g. potentially explosive areas, or where explicit normative requirements apply, additional protective equipotential bonding must be implemented.

The bodies of all fixed (non-portable) equipment in the immediate vicinity of the place of installation that can be touched at the same time must be connected with all extraneous conductive parts that can be touched at the same time. This includes the functional equipotential bonding cable as per DIN 18014 and the metal main reinforcement in reinforced concrete.

#### 3.1.1 Planning methods

To avoid potential differences, the following system components must be connected, via the main earthing busbar, with equipotential bonding cables in accordance with IEC 60364-5-54:

- Electrically conductive pipelines
- Other conductive components
- Protective conductors
- Functional earth electrodes

The main earthing rail must be located in the main connection area or close to the building connections. In each building, the earthing cable and the following conductive parts must be connected to the protective equipotential bonding via the main earthing rail:

- Metallic pipelines of supply systems
- Extraneous conductive parts of the building structure
- Metallic central heating and air-conditioning systems
- Protective conductors within the electrical system
- Metallic reinforcements of building structures made of reinforced concrete

The protective equipotential bonding cables must meet the requirements of IEC 60364-441/ IEC 60364-5-54. In the lightning protection equipotential bonding, the cables of the equipotential bonding must be dimensioned for higher currents. Cross-sections must be designed according to IEC 62305.

*Requirement for equipotential bonding:*

- *Must be possible to isolate conductors*
  - *Reliable connection*
- *Can only be undone with tools*

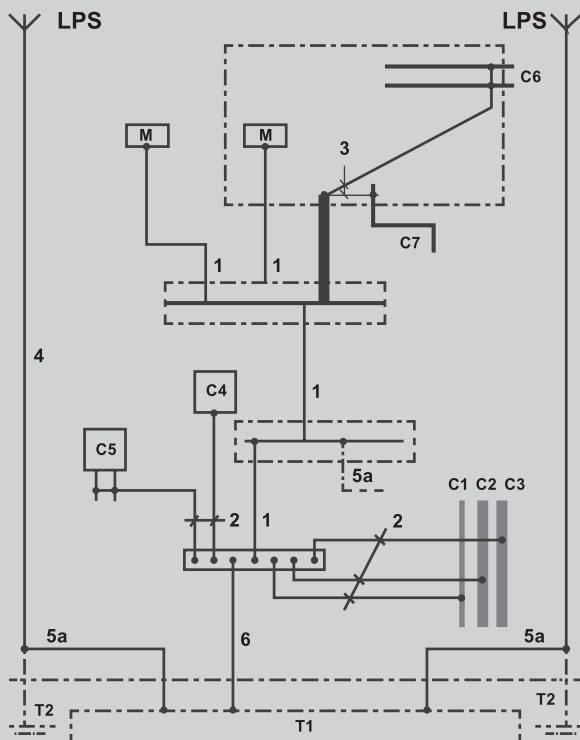

Equipotential bonding system in a building

<b>M</b>	Bodies (electrical equipment)
<b>C</b>	Extraneous conductive part (C1, C2, C3, C6, C7)
<b>B</b>	Main earthing busbar
<b>T1</b>	Foundation earth electrodes
<b>T2</b>	Earth electrodes for lightning protection
<b>LPS</b>	Lightning protection system
<b>1</b>	Protective conductors (PE)
<b>2</b>	Protective equipotential bonding cable for connection with the main earthing busbar
<b>3</b>	Protective equipotential bonding cable (for the additional protective equipotential bonding)
<b>4</b>	Lightning protection down-conductor
<b>5</b>	Earthing conductor
<b>5a</b>	Functional earthing conductors for lightning protection
<b>C4</b>	Air-conditioning system
<b>C5</b>	Heating
<b>C6/C7</b>	Metal (waste/drinking) water pipes in a bathroom

### Equipotential bonding according to IEC 60364-4- 41 and IEC 60364-5-54

Protective conductors must be protected in a suitable manner against mechanical damage, chemical or electrochemical destruction as well as against electrodynamic and thermodynamic forces. Switching devices must not be inserted into the protective conductor. Connections for testing purposes are permitted.

### 3.1.2 Versions

Each system has different environmental and normative requirements relating to equipotential bonding. To implement equipotential bonding correctly, it is therefore necessary to select the right components to use. Equipotential busbars and earthing clamps are key components of this kind of installation. In the context of lightning protection equipotential bonding, these must fulfil the requirements and undergo tests as defined in IEC 62561-1.

Material	Cross-section of cables connecting the internal metallic installations with the equipotential busbar
Copper	6 mm <sup>2</sup>
Aluminium	10 mm <sup>2</sup>
Steel	16 mm <sup>2</sup>

Table 3.1 Minimum dimensions of cables

### Minimum cross-sections according to IEC 62305-3 for lightning protection equipotential bonding

Material	Cross-section of cables connecting different equipotential busbars with one another or with the earthing system
Copper	16 mm <sup>2</sup>
Aluminium	25 mm <sup>2</sup>
Steel	50 mm <sup>2</sup>

Table 3.2: Minimum dimensions of cables, protection class I to IV

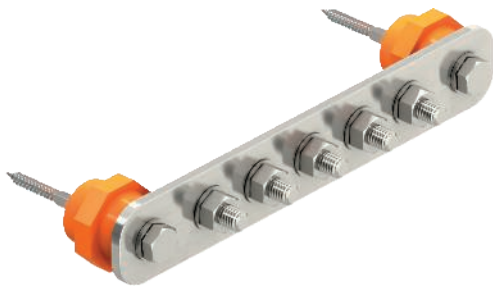

OBO "BigBar" equipotential busbar for industrial applications



Equipotential busbar 1809

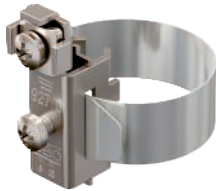

OBO 927 earthing pipe clamp



Equipotential busbar 1801

### 3.1.2.1 Industrial applications

In an industrial environment, it is particularly important that the products used are thermally and mechanically stable. The OBO type 1802 "BigBar" equipotential busbar can be used without problems in these situations as a main earthing or equipotential busbar.

#### OBO 1802 "BigBar":

- Tested with 100 kA (10/350) as per IEC 62561-1
- Can be used indoors and outdoors
- Stainless steel and copper versions available
- 5–20 pin versions available
- Quick mounting with carriage bolts

When connecting metallic pipes to the equipotential bonding, earthing pipe clamps such as OBO type 927 are generally used. These offer a wide range of advantages over pipe clamps during assembly. With their rustproof stainless steel tightening strap, they are suitable for a wide range of pipe diameters and materials.

### 3.1.2.2 Residential and office buildings

Even though the environmental conditions in residential buildings and office buildings are less challenging, here, too, it is necessary to ensure that no dangerous touch voltages can occur. Equipotential busbars types 1801 and 1809 meet all requirements for main earthing rails or equipotential busbars in these applications. They ensure secure contact for all standard cross-sections. For specialised applications, OBO offers its equipotential bonding system type 1809 NR, made from renewable raw materials with a lead-free contact strip.

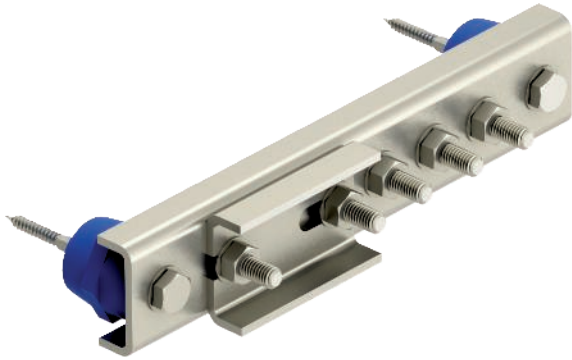

PAS equipotential busbar for potentially explosive areas

*Innovative. Unique. Patented.*

### 3.1.2.3 Potentially explosive areas

Systems in potentially explosive areas require equipotential bonding according to IEC 60079-14. All the bodies of electrically conductive parts must be connected to the equipotential bonding system. Secure equipotential bonding connections against self-loosening according to IEC 60079-14 and the Technical Rules for Operating Safety (TRBS) 2152 Part 3.

According to TRBS 2152 Part 3 and IEC 62305-3, the arresting paths of the lightning must be created in such a way that heating or ignitable sparks or spray sparks cannot become the ignition source of the potentially explosive atmosphere.

### Potentially explosive areas ATEX zones 1/ 21 and 2/ 22

The unique EX PAS equipotential busbar (equipotential busbar for potentially explosive areas) is used for lightning protection equipotential bonding according to IEC 62305-3 and protective/functional equipotential bonding according to DIN VDE 0100 Part 410/540. Thanks to its patented design, the equipotential busbar can be used for installation according to IEC 60079-14 and IEC 62305-3 in the Ex zones 1/21 and Ex zones 2/22.

The lack of ignition sparks in an explosive atmosphere has been tested on the basis of IEC 62561-1 according to explosion group IIC and can thus also be used for the explosion group IIA and IIB. The EX PAS equipotential busbars do not have their own potential ignition source and are thus not subject to the European Directive 2014/34/EU. It is confirmed that the EX PAS type equipotential busbars are suitable for use in potentially explosive areas of Zone 1/2 (gases, vapours, mist) as well as Zone 21/22 (dusts).

The EX PAS (equipotential busbar for potentially explosive areas) offers the following advantages:

- Free of ignition sparks
- Tested by independent testing body up to 75 kA
- Explosion groups IIC, IIB and IIA

### 3.2 Surge protection system for energy systems

Very large surge voltages are caused mainly by lightning strikes on or close to energy systems. Even from several hundred metres away, lightning currents can also cause impermissible surge voltages in conductor loops, through either capacitive, inductive or galvanic coupling. Large surge voltages are coupled over a radius of up to 2 km. Switching operations involving inductive loads create dangerous surge voltages in the medium and low-voltage power networks. For further information on types of damage (S1–S4) see Chapter 1.3 (starts p. 15).

#### 3.2.1 Lightning discharges (LEMP: Lightning Electro Magnetic Impulse)

The international lightning protection standard IEC 62305 describes how direct lightning strikes of up to 200 kA are safely arrested. The current is coupled into the earthing system and, due to the voltage drop at the earthing resistor, half of the lightning current is coupled into the internal installation. The partial lightning current then divides itself among the power lines entering the building (number of cores of power line entering building), while around 5% enters data cables.

The voltage drop at the earthing resistor is calculated from the product of the partial lightning current ( $i$ ) and the earthing resistance ( $R$ ). This is then the potential difference between the local earth (equipotential bonding) and the active cables, which are earthed some distance away.

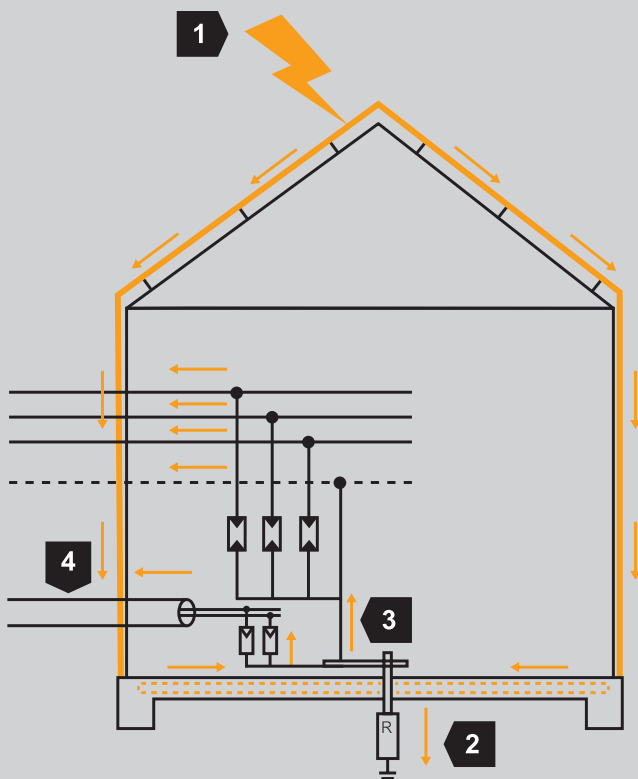

*The highest surges are caused by lightning strikes. According to IEC 62305, lightning strikes are simulated with lightning surge currents of up to 200 kA (10/350 μs).*

1	Lightning strike	100%	$I_{imp} = \text{max. } 200 \text{ kA (IEC 62305)}$
2	Earthing system	~ 50%	$I = 100 \text{ kA (50\%)}$
3	Electrical installation	~ 50%	$I = 100 \text{ kA (50\%)}$
4	Data cable	~ 5%	$I = 5 \text{ kA (5\%)}$

Typical distribution of lightning current

**Example split of Earth****System: 50%–50%**

$$i = 50 \text{ kA}; R = 1 \text{ Ohm}$$

$$U = i \times R = 50,000 \text{ A} \times 1 \text{ Ohm} = 50,000 \text{ V}$$

U	Surge voltage
i	Lightning surge current
R	Earthing resistance

The voltage resistance of the components is exceeded and uncontrolled arcing occurs. Only surge arrestors can safely arrest these dangerous voltages.

**3.2.1.1 Switching operations****(SEMP: Switching electromagnetic pulse)**

Switching operations occur due to the switching of large inductive and capacitive loads, short circuits and interruptions to the power system. They are the most common cause of surge voltages. These surge voltages simulate surge currents of up to 40 kA (8/20  $\mu$ s). Sources include e.g. motors, ballasts and industrial loads.

**3.2.1.2 Static discharges****(ESD: Electrostatic discharge)**

Electrostatic discharges are caused by friction. When a person walks on a carpet, charge separation occurs – in this instance, it is harmless to humans. However, it can interfere with and destroy electronic components. Equipotential bonding is necessary here to avoid this charge separation.

**3.2.2 Types of surge voltages**

Transient, temporary and permanent surge voltages represent the three primary types of surge voltages.

**3.2.2.1 Transient surges voltages**

Transient surges are short-lived surge voltages lasting for a matter of microseconds. Lightning and switching operations generate large transient surges that can be prevented with surge protection devices.

**3.2.2.2 Temporary and permanent surge voltages**

Temporary, or transient, surge voltages occur due to faults in the mains power supply. For example, a break in a neutral cable can generate an impermissible increase in voltage in the three-phase power system. The voltage exceeds the maximum permissible nominal voltage, electronic devices are damaged and installed surge protection devices cannot protect against these long-lasting mains frequencies. Mains frequency faults of this kind can last for between several seconds and several hours.

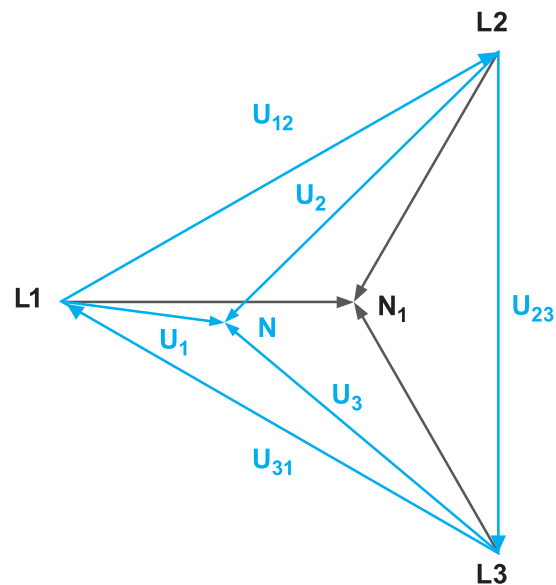

U1	Between phase (L1) and neutral conductor (N)
U2	Between phase (L2) and neutral conductor (N)
U3	Between phase (L3) and neutral conductor (N)
U12	Between phase (L1) and phase (L2)
U23	Between phase (L2) and phase (L3)
U31	Between phase (L3) and phase (L1)

*Effect of a break in a neutral wire: neutral point displacement in case of asymmetry*

**3.2.3 Planning methods**

Part 4 of the lightning protection standard IEC 62305 describes how to protect electrical and electronic systems. The safety and installation standards IEC 60364 additionally stipulate that surge voltage protection measures are required as an important protective measure in low-voltage systems.

### 3.2.3.1 Lightning protection zone concept

The lightning protection zone (LPZ) concept described in the international standard IEC 62305-4 has proved to be practical and efficient. The lightning protection zone concept is based on the principle of gradually reducing surges to a safe level before they reach terminals and cause damage. In order to achieve this, a building's entire energy network is split into lightning protection zones.

A zone is an area or building section in which all equipment requires the same level of protection. Equipotential bonding is created at each transition from one zone to another. Metallic parts are connected to the equipotential bonding directly.

Equipotential bonding is created at each transition from one zone to another. Metal parts are connected directly to the equipotential bonding, while surge protection corresponding to the relevant requirements class (type 1, 2 or 3) is installed between the active conductors and the earth potential.

#### Benefits of the lightning protection zone concept

- Minimisation of the surge voltage couplings into other cable systems by arresting the energy-rich, dangerous lightning currents directly at the building entry point and at the cable's point of transition between zones.
- Local equipotential bonding within the protection zone.
- Reduction of malfunctions due to magnetic fields.
- Economic, easy to plan individual protection concept for new and old buildings and reconstructions.

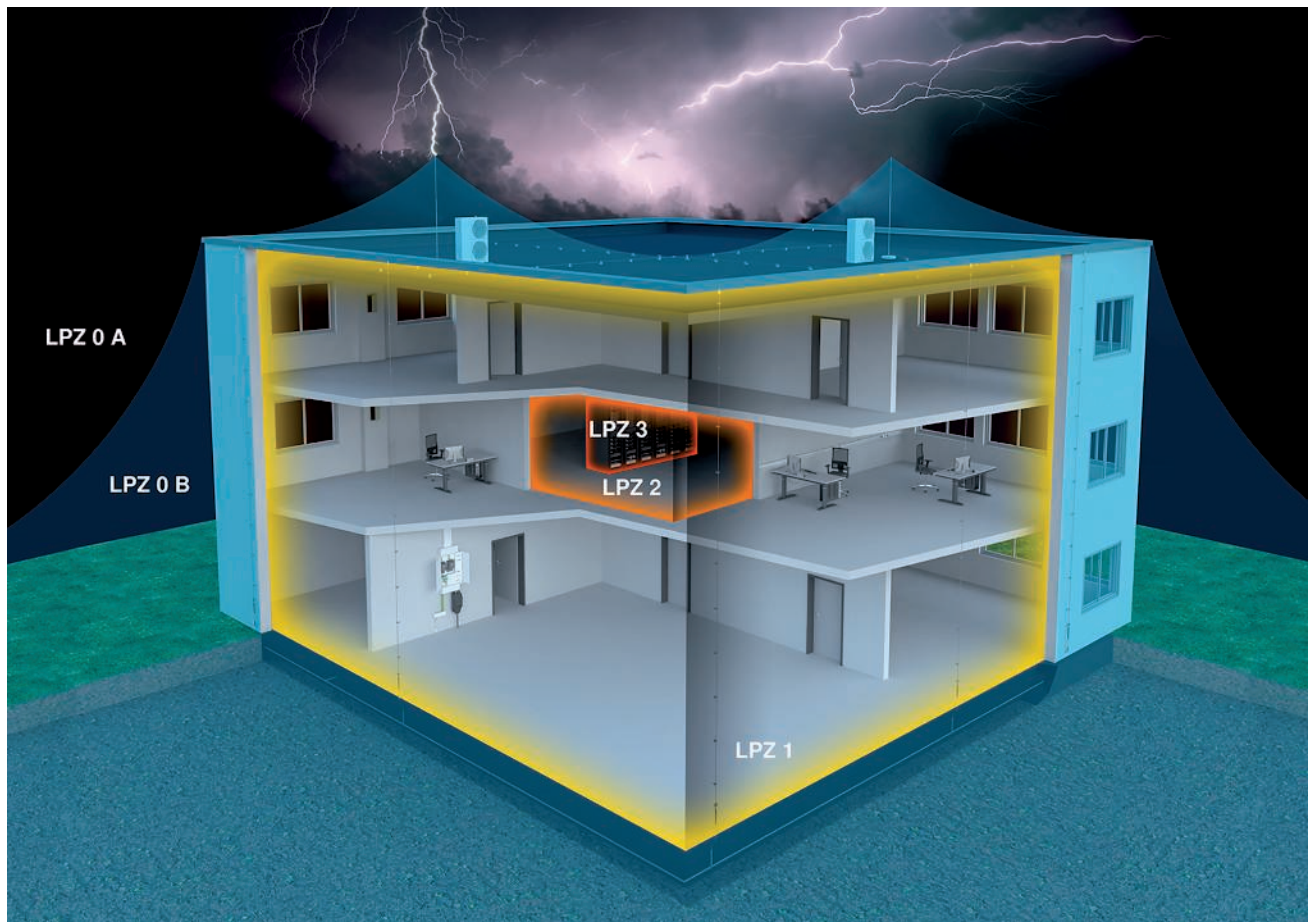

LPZ 0 A	Dark Blue	Unprotected zone outside the building. Direct lightning strike, no shielding against electromagnetic interference pulses LEMP (Lightning Electromagnetic Pulse)
LPZ 0 B	Light Blue	Zone protected by external lightning protection system. No shielding against LEMP
LPZ 1	Yellow	Zone inside the building. Low partial lightning energies possible
LPZ 2	Orange	Zone inside the building. Low surges possible
LPZ 3	Red	Zone inside the building (can also be the metal housing of a consumer) No interference pulses through LEMP or surges

Division of the building into lightning protection zones (LPZ)



### 3.2.3.2 Type classes of surge protection devices

In accordance with IEC 61643-11, OBO SPDs (surge protection devices) are divided into three type classes – type 1, type 2 and type 3 (classes I, II and III). These standards contain regulations, requirements and tests for surge protection devices used in AC networks with nominal voltages of up to 1,000 V AC and nominal frequencies of between 50 and 60 Hz.

T2



#### Surge arrester type 2

Surge arrestors of type 2/class II are used in main and sub-distributors. The protection devices must be used before a residual current protective device (RCD), as it would otherwise interpret the arrested surge current as a residual current and interrupt the power circuit. The surge voltages are simulated with test impulses, typically of 20 kV with the pulse shape 8/20  $\mu$ s. To protect sensitive controllers, the protection level must be below 1,500 V.

T1

T1 + T2



#### Lightning arrester type 1 and combination arrester type 1+2

Lightning arrestors of type 1/class I are used at the entry to the building. The connection is effected parallel to the external lines of the energy network. The direct lightning strike is simulated with test impulses of up to 100 kA with the pulse shape 10/350  $\mu$ s. The protection level must be below 4,000 V. Following consultation with the local energy provider and in accordance with the VDN Directive, use before the main meter device is also possible. Combination arrestors, which fulfil the type 1 class (class I) and the type 2 class (class II), must also fulfil the requirements for test pulses of the pulse form 8/20  $\mu$ s.

T3



#### Surge arrester type 3

Type 3/class III surge arrestors are used to protect against inductive coupling and switching surges in the device power circuits. These surge voltages occur primarily between the phase (L) and the neutral cable (N). The Y circuit protects the L and N lines with varistor circuits and makes the connection to the PE line through a spark gap. Thanks to this protection circuit, transverse voltages are arrested without the residual current device (RCD) interpreting the surge current as a residual current and interrupting the power circuit. The surge voltages are simulated with hybrid test impulses of up to 20 kV and 10 kA with the pulse shape 1.2/50  $\mu$ s and 8/20  $\mu$ s. To protect sensitive controllers, the protection level must be below 1,500 V. A surge voltage protection concept must take account of all electrically conductive connections and must be structured in levels. Each protection level builds on the one before it and reduces the energy content of the surge.

**Choosing the right surge protection devices**

The classification of surge protection devices into types means they can be matched to different requirements with regard to location, protection level and current-carrying capacity. Table 3.3 below provides an overview of the zone transitions. It also shows which OBO surge protection devices can be installed in the energy supply network and their respective function.

For insulation coordination, the protection level of the SPDs must be less than or equal to the rated impulse voltage of the electrical system according to IEC 60364-5-53.



Zone transition	Protection device and device type	Product example	Product figure
LPZ 0 B to LPZ 1	SPD for lightning protection equipotential bonding according to IEC 62305 for direct or nearby lightning strikes. Devices: Type 1 (class I)/type 1+2 (class I+II), e. g.: MCF100-3+NPE+FS Required surge voltage resistance: 4 kV OBO SPD protection level: < 1.5 kV Installation e.g. in the main distributor/at the entrance to the building	MCF100-3+NPE+FS Item no.: 5096987	<b>T1</b> 
LPZ 1 to LPZ 2	SPD for equipotential bonding according to IEC 60364 in case of surge voltages. Devices: Type 2 (class II), e.g.: V20 Required surge voltage resistance: 1.5 kV OBO SPD protection level: < 1.3 kV Installation e.g. in the sub-distributor/storey distributor	V20 Item no.: 5095253	<b>T2</b> 
LPZ 2 to LPZ 3	Surge protection for surge protection of the terminals. Devices: Type 3 (class III), e.g.: ÜSM-A Required surge voltage resistance: 1.5 kV OBO SPD protection level: < 1.3 kV Installation e.g. on or directly in front of the terminal	ÜSM-A Item no.: 5092451	<b>T3</b> 

Table 3.3: SPDs at zone transitions

### 3.2.3.3 Protection devices in various power supply systems

#### 4-wire networks, TN-C network system

In the TN-C network system, the electrical unit is supplied through the three external lines (L1, L2, L3) and the combined PEN line. Usage is described in IEC 60364-5-53.

#### Lightning current arrester, type 1

Type 1 lightning current arresters and combination arresters are used in the 3-pin circuit (e.g.: MCF75-3+FS).

#### Surge arrester type 2

Type 2 surge protection devices (SPDs) are used in the 3+1 circuit (e.g. V20 3+NPE). With the 3+1 circuit, the external conductors (L1, L2, L3) are connected to the neutral conductor (N) via arrestors. The neutral conductor (N) is connected to the protective earth via a collective spark gap.

#### Surge arrester type 3

Type 3 surge protection devices (SPDs) are used in the device power circuits. A Y circuit protects the L and N lines with varistor circuits and makes the connection to the PE line through a collective spark gap (e.g.: ÜSM-A).

*An SPD is to be used between the neutral and protective conductors 0.5 m behind the separation of the PEN conductor.*

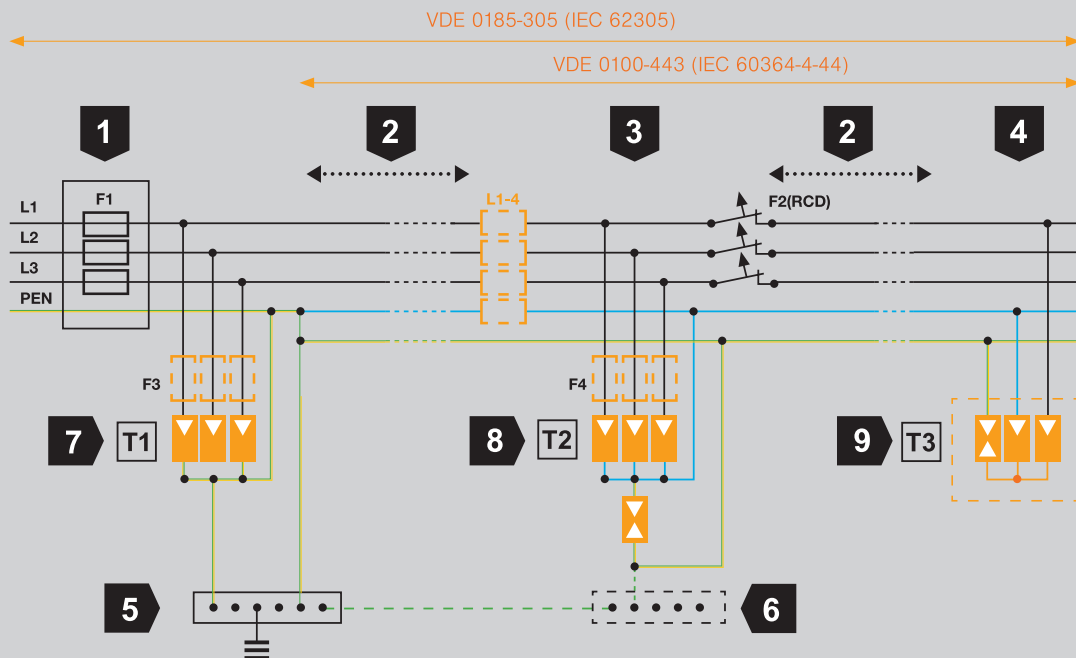

1	System fuse F1
2	Cable length between arrestors
3	Circuit distribution board, e.g. sub-distributor
4	Final circuit
5	Main earthing busbar (MEB)

6	Local equipotential busbar (PAS), optional
7	Type 1 (class I) surge protection devices (SPDs)
8	Type 2 (class II) surge protection devices (SPDs)
9	Type 3 (class III) surge protection devices (SPDs)

4-wire networks, TN-C network system and scope of standards

### 5-wire networks, TN-S and TT network system

In the TN-S network system, the electrical unit is supplied through the three external lines (L1, L2, L3), the neutral cable (N) and the earth cable (PE). In the TT network, however, the electrical unit is supplied through the three external lines (L1, L2, L3), the neutral cable (N) and the earth cable (PE). Usage is described in IEC 61643-11.

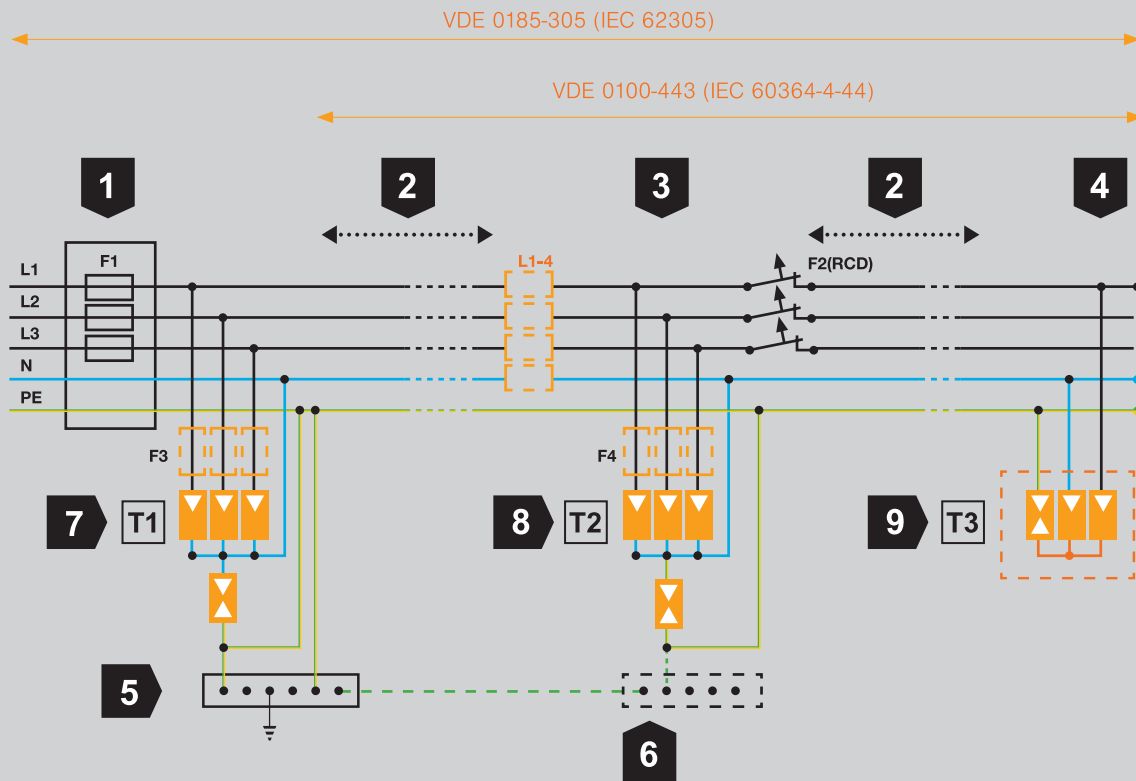

<b>1</b>	System fuse F1
<b>2</b>	Cable length between arrestors
<b>3</b>	Circuit distribution board, e.g. sub-distributor
<b>4</b>	Final circuit
<b>5</b>	Main earthing busbar (MEB)

<b>6</b>	Local equipotential busbar (PAS), optional
<b>7</b>	Type 1 (class I) lightning arrestor
<b>8</b>	Type 2 (class II) surge protection devices (SPDs)
<b>9</b>	Type 3 (class III) surge protection devices (SPDs)

5-wire networks, TN-S and TT network system

#### Advantages of the 3+1 circuit:

- Universally suitable for TN and TT networks
- Insulating spark gap between neutral conductor (N) and earth (PE)
- Low protection level between phase (L) and neutral conductor (N)
- Use in front of the FI protection switch (RCD) also approved in TT network

### Type 1/type 1+2 lightning arrestors (class I/class I+II)

Type 1/type 1+2 lightning arrestors are used in the 3+1 circuit (e.g. MCF100-3+NPE-FS, 5096987). With the 3+1 circuit, the external conductors (L1, L2, L3) are connected to the neutral conductor (N) via arrestors. The neutral conductor (N) is connected to the protective earth via a collective spark gap. Following consultation with the local energy provider and in accordance with the VDN Directive, use before the main meter device is also possible.

### Surge arrester type 2 (class II)

Type 2 surge arrestors are used in the 3+1 circuit (e.g. V20-3+NPE). With the 3+1 circuit, the external conductors (L1, L2, L3) are connected to the neutral conductor (N) via arrestors. The neutral conductor (N) is connected to the protective earth via a collective spark gap. The arrestors must be used before a residual current protective device (RCD), as it would otherwise interpret the arrested surge current as a residual current and interrupt the power circuit.

### Surge arrester type 3 (class III)

Type 3 surge arrestors are used to protect against surges in the terminal power circuits. These transverse surges occur primarily between L and N. A Y circuit protects the L and N lines with varistor circuits and makes the connection to the PE line through a collective spark gap (e.g.: ÜSM-A). This protection circuit between L and N prevents surge currents from transverse voltages being conducted towards PE, the RCD thus interprets no residual current. You can find the relevant technical data on the product pages.

### 3.2.3.4 Selection criteria (voltage resistance of devices – protection levels) – Selection aid

The rated surge voltage resistance against transient surges is defined according to the installation standard IEC 60664 for the various installation locations. The voltage resistance of the devices must be coordinated with the protection levels of the lightning and surge protection devices. Coordination of insulation should take place according to EN 60664.

Nominal voltage of power supply system (1) (mains) according to IEC 60038 (3)		Voltage between phase and neutral wire derived from the nominal AC or nominal DC voltage up to and including  v	Rated surge voltage (2) v			
			Surge voltage category (4)			
Three-phase	Single-phase		I	II	III	IV
	120/240	50	330	500	800	1500
		100	500	800	1500	2500
		150	800	1500	2500	4000
230/400, 277/480		300	1500	2500	4000	6000
400/690		600	2500	4000	6000	8000
1000		1000	4000	6000	8000	12000

(1) For application to different low-voltage networks and their nominal voltages see Annex B

(2) Equipment with this rated surge voltage may be used in systems in accordance with IEC 60364-4-443.

(3) The slash ("/") indicates a three-phase, 4-wire system. The lower value represents the voltage between the phase and the neutral conductor while the higher value is the voltage between phases. Where only one value is given, it relates to three-phase, 3-wire systems and describes the voltage between phases.

(4) For more information on the surge voltage categories see 2.2.2.1.1.

Table 3.4: Rated surge voltage for equipment in accordance with installation standard IEC 60664

### Exposed cable supply

Buildings with an exposed cable supply must be protected with type 1 SPDs, even if the supply cable is run between the last mast of the exposed cable and the building as an earth cable.

Low-voltage cable networks require protection against surge voltages of atmospheric origin and switching surges due to the following reasons:

- Surge voltages are not weakened or attenuated sufficiently by earthing cables.
- Surge voltage damage frequently occurs on resources operated on power and data/telephone networks.
- The use of control and communication equipment is continually increasing.

If surge protection is used for the low-voltage system, then suitable surge protection devices (SPD) should be used for the telecommunications and data systems.

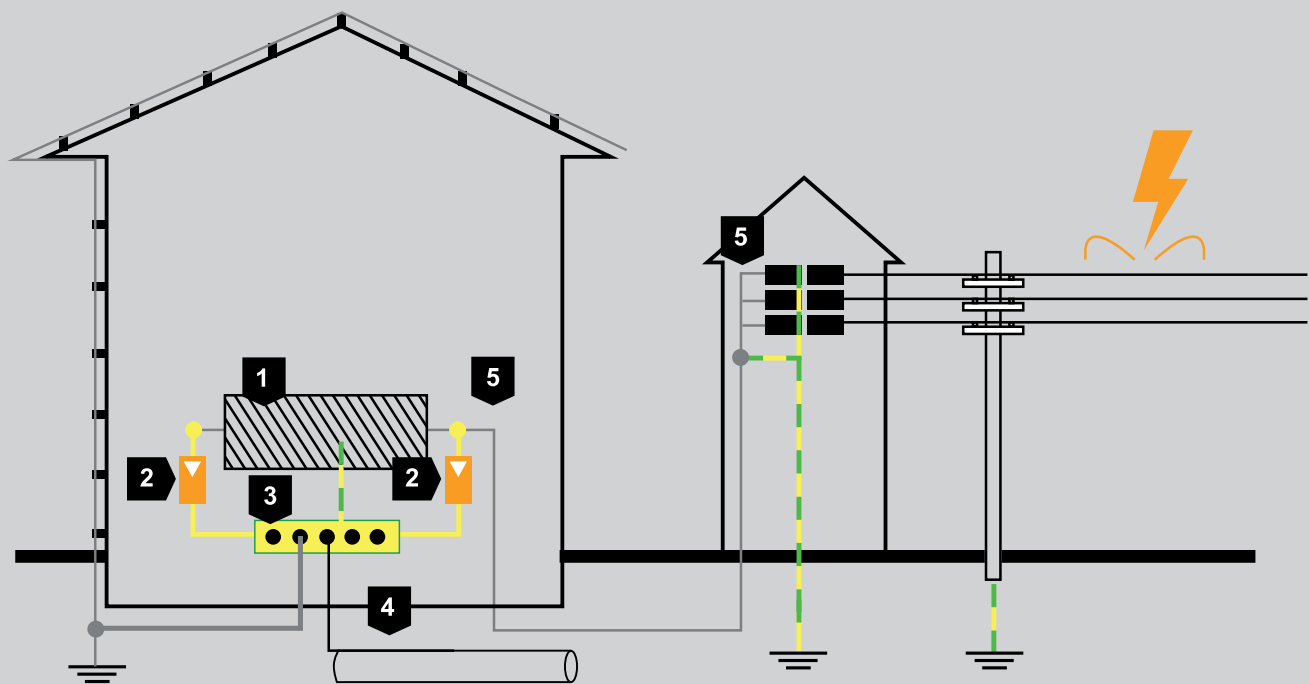

Exposed cable supply

<b>1</b>	Sensitive device
<b>2</b>	SPD (type 1 or type 1+2)
<b>3</b>	Main earthing busbar (MEB)
<b>4</b>	Metal cable
<b>5</b>	Power supply (L1, L2, L3 and PEN)

## Questions about DIN VDE 0100-443/-534

### 1. What is now obligatory according to DIN VDE 0100-443?

Answer: DIN VDE 0100-443 prescribes surge arrestors in front of resources of surge voltage category I and II. In housing, terminals with this rated surge voltage are used (e.g. household appliances, computers, tools, etc.).

In addition, DIN VDE 0100-443 recommends the use of surge arrestors for IT interfaces. DIN VDE 0100-443 describes surge voltages from atmospheric influences or impacts of switching actions.

### 2. Which arrestors should be used?

Answer: As protection against lightning impacts and switched surge voltages, which ingress into the system via the supply line, type 2 SPDs must be installed at the feed point/building entry.

In the case of an outdoor line infeed or a lightning protection system according to VDE 0185-305, type 1 SPDs should be used for lightning protection equipotential bonding.

### 3. Must additional measures be taken against surge voltages in the case of terminals of sub-distributors which are at a cable length of more than 10 metres from the last surge arrestor?

Answer: The measures for sensitive terminals or sub-distributors which are at a cable length of more than 10 m from the last surge arrestor should be agreed individually between the installation engineer and the client. If, within a building, switching surge voltages are generated and cables leave the building, then there is the necessity of checking further measures and documenting the result.

### 4. Must new PV systems or those erected at a later date be protected?

Answer: A PV system must be erected according to DIN VDE 0100-712. It is necessary to erect the surge protection on the AC side according to DIN VDE 0100-443 and to check it for IT and communications technology. According to Supplement 5 of DIN VDE 0185-305-3, surge protection on the DC side is also necessary.

*Quote from VDE 0100-443: "The erection of surge protection devices (SPDs) should ensure a voltage limitation according to the insulation coordination, in order to avoid dangerous spark formation and resulting fires."*

*Summary: Surge protection is preventive fire protection!*

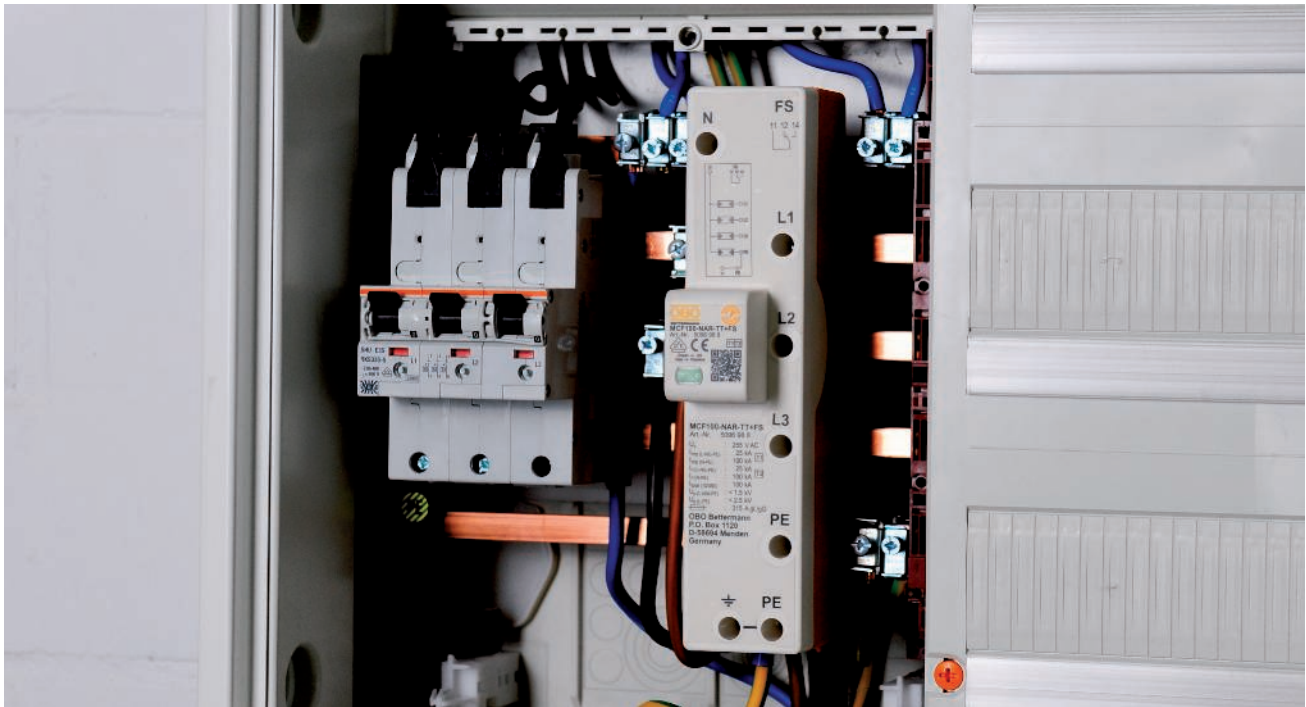

Type 1+2 combination arrester MCF...NAR on the 40-mm busbar in mains-side connection compartment

#### Lightning arrester in the pre-counter area

Type 1 lightning arrestors or type 1+2 combination arrestors can be used in the mains-side connection compartment (NAR), previously termed as the "lower connection compartment".

If lightning currents (external lightning protection or exposed cable infeed) are expected at the infeed point of the electrical system, a type 1 or type 1+2 lightning and surge protection device is required. An installation through direct mounting on the 40 mm busbar system in the lower or mains-side connection compartment (NAR) of the meter cabinet is possible.

The new series of MCF...NAR combination arrestors of type 1+2 is the ideal solution for use on the 40 mm busbar system. The requirements for the mandatory installation of surge protection according to DIN VDE 0100-443 and part -534 are fulfilled.

#### Benefits:

- DIN VDE 0100-443/-534 for installation of surge protection is fulfilled.
- The low protection level of under 1,500 V is suitable for protection of terminals.
- Installation on the 40 mm busbar saves space in the meter cabinet.
- The function display and optional remote signalling contact signal the functionality.
- Power stages are available for all building types.









Examples: MCF-xxx-NAR-TNC (+FS) for TN-C networks and MCF-xxx-NAR-TT (+FS) for TT and TN-S networks

### Surge protection for the power supply

Use in the power connection compartment (NAR/40 mm busbar)

Application In the building	Network system	Remote signalling	I <sub>total</sub> (10/350)	Maximum fuse	Type	Item no.
 Without lightning protection system	TN-C 3-pin	✗	25 kA	160 A gL/gG	MCF25-NAR-TNC	5096950
	TN-C 3-pin	✓			MCF25-NAR-TNC + FS	5096953
 With exposed cable supply	TT and TN-S 3+NPE	✗	30 kA		MCF30-NAR-TT	5096961
	TT and TN-S 3+NPE	✓			MCF30-NAR-TT+FS	5096963
 With lightning protection system (BZK 3+4)	TN-C 3-pin	✗	38 kA	160 A gL/gG	MCF38-NAR-TNC	5096971
	TN-C 3-pin	✓			MCF38-NAR-TNC+FS	5096973
	TT and TN-S 3+NPE	✗	50 kA		MCF50-NAR-TT	5096975
	TT and TN-S 3+NPE	✓			MCF50-NAR-TT+FS	5096977
 With lightning protection system (BZK 1+2)	TN-C 3-pin	✗	75 kA	315 A gL/gG	MCF75-NAR-TNC	5096982
	TN-C 3-pin	✓			MCF75-NAR-TNC+FS	5096983
	TT and TN-S 3+NPE	✗	100 kA		MCF100-NAR-TT	5096985
	TT and TN-S 3+NPE	✓			MCF100-NAR-TT+FS	5096988

FS = Potential-free remote signalling (NO/NC)

**Coordination of insulation**

The rated surge voltage depends on the surge voltage category. In surge voltage category I, for example, for a single-phase connection to a 230 V AC network, the minimum rated surge voltage is 1.5 kV. A surge voltage arrester must limit the voltage to this or a smaller value.

The protection level of a surge voltage arrester is the maximum voltage when the nominal surge current is applied to it. If the actual surge current is smaller than the nominal surge current, the response voltage and hence also the protection level drops.

**Required protection level for 230/400 V equipment in accordance with IEC 60364-4-443**

<b>1</b>	Resource at the infeed point of the system
<b>2</b>	Resource as a part of the fixed installation
<b>3</b>	Resource for connection to the fixed installation
<b>4</b>	Resource requiring special protection
<b>5</b>	Installation location, e.g. main distributor
<b>6</b>	Installation location, e.g. sub-distributor
<b>7</b>	Installation location, e.g. devices
<b>8</b>	Measured pulse voltage (voltage resistance) $U_w$ of the resources (green line)
<b>9</b>	Protection level $U_p$ of the OBO surge protection devices (SPDs) (orange line)
<b>10</b>	Usable difference (e.g.: 2.5 kV corresponds to a supply line length 1.25 m supply line @ 20 kA (8/20))

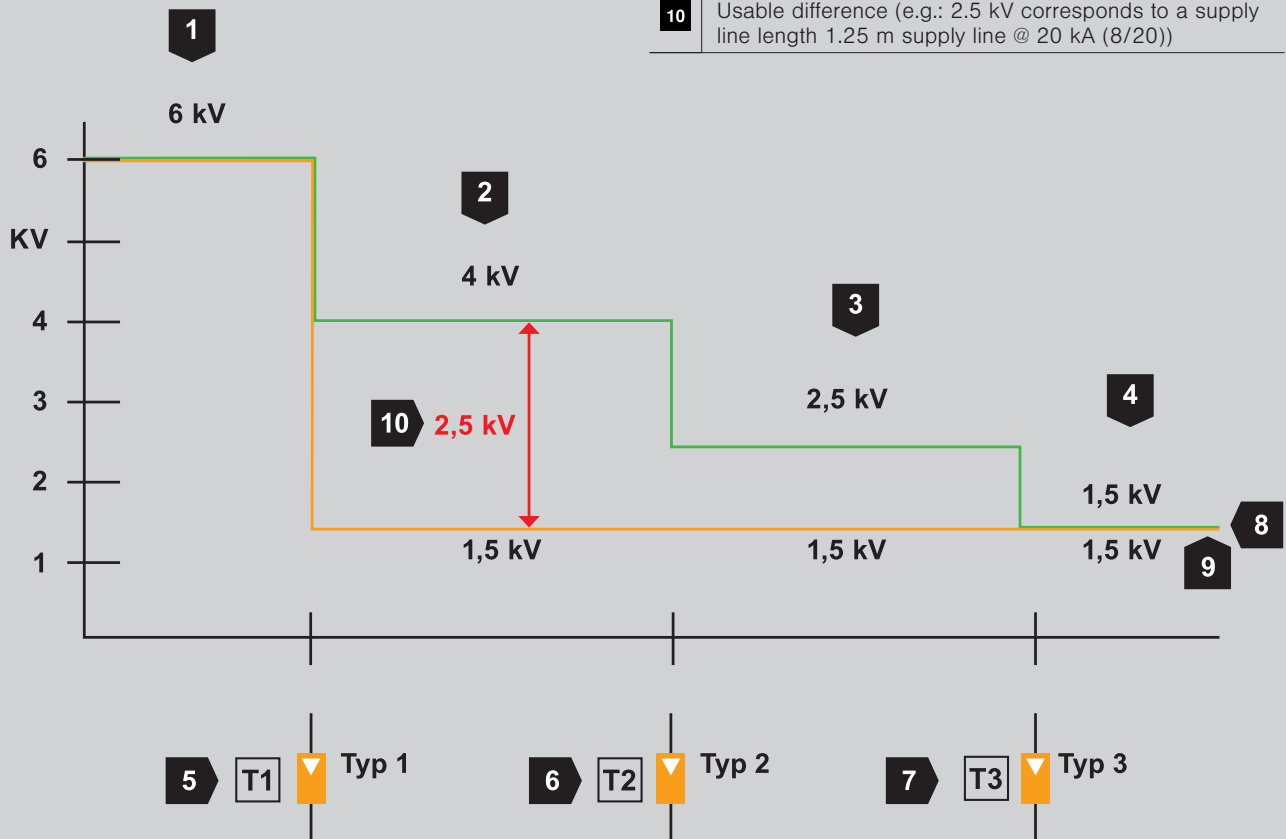

Coordination of insulation as per EN 60664-1

### 3.2.3.5 Installation requirements

The installation standard for surge protection devices, IEC 60364-5-53, covers protection against surge voltages resulting from indirect and remote lightning strikes and switching operations. Surge protection devices can also be known as “surge protective devices” and “devices for protection against surges”. The standard offers help in selecting and installing surge protection devices in order to reduce downtime in low-voltage systems. In buildings with an external lightning protection system as per IEC 62305, type 1 surge protection devices must be used to connect the supply lines routed in from outside the building to the lightning protection equipotential bonding at the transitions between lightning protection zones 0 and 1.

As of 2016, surge protection in all new buildings and in electrical installations is mandatory for electrical installations conforming with the standard. The new standards HD 60364-4-443 and IEC 60364-4-44 describe the decision criteria as to when and how surge protection measures are required in systems and buildings.

#### Minimum cross-sections for lightning protection equipotential bonding

The length of the connection cable for surge protection devices is a significant aspect of the installation standard IEC 60364-5-53. To ensure adequate protection of systems and devices, the maximum surge voltage that can occur must be smaller than or equal to the surge voltage resistance of the devices to be protected. The sum of the protection level of the surge protection devices and the voltage drop on the supply lines must remain below the voltage resistance. To minimise the voltage drop on the supply line, the length, and hence inductance, of the cable must be kept as low as possible. IEC 60364-5-53 recommends a total length for the connection cable to the surge protection device of less than 0.5 m and certainly no more than 1 m.

The following minimum cross-sections must be observed for lightning protection equipotential bonding: for copper 16 mm<sup>2</sup>, for aluminium 25 mm<sup>2</sup> and for iron 50 mm<sup>2</sup>. At the lightning protection zone, transition from LPZ 0B to LPZ 1, all metal installations must be integrated into the equipotential bonding system. Active lines must be earthed using suitable surge arrestors.

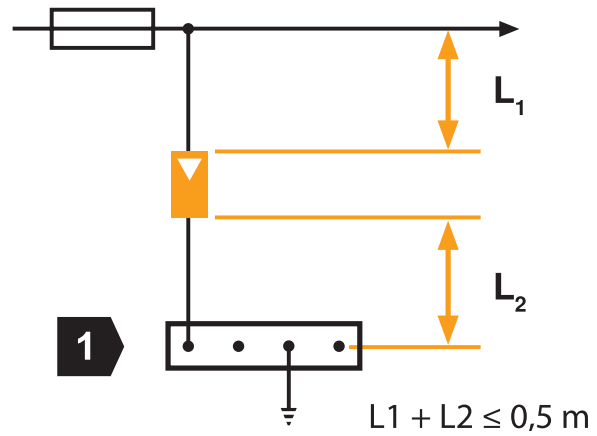

Maximum length of supply line as per IEC 60364-5-53

1	Main earthing busbar or protective conductor rail
L <sub>1</sub>	Supply line to protection device
L <sub>2</sub>	Connection between protection device and equipotential bonding

#### Connection length, alternative V wiring and cross-sections

If the surge protection device is tripped by a surge voltage, the supply lines, fuse and protection device conduct surge current. This produces a voltage drop at the impedances of the lines. The ohmic component is negligible compared to the inductive component.

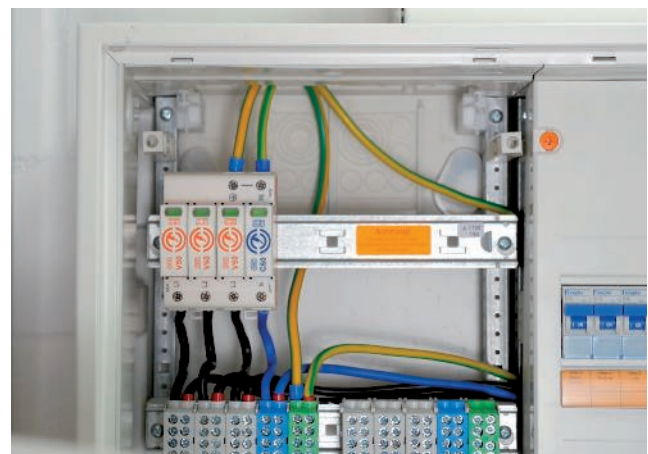

Mounting of the type 1+2 V50 combination arrester in the upper meter connection compartment

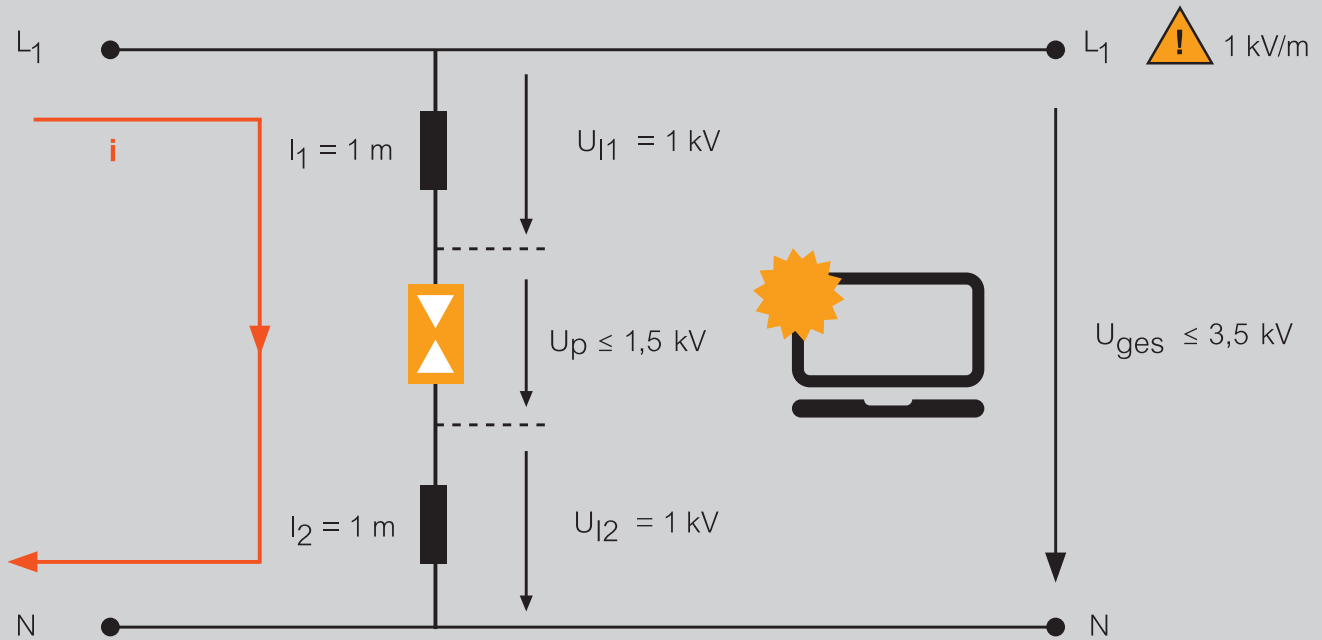

Voltage drop on the supply line when surge current is applied ( $i$  = lightning current,  $U_{total}$  = surge voltage at protection device)

Account must be taken of the lengths of the connection cables. Due to the inductance  $L$ , rapid increases in current (100–200 kA/μs) result in large voltage increases. Assumption: 1 kV per m

**For the dynamic voltage drop ( $U_{dyn}$ ), the following equation applies:**

$$U_{dyn} = i \times R + (di/dt) L$$

$$U_{dyn} = 10 \text{ kA} \times 0.01 \text{ Ohm} + (10 \text{ kA}/8 \text{ } \mu\text{s}) \times 1 \text{ } \mu\text{H}$$

$$U_{dyn} = 100 \text{ V} + 1,250 \text{ V} = 1,350 \text{ V}$$

$U_{dyn}$	Voltage drop on the cable
$i$	Surge current
$R$	Ohmic line resistance
$di/dt$	$\Delta$ current change/ $\Delta$ time
$L$	Inductance of cable (assumption: 1 μH/m)

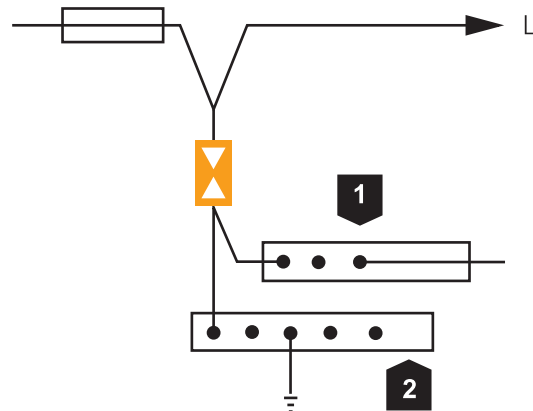

1	Protective conductor rail
2	Main equipotential busbar

V wiring

The dynamic voltage drop  $U_{dyn}$  is calculated on the basis of the product of the inductive component and the change in current over time ( $di/dt$ ). These transient surges are several 10 kA high.

### V wiring

Surge protection devices can alternatively be connected in a V shape. In this case, no separate branch cables are used for connecting the protection devices.

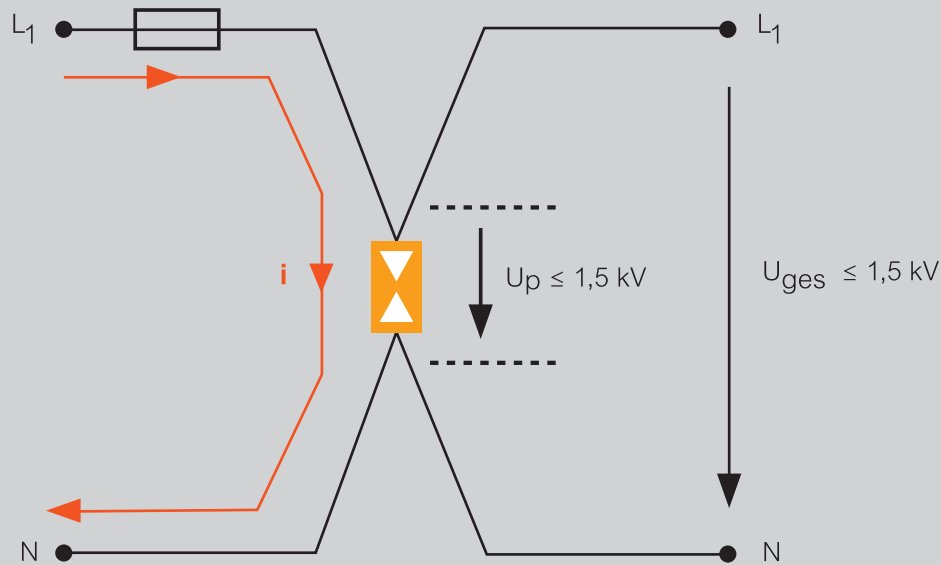

V wiring on a surge arrester according to IEC 60634-5-53 ( $i$  = lightning current |  $U_{total}$  = surge voltage at protection device)

The connection cable to the protection device is crucial for achieving an optimum protection level.

In accordance with IEC installation directives, the length of the branch cable to the arrester and the length of the line from the protection device to the equipotential bonding should, in total, be less than 0.5 m. If the cables are longer than 0.5 m, V wiring must be selected.

*A pulse current of 10 kA 8/20  $\mu$ s generates a voltage drop of 1 kV per metre of cable.*

*Solution options:*

- *Installation of a second SPD near to the resource to be protected*
- *Use of V wiring*
- *Local equipotential bonding (e.g. with the metal housing of the switchgear cabinet)*

Material	Cross-section of cables connecting different equipotential busbars together or with the earthing system	Cross-section of cables connecting the internal metallic installations with the equipotential busbar
Copper	16 mm <sup>2</sup>	6 mm <sup>2</sup>
Aluminium	25 mm <sup>2</sup>	10 mm <sup>2</sup>
Steel	50 mm <sup>2</sup>	16 mm <sup>2</sup>

Table 3.5: Minimum dimensions of equipotential bonding cables, protection class I to IV

**Cross-sections**

According to IEC 60364-5-53, type 1 or 1+2 lightning arrestors with a cross-section of at least 16 mm<sup>2</sup> of copper capable of carrying lightning current are required. Type 2 surge protection devices with a minimum cross-section of 4 mm<sup>2</sup> copper, or the standard commercial minimum connection cross-section of 6 mm<sup>2</sup>, must be connected. Account must additionally be taken of the maximum short-circuit currents occurring at the place of installation.

**Installation locations and cable lengths**

Looking in the direction of energy flow, additional SPDs must installed after the infeed point of the electrical system, for example in sub-distributors or at the sockets.

According to VDE 0100-534, Chapter 534.4.9 "Effective protection area of SPDs", additional protection measures should be employed, if the cable length between the SPD and the resource to be protected is more than 10 m, e.g.:

- a) Additional SPD as close as possible to the resource to be protected.
- b) Use of one-port SPD ( $U_p (50\%) < U_w$ ) at the supply point.
- b) Use of two-port SPDs at the supply point.

With points b) and c), additional measures, such as the use of shielded cables, are necessary.

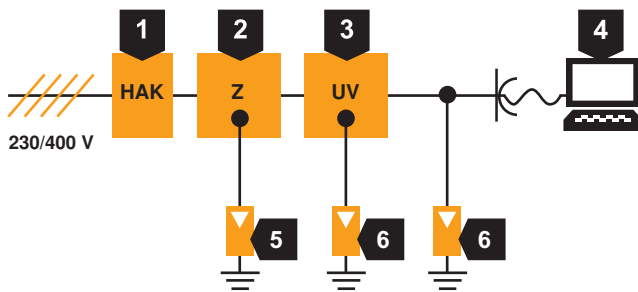

1	Building connection box
2	In or near the central meter system/main distributor
3	Sub-distributor
4	Terminal devices
5	SPD type 1 and/or type 2
6	SPD type 2 or type 3

Installation location of SPDs (maximum cable length between SPD and terminal = 10 m)



1	Feed line
2	IT terminals
3	Cable length > 10 m (second SPD required)

Maximum cable length between SPD and terminal

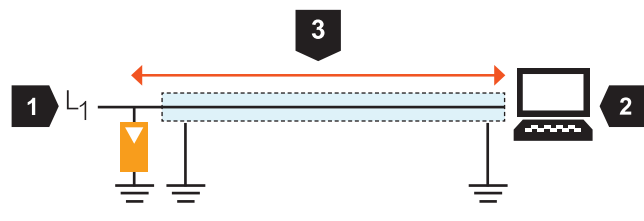

1	Feed line
2	IT terminals
3	Cable length > 10 m (earthed cable shield)

Shielded cable routing between SPD and terminal

### Back-up fuse

To provide protection in case of short circuits in surge protection devices, a back-up fuse (F2) is used. OBO specifies a maximum fuse rating for all devices. If an upstream fuse (F1) has a smaller or equal value than the maximum fuse current, a separate fuse/back-up fuse (F2) is however not needed before the surge protection device. If the rating of the system fuse (F1) is higher than the maximum fuse current, a fuse corresponding to the specified maximum fuse current must be fitted before the protection device. The rating of the fuse (F2) before the protection device should be as high as possible. The pulse resistance of a higher-rated fuse is greater than that of a lower-rated one.

*Small fuses can be destroyed by energy-rich surge currents.*

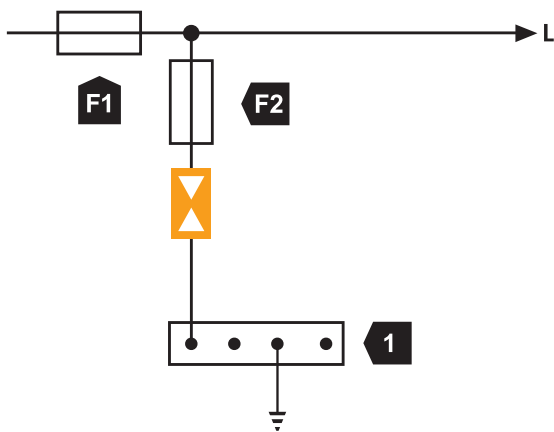

*Back-up fuse on surge protection device*

<b>1</b>	Main earthing rail
<b>F1</b>	System fuse
<b>F2</b>	Back-up fuse

### 3.2.3.6 Protection circuit

Only an effective protection circuit providing uninterrupted surge protection can prevent dangerous potential differences in devices/systems. When implementing a surge protection concept it is necessary to obtain information on the devices and system components to be protected and, where possible, gather them into lightning protection zones (LPZs).

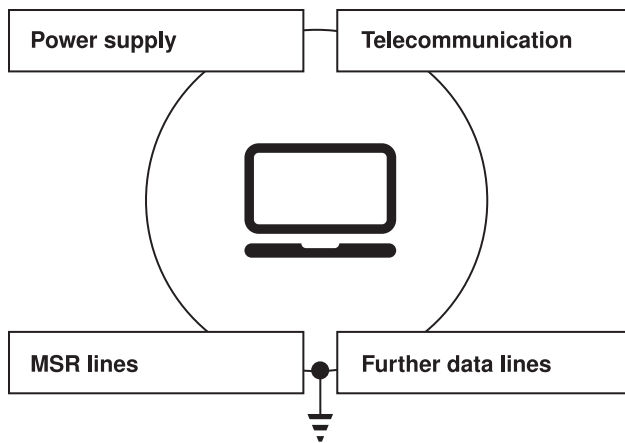

*Protection circuit around an electronic device*

Circuits that need to be incorporated into the equipotential bonding system:

- Power supply lines
- Network and data cables
- Telecommunications cables
- Antenna cables
- Control cables
- Metallic pipes  
(e.g. water and drainage pipes)

The cables must be incorporated into the local equipotential bonding system either directly or using suitable arrestors. The best lightning and surge protection concept is useless unless every electrical and metal line entering the building or the protection circuit is included in the protection concept.

### 3.2.4 Versions

In building structures and electrical systems, measures for lightning and surge protection and e.g. structural fire safety must be taken into account and tailored to one another right from the planning stage. Requirements in laws such as the German state building regulations and the current standards must be observed. Suitable protection concepts must be agreed upon jointly by planners, lightning protection engineers, electricians and the operator/client. The stipulations of insurance companies and network operators should also be taken into account.

#### 3.2.4.1 Installation with residual current devices (RCDs)

For a fraction of a second, surge protection devices generate all-pole equipotential bonding. To ensure maximum availability, surge arrestors must be fitted upstream of the RCDs. In this way, the surge current is arrested to earth first, preventing accidental tripping of the RCD. According to IEC 60364-5-53, use upstream of an RCD in the TT network is only permitted in the case of the “3 + 1 circuit”. Here, the three external conductors are connected to the neutral wire via the surge arrestors and an insulating N-PE spark gap is used in the earthing line. If the surge arrestor can only be fitted after the RCD, a surge-current-proof RCD must be used.



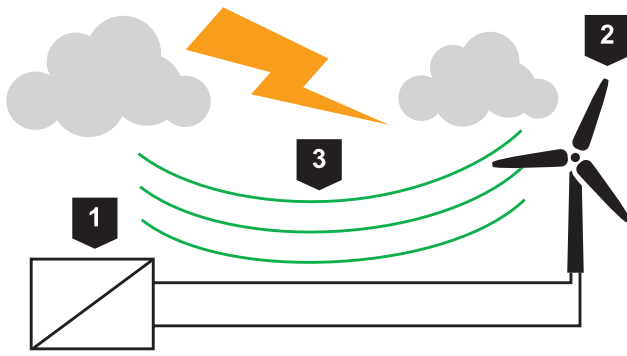

<b>1</b>	Substation/connection to grid
<b>2</b>	Wind power plant
<b>3</b>	Couplings due to lightning currents

Lightning and surge protection measures in wind power plants

### 3.2.4.2 Wind power plants

According to IEC 62305, lightning discharges can produce surge currents of up to several hundred kA. The large impulse currents produced, with their rapid rise times, generate a magnetic field that changes over time and which spreads outwards concentrically from the lightning channel. This magnetic field can penetrate the conductor loops of power and IT systems within a wind power plant. The mutual inductances, *M*, that form, can induce large surge voltages which can disrupt or even destroy electronic components. This process is based on the law of induction and can be represented as follows:

*M* is the mutual inductance of the conductor loop. The larger the surface area, and the faster the rise time of the lightning current, the greater the coupled surge voltage will be.

$$u = M \times \frac{di}{dt}$$

<i>M</i>	Mutual inductance
<i>di/dt</i>	Current change/time

### Protection measures in energy technology systems

A type 2 surge arrester is essential for protecting sensitive electronic components within the wind power plant. However, VDE 0100-534 states that certain technical requirements must be met for these arrestors to be used; these are described in further detail below. A basic requirement of wind power plant operators is that the electronic supply system is executed in such a way as to comply at all times with EMC (electromagnetic compatibility) requirements so as to prevent interference currents on cable shields and PE. Different power networks and voltages can be encountered in wind power plants: 230/400 V and 400/690 V. Particularly in 400/690 V networks, special requirements relating to surge voltage protection must be observed.

### Taking account of the sensors in wind power plants

The latest wind power plants use so-called pitch controls. Lightning and surge protection is required to protect the electronic controls and speed control against failure.

### Recommended installation locations in wind power plants

Because the coupled surge voltage is always at both ends of the cable, each device inside the structure must be protected. Because, particularly in large wind power plants, long cable lengths with large surface areas are not uncommon, a surge protection device (SPD) should be fitted immediately before each of the sensitive devices within the bus. In areas of high humidity and low temperatures, the sensor can freeze, which can impair the measurement signal. Most sensors used in locations of this kind are fitted with a heating system. These sensors need an SPD that is designed to withstand not just the measurement signal itself, but also large nominal load currents. OBO Bettermann offers a space-efficient solution: the MDP. Despite its small installation width, this high-performance surge arrester developed for use in wind power plants is suitable for the high requirements of large nominal load currents of up to 10 A. This enables it to protect even high-bandwidth sensors simply yet effectively.

### 3.2.4.3 Residential and industrial applications

Transient surges resulting from lightning strikes and switching operations cause the failure and destruction of electronic devices. Damage to terminal devices in homes and the failure of computer-controlled systems in everything from industry and commerce to agriculture, lead to downtimes, costly repairs or even the loss of important files such as documents, photographs and customer enquiries and orders. Surge protection measures should be taken for the following devices and systems:

#### Antenna systems

- Cable connection
- Antennas
- E.g. TVs, videos and DVD recorders, stereos

#### Telephone systems

- Analogue
- ISDN NTBA
- IP telephony systems

#### Construction engineering/installations

- Heating controls
- Solar and photovoltaic systems
- Building automation

#### Terminals

- Computer
- Household appliances, burglar alarm systems, etc.

Using surge protection devices reduces downtimes of devices and systems.

### 3.2.4.4 PV systems

Surge voltages can lead to the failure of PV systems and hence failure to achieve the expected yields. To prevent loss of investments, relevant insurance-related questions need to be considered. Only a protected system can withstand these loads and reliably produce electricity. Under VdS Directive 2010, property insurers require PV systems of 10 kWp or more to be fitted with lightning protection and internal surge voltage protection.

If a new PV system is connected to an electrical system, surge protection (type 2) on the AC side is required according to IEC 60364-4-44 and 60364-7-712. The German Supplementary Sheet 5 of the lightning protection standard IEC 62305-3 also requires – to protect the inverter – the installation of surge protection on the DC side.

In addition, on PV systems, surge protection for information and communication technology is recommended.



House with lightning protection system and internal lightning protection system

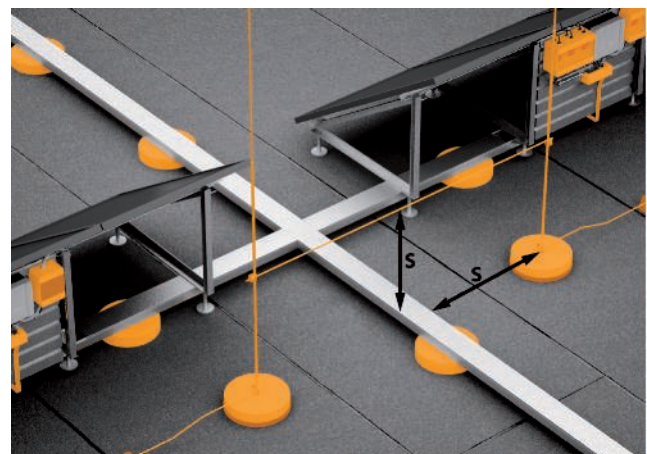

PV system in the protection area of the air-termination system situated at a separation distance of  $s$

### Avoiding shade from the lightning protection system

The position of the air-termination masts or air-termination rods should be chosen so that there is no shading of the PV modules. A core shadow can cause performance reductions of the whole string. An air-termination rod must be at least 108 x diameter from the PV module (DIN EN 62305-3 Suppl. sheet 5).

Note that the PV system must remain in the protection area of the air-termination rod.

Diameter of the air-termination system (m)	Distance between the air-termination system and the PV module (m)
0.008	0.86
0.010	1.08
0.016	1.73

Table 3.6: Minimum distance from the air-termination systems, to avoid a core shadow

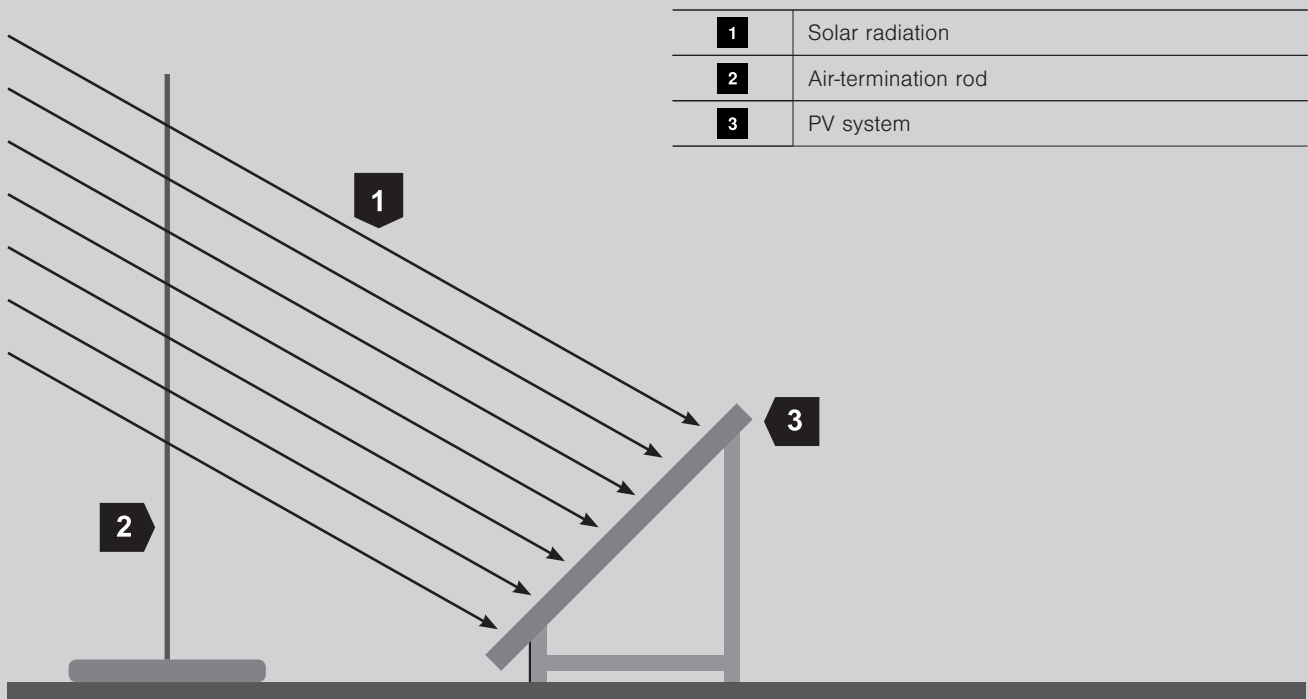

An air termination rod casting a shadow on a PV module

## Smart Home with PV system and external lightning protection system

In this building type, we will show you the following application examples\*:



- **Power supply**
  - Supply, converters, terminals
- **Telephone and communication technology**
  - TV reception technology, intercom system
- **Building and control technologies**
  - KNX, external gate control

\* Please note that the examples shown on this page are only an excerpt of the necessary protection measures for this building. For additional surge protection solutions, please refer to the surge protection selection aid, which is available for download at [www.obo-bettermann.com](http://www.obo-bettermann.com)





### Power supply

#### Supply



	Protection of	Installation location	Product	Item no.
	Power supply Supply	Main distributor	V50-3+NPE-280	5093 526
	Power supply Supply	Sub-distributor, spacing > 10 m	V10 Compact AS	5093391

#### Photovoltaics

	Protection of	Installation location	Product	Item no.
	PV AC side	Directly on the power inverter	V20-3+NPE	5095253
	PV DC side, per tracker, up to 1,000 V	Directly on the power inverter	V20-C 3-PH-1000	5094608



## Power supply

## Terminal protection

	Protection of	Installation location	Product	Item no.
	PC, power supply	On the PC	FC-D	5092800
	Additional sensitive devices (e.g. food processor)	On the device	ÜSM-A-2	5092460



## TV reception technology

## Sat system

	Protection of	Installation location	Product	Item no.
	TV device	On the TV	FC-SAT-D	5092816
	Sat protection	On the Multiswitch (roof)	TV4+1	5083400
	Sat protection Power supply	On the Multiswitch (roof)	FC-D	5092800



## Telephone and communication technology

## Intercom system



	Protection of	Installation location	Product	Item no.
	Control of an external intercom system, power supply	On the intercom system and in the building	V50-1+NPE-280	5093522
	Control of an external intercom system, data cable	On the intercom system and in the building	TKS-B	5097976

## Building and control technologies

## KNX











	Protection of	Installation location	Product	Item no.
	KNX building controller 24 V data cable	Directly on the hat rail, on the control device	FRD24	5098514
	KNX control unit, permanently integrated	In the connection socket	ÜSM-A	5092451









## External gate control



























	Protection of	Installation location	Product	Item no.
	Controller External gate Power supply	On the gate + in the building	V50-1+NPE-280	5093522
	Controller External gate Data cable	On the gate + in the building	TKS-B	5097976

Selection aid, energy technology

AC combination arrester and surge protection; type 1, type 1+2, type 2 and type 3







		Installation location 1 Installation in the main distributor box / combined distributor Basic protection / type 1, type 2				
Initial situation	Building type	Description	Type	Item no.	Test mark	Product figure
No external lightning protection system Earthing cable connection 	Private building, Multiple dwelling, industry, commerce	TN-/TT Type 2 4 Division Secondary counter zone	V20 3+NPE	<b>5095253</b>	VDE ÖVE UL	
			V20 3+NPE+FS with remote signalling	<b>5095333</b>	VDE ÖVE UL	
	Private building, Multiple dwelling	TN-/TT Type 1 + 2 40 mm busbar Power connection compartment (NAR)	MCF25-NAR-TNC	<b>5096950</b>	VDE	
			MCF30-NAR-TT	<b>5096961</b>	VDE	
External lightning protection system (according to IEC 62305) 	Buildings of lightning protection classes III and IV (e.g. housing, offices and commercial buildings)	TN-/TT Type 1 + 2 4 Division Secondary counter zone	V50 3+NPE	<b>5093526</b>	VDE ÖVE UL	
			V50 3+NPE+FS with remote signalling	<b>5093533</b>	VDE ÖVE UL	
Outdoor connection 	Buildings of lightning protection classes I to IV (e.g. industry)	TN-C Type 1 6 Division Pre-metered or secondary counter zone	MCF75-3+FS	<b>5096981</b>	VDE UL	
		TN-S Type 1 40 mm busbar Power connection compartment (NAR)	MCF75-NAR-TNC	<b>5096982</b>	VDE	
		TN-S Type 1+2 6 Division Pre-metered or secondary counter zone	MCF100-3+NPE+FS	<b>5096987</b>	VDE UL	
		TN-S/TT Type 1+2 40 mm busbar Power connection compartment (NAR)	MCF100-NAR-TT	<b>5096985</b>	VDE	

Installation location 2 Installation in the sub-distributor Medium protection/type 2 Only required if distance $\geq 10$ m				
Description	Type	Item no.	Test mark	Product figure
TN/TT Type 2 + 3 2.5 Division	V10 Compact	<b>5093380</b>		
	V10 Compact FS, with remote signalling	<b>5093382</b>		
TN/TT Type 2 4 Division	V20 3+NPE	<b>5095253</b>	VDE ÖVE UL	
	V20 3+NPE+FS with remote signalling	<b>5095333</b>	VDE ÖVE UL	
TN/TT Type 2 4 Division	V20 3+NPE	<b>5095253</b>	VDE ÖVE UL	
	V20 3+NPE+FS with remote signalling	<b>5095333</b>	VDE ÖVE UL	
TN/TT Type 2 4 Division	V20 3+NPE	<b>5095253</b>	VDE ÖVE UL	
	V20 3+NPE+FS with remote signalling	<b>5095333</b>	VDE ÖVE UL	

Installation location 2 Installation before the terminal Fine protection/type 3				
Description	Type	Item no.	Product figure	Product figure
Plug-in	FC-D	<b>5092800</b>		
	FC-TV-D	<b>5092808</b>		
	FS-SAT-D	<b>5092816</b>		
	FC-TAE-D	<b>5092824</b>		
	FC-ISDN-D	<b>5092812</b>		
	FC-RJ-D	<b>5092828</b>		
	CNS-3-D-D	<b>5092701</b>		
Fixed installation	ÜSM-A	<b>5092451</b>		
	ÜSM-A ST-230 1P+PE	<b>5092441</b>		
	ÜSS 45-o-RW	<b>6117473</b>		
Series installation in distributor	V10 Compact L1/L2/L3/N	<b>5093380</b>		
	VF230-AC/DC	<b>5097650</b>		
	VF230-AC-FS with remote signalling	<b>5097858</b>		

TBS Blitzschutz-Leitfaden 2018 / en / 2020/01/10 14:42:40 / 2020/01/10 14:42:40 (LLExploit\_02613) / 2020/01/10 14:42:54 14:42:54













## Selection aid Photovoltaic system solutions





Energy technology, type 2, protection of the DC side								
Initial situation	Max. DC voltage	Max. number of MPP per inverter	Max. number of strings per MPP terminal	Connection (DC side)	Version	Type	Item no.	Product figure
No external lightning protection system Earthing cable connection  The following are required: Surge protection type 2 Lightning protection equipotential bonding system 6.5 mm <sup>2</sup>	1000 V	1	1In/1Out	MC 4 connector		VG-C DCPH-Y1000	<b>5088 67 2</b>	
		1	2	Terminals	Circuit breaker	VG-C DC-TS1000	<b>5088 66 0</b>	
		1	4	Terminals	4 fuse holders, unequipped	VG-C PV1000KS4	<b>5088 65 4</b>	
		1	1 0	Terminals		VG-C DCPH-MS1000	<b>5088 69 1</b>	
		2	4	Terminals		VG-CPV1000K 22	<b>5088 56 8</b>	
		2	6	Terminals		VG-CPV 1000K 330	<b>5088 58 2</b>	
		3	6	Terminals		VG-CPV 1000K 333	<b>5088 58 5</b>	



You can find the selection aid for AC combination arrestors and surge protection in the chapter Surge Protection in Energy Technology.



Energy technology, type 1+2, protection of the DC side									
Initial situation	Max. DC voltage	Max. number of MPP per inverter	Max. number of strings per MPP terminal	Connection (DC side)	Version	Type	Item no.	Product figure	
External lightning protection system according to DIN EN 0185-305  The following are required: Lightning and surge protection type 1+2 Lightning protection equipotential bonding system 16 mm <sup>2</sup> Separation distance could not be maintained  	600 V	1	1 0	Terminal		VG-BC DCPH-MS600	<b>5088693</b>		
		1	1In/1Out	MC4 connector		VG-BC DCPH-Y600	<b>5088676</b>		
	900 V	1	3	Terminals			VG-V25-BC3-PH900	<b>5088591</b>	
		1	2	Terminals	Switch-disconnector		VG-BC DC-TS900	<b>5088635</b>	
		1	8	Terminals			VG-BC DCPH900-4K	<b>5088632</b>	
		1	1 0	Terminals			VG-BC DCPH-MS900	<b>5088692</b>	
		2	2In/1Out	MC4 connector			VG-BC DCPH900-21	<b>5088625</b>	
		2	4	Terminals			VG-BCPV900K 22	<b>5088566</b>	
		2	6	Terminals			VG-BCPV 900K 330	<b>5088576</b>	
		3	2In/1Out	MC4 connector			VG-BC DCPH900-31	<b>5088629</b>	
3	6	Terminals			VG-BCPV 900K 333	<b>5088579</b>			

Data technology						
Initial situation		RJ 45	Terminal	Type	Item no.	Product figure
	<ul style="list-style-type: none"> <li>No external lightning protection system</li> <li>Earthing cable connection</li> </ul>	•		ND-CAT6A/EA	<b>5081800</b>	
	<ul style="list-style-type: none"> <li>External lightning protection system (according to DIN EN 62305)</li> </ul>		•	FRD 24 HF	<b>5098575</b>	

TBS Blitzschutz-Leitfaden 2018 / en / 2020/01/10 14:42:40 (LLExpert\_02613) / 2020/01/10 14:42:54 14:42:54

## Four steps to comprehensive protection of PV systems

### Step 1:

#### Check the separation distance

If the required separation distance cannot be complied with, then the metallic parts must be interconnected to be able to carry lightning current.

### Step 2:

#### Check the protection measures

Measures for lightning protection equipotential bonding are used on the DC and the AC side, e.g. lightning current arrester (type 1).

### Step 3:









#### Include data cables

Data cables must be included in the protection concept.

### Step 4:

#### Carrying out the equipotential bonding

Local equipotential bonding must be provided on the inverter.

Overview of protection measures					
Initial situation	Measure	Separation distance according to IEC 62305 maintained	Equipotential bonding	Surge protection	Sample product picture
External lightning protection system (according to DIN EN 62305) 	Adapt the lightning protection system according to DIN EN 62305	Yes	min. 6 mm <sup>2</sup>	DC: Type 2 V20-C 3PH-1000 5094608	
				AC: Type 1+2 V50 3+NPE 5093526	
		No	min. 16 mm <sup>2</sup>	DC: Type 1+2 V-PV-T1+2-1000 5094230	
				AC: Type 1+2 V50 3+NPE 5093526	
No outside lightning protection system earthing cable connection 	Requirements testing: LBO, Vds 2010, risk analysis, ...	-	min. 6 mm <sup>2</sup>	DC: Type 2 V20-C 3PH-1000 5094608	
				AC: Type 2 V20 3+NPE 5095223	

### 3.2.4.5 LED street lighting systems



#### Damage and repair costs

In the field of street lighting, the replacement of the defective components, alongside the hardware costs, also incurs high costs through the use of elevating platforms and personnel. Upstream surge protection devices reduce the pulses and protect the luminaire. Whole streets are supplied via central distribution boxes, containing the controllers and protection components. The supply voltage is fed in via buried cables in the connection compartment of the mast. The luminaire is supplied from the connection compartment.

#### Creation of the earthing systems

In a new installation, the supply cable can be protected against destruction from lightning currents in the earth by an optional earthing line above it. According to the current lightning protection standard IEC 62305-3 German supplement 2 (VDE 0185-305-3), this earthing line must be located 0.5 metres above the supply cable. The earthing line compensates potential differences and minimises arcing to the supply cable.

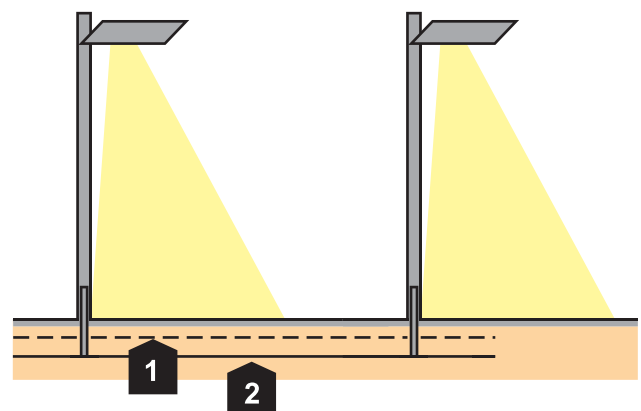

1	Earthing line, uninsulated
2	Supply cable

Cable routing

### Installation location of the lightning and surge protection

The use of surge protection is required for safe operation. According to the American ANSI and IEEE standard, a surge voltage resistance of 20 kV is required for outdoor lighting at a surge current load of 10 kA. However, of decisive importance for the protection action is that the protection level of the surge protection device is below the surge voltage resistance of the lights and the LED driver. Surge protection devices must correspond to the testing standard IEC 61643-11 and must be able to arrest surge currents of several thousand amps multiple times without destruction. According to the testing standard, each protection device must have thermal monitoring and must be isolated safely if there is a defect.

The luminaire standard "Fpr EN 60598-1: 2012-11 Luminaires – Part 1: General Requirements and Tests", Point 4.32 specifies: "Surge protection devices must meet IEC 61643."

If there is a direct lightning strike in the mast luminaire, a large portion of the lightning current will flow directly into the earth, creating a potential difference to the supply cable. Powerful lightning current / combination arrestors can arrest the energy-rich currents.

*Surge protection devices must correspond to IEC 61643.*

*(Source: Luminaires EN 60598-1)*

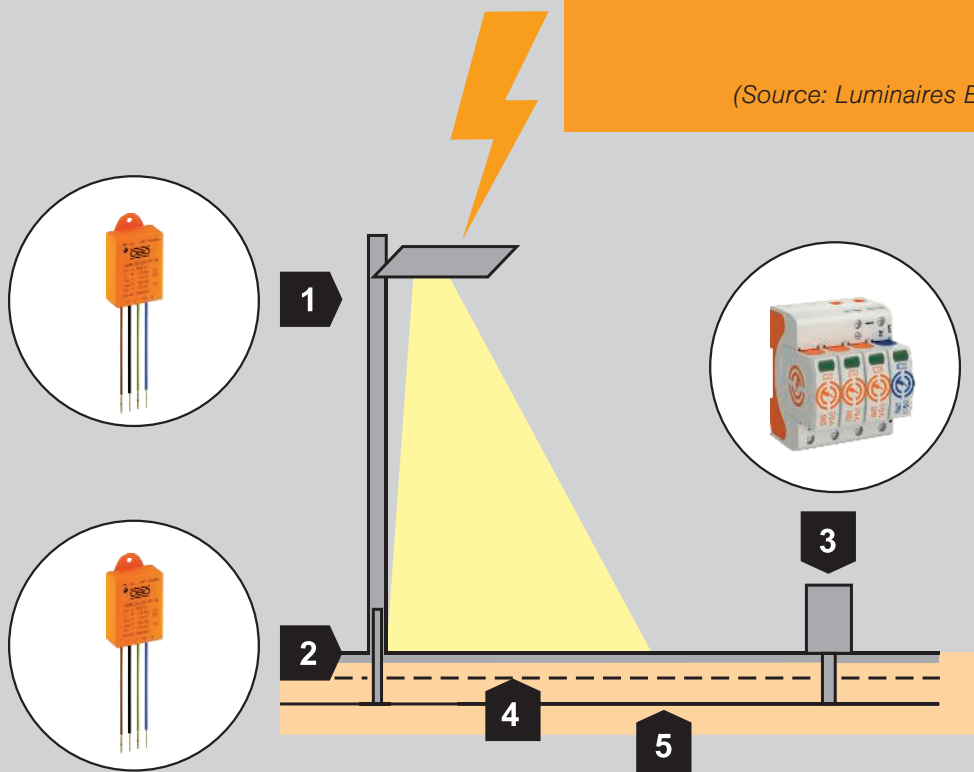

	Installation location	Description	Protection device	Item no.
1	Lamp head with LED system, before the LED driver	Surge protection type 2	ÜSM-20-230L1+PE	5092431
2	Connection compartment of the mast luminaire	Surge protection module, type 2+3	ÜSM-20-230I1P+PE	5092431
3	Control cabinet with electronics, supply	Surge protection type 1+2	V50 combination arrester	5093526
4	Earthing line, uninsulated	Flat or round conductor		5018730
5	Supply cable			

Direct lightning strike into the mast luminaire

### Remote strike and inductive coupling

A lightning strike within 1.5 km generates a surge voltage which hits the lighting via the supply cable. These surge voltages have less energy than the direct lightning strike, but can still destroy electronic components. Inductive couplings are considerably reduced through a metallic mast and a luminaire with a metallic housing. Here too, surge voltage pulses along cables from the supply network need to be considered. In this case, the surge protection in the mast connection compartment is easily accessible and easy to check.

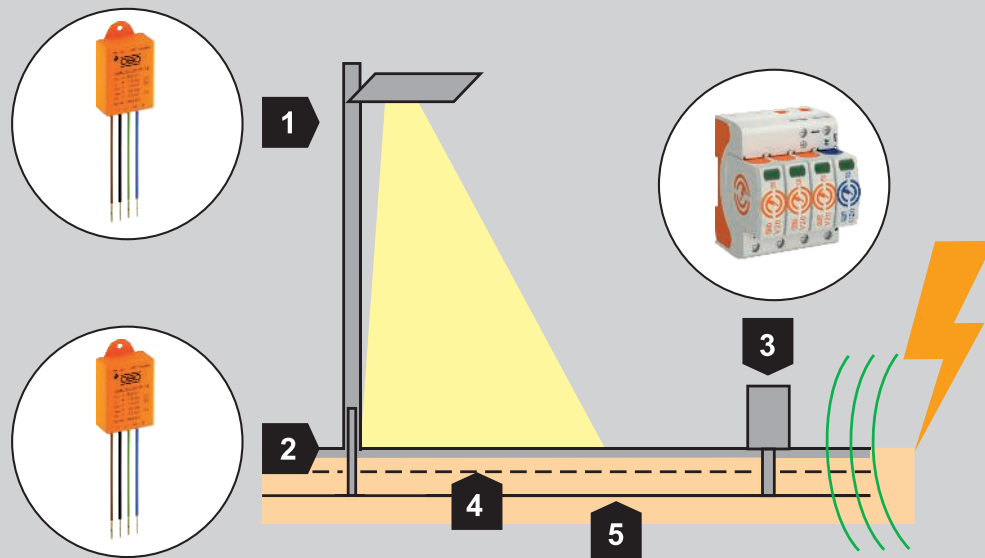

	Installation location	Description	Protection device	Item no.
1	Lamp head with LED system, before the LED driver	Surge protection type 2	ÜSM-20-230L1+PE	5092431
2	Connection compartment of the mast luminaire	Surge protection type 2+3	ÜSM-20-230L1+PE	5092431
3	Control cabinet with electronics, Supply, 3-phase	Surge protection type 2	V20 3+NPE-280	5095253
3	Alternatively: control cabinet with electronics, supply 1-phase	Surge protection type 2	V20 1+NPE-280	5095251
4	Earthing line, uninsulated	Flat or round conductor		5018730
5	Supply cable			

Remote strike and inductive coupling

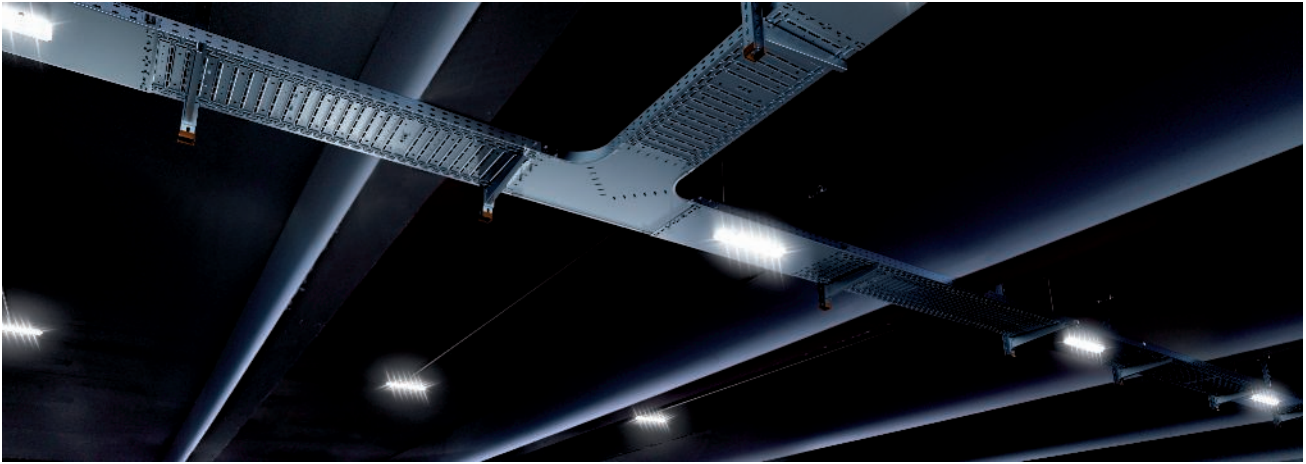

LED lighting system in an indoor car park

### 3.2.4.6 LED internal lighting in buildings and halls

LED lighting systems in industrial plants and administrative buildings are usually destroyed by high voltages, coupled inductively or by switching operations.

A risk analysis according to IEC 62305 can be used to determine whether an external lightning protection system is required or not. In a lightning protection system, the supply cables at the entrance to the building must be protected using suitable lightning current arrestors. Independently of this, the surge protection system should be installed for the entire lighting system.

In industrial and sports halls, the luminaires are installed at a great height. After damage, the lights or the LED drivers can only be repaired at a high cost. As the minimum lighting strength required at the workstation can lead to accidents or errors, immediate action is required.

The usually very long supply lines have a high potential for inductive coupling of surge voltages.

Surge protection devices must be used in the sub-distributor to be supplied. However, the luminaires are often 10 m from this distributor. To protect the LED drivers and the light, a protection device is then required directly in front of the electronic components. If the luminaires are, for example, mounted directly beneath the cable support systems, then the surge protection can also be inserted in a junction box in front of the luminaires. To use the shielding function of the metallic cable support systems, these must be included in the equipotential bonding on both sides.

#### Connection of the protection device

The protection device ÜSM-LED 230 can be installed in series with or in parallel to the luminaires. The differing connection can be used to maximise availability (parallel connection) or to switch off the luminaire if there is a defect on the protection device (serial connection).

**Parallel connection**

The surge protection device is located upstream of the LED luminaire.

**Failure behaviour:**

The display on the ÜSM-LED goes out. The surge protection is disconnected. The LED luminaire remains lit without protection.

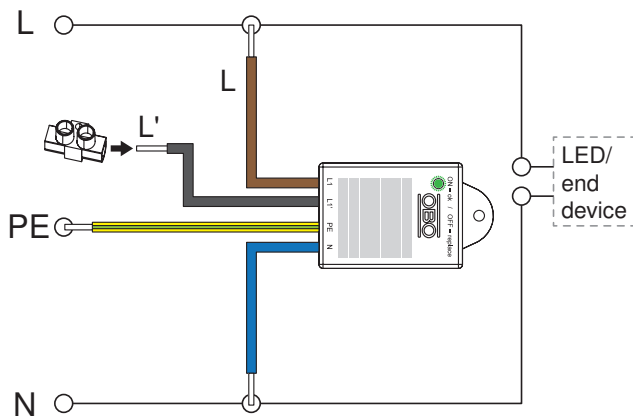

L	Phase feed line
L'	Phase from the protection device (switch-off in case of failure)
PE	Earth
N	Neutral conductor
LED	Luminaire

Parallel connection (max. availability)

**Series connection**

The surge protection is switched in series to the LED luminaire.

**Failure behaviour:**

The display on the ÜSM-LED goes out. The surge protection and the circuit (L') are disconnected. The failure is signalled by the luminaire going out. A suitable protection device upstream of the electronic LED drivers is a safe barrier against surge voltages. This guarantees the lifespan of the LED luminaires, securing the investment.

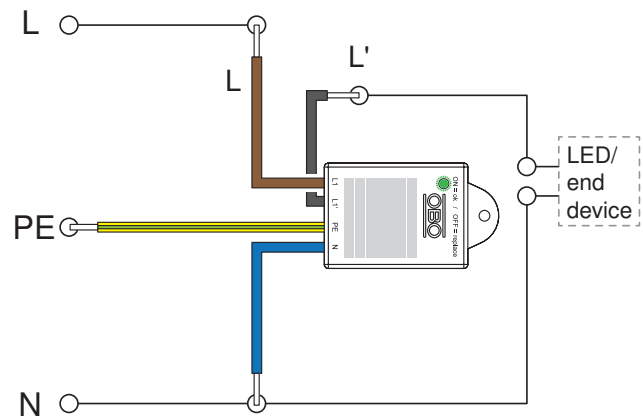

L	Phase feed line
L'	Phase from the protection device (switch-off in case of failure)
PE	Earth
N	Neutral conductor
LED	Luminaire

Series connection (luminaire goes off)

In the commercial section and in the field of street lighting, with long lifespans, enormous cost savings are possible, despite the increased procurement price. However, premature failure from surge voltage damage can push the return on investment back into the future. The investments can be protected through suitable protection measures.

<b>1</b>	Energy cable
<b>2</b>	Data cable
<b>3</b>	Equipotential bonding

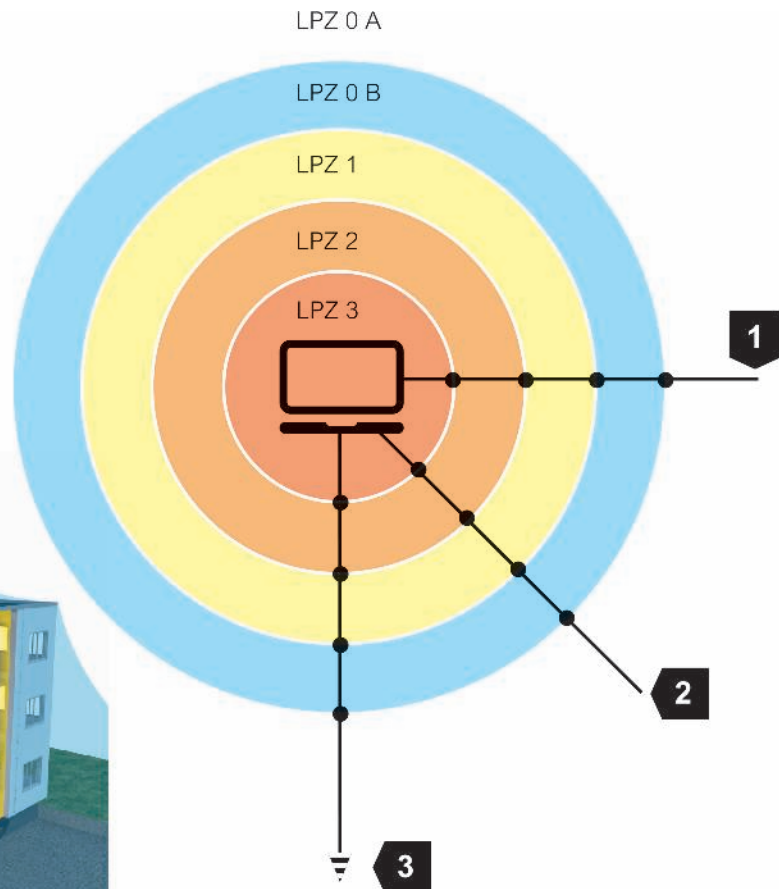
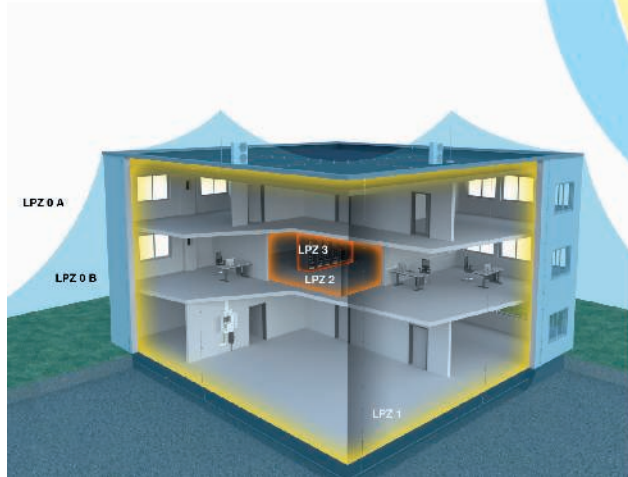

Protection principle based on lightning protection zone concept

### 3.3 Surge protection systems for data and information technology

Data and information technology systems are used in many different applications. Almost every electronic system used to process information is considered extremely important. Ever increasing volumes of data are being stored and must be accessible at all times at very short notice. It has become even more important to protect these systems too against dangerous surges. In order to prevent failure or even destruction of these systems, they must be integrated into the lightning and surge protection concept.

#### 3.3.1 Planning methods

##### Basic principles

These days, communication and IT systems are the lifelines of almost every company. In the worst-case scenario, surge voltages, caused by galvanic, capacitive or inductive couplings in data cables, can destroy IT equipment and communication technology. To avoid such failures, suitable protection measures have to be taken.

To avoid such failures, suitable protection measures have to be taken.

In practice, the wide range of standard information, telecommunication and measurement systems often makes the selection of the right surge protection device complex. The following factors must be taken into account:

- The connection system of the protection device must fit the device to be protected.
- Parameters such as the highest signal level, highest frequency, maximum protection level and the installation environment must be taken into account.
- The protection device may only exert the minimum of impacts, such as attenuation and reflection, on the transmission path.



### Protection principle

A device is only protected against surge voltages if all energy and data cables connected to the device are integrated into the equipotential bonding system at the lightning protection zone transitions (local equipotential bonding). OBO Bettermann offers a complete range of tried-and-tested, highly functional and reliable data cable protection devices for all standard telecommunication and information technology systems.

### Standards in data and information technology

Various standards have a role in the field of data and telecommunications technology. From structured building cabling through equipotential bonding up to EMC, various different standards must be taken into account. Some important standards are listed here.

Standard	Contents
IEC 61643-21	Low-voltage surge protective devices – Part 21: Surge protective devices connected to telecommunications and signalling networks. Performance requirements and testing method.
IEC 61643-22	Low-voltage surge protective devices – Part 22: Surge protective devices connected to telecommunications and signalling networks. Selection and application principles
DIN EN 50173-1	Information technology – Generic cabling systems – Part 1: General requirements.
DIN VDE 0845-1	Protection of telecommunication systems against lightning, electrostatic discharges and surge voltages from electric power installations; provisions against surge voltages.
DIN VDE 0845-2	Protection of data processing and telecommunications equipment against the impact of lightning, discharge of static electricity and surge voltages from heavy current systems – Requirements and tests of surge voltage protection devices.
DIN EN 50310	Application of equipotential bonding and earthing in buildings with information technology equipment.
EN 61000-4-5	Electromagnetic Compatibility (EMC) – Part 4-5: Testing and measurement techniques – Surge immunity test.
EN 60728-11	Cable networks for television signals, sound signals and interactive services – Part 11: Safety (IEC 60728-11:2005).

Table 3.7: Standards referring to surge protection in information technology

### Comparison

Like the surge protective devices used in the field of energy technology, data cable protection devices are also categorised by class. Here too, the classes correspond to the lightning protection zones.

	Surge protection Energy technology	Surge protection Data cable protection
IEC testing standard	IEC 61643-11	IEC 61643-21
IEC application principles	IEC 61643-12	IEC 61643-22
LPZ 0B/1 (10/350 µs)	Class I	Class D1
LPZ 1/2 (8/20 µs)	Class II	Class C2
LPZ 2/3 (8/20 µs)	Class III	Class C2/C1

Table 3.8: Comparison of standards for surge protection devices

### 3.3.1.1 Topologies

In information technology, devices communicate with one another electrically via cables that can be arranged in various configurations; these configurations are called “topologies”. The surge protection concept selected must take account of the system topology. The most common topologies are presented below, along with information on where to position the surge protective devices in each case.

#### Bus topology

In a bus topology, all users are connected in parallel. At its end, the bus must have an anechoic closure. Typical applications are 10Base2, 10Base5 and machine controllers such as Profibus and telecommunication systems such as ISDN.

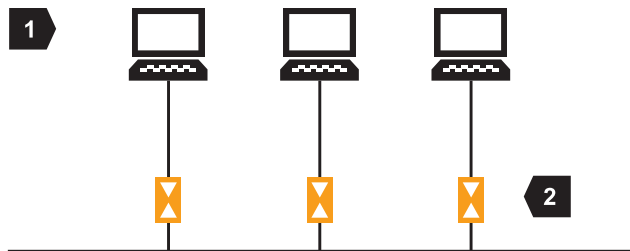

1	IT terminals
2	Surge protective devices

Bus topology

#### Star topology

In the star topology, every workstation is supplied by a separate cable from a central star point (HUB or Switch). Typical applications include 10BaseT and 100BaseT, but also 10 Gbit applications.

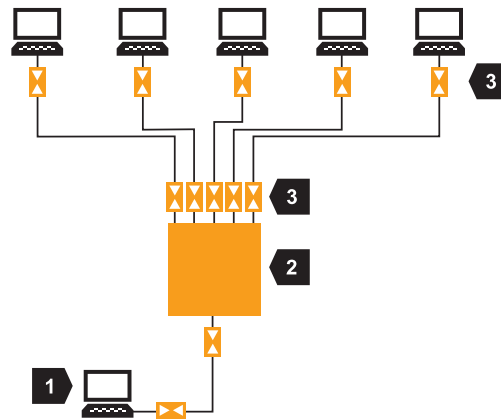

1	Server
2	Switch/Hub
3	Surge protection devices

Star topology

#### Ring topology

In a ring topology, every workstation is connected to precisely one predecessor and one successor via a ring-shaped network. If one station fails, the entire network fails. Ring networks are used e.g. in Token Ring applications.

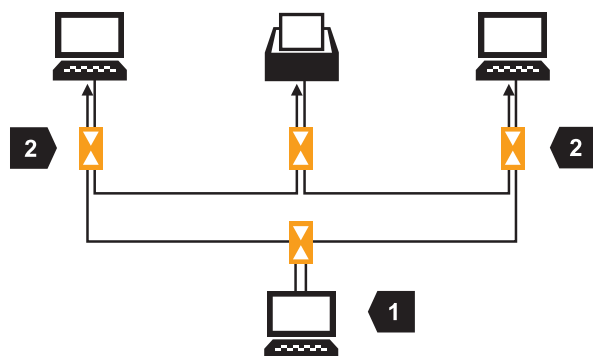

1	Server
2	Surge protective devices

Ring topology

### 3.3.1.2 Interference in information technology systems

Lightning currents and surge voltages can be coupled into data cables in different ways. Transients and lightning currents can be transmitted by the lightning directly, or via cables in which interference factors are already coupled.

Because surge voltages can occur even without lightning, for example due to switching operations in the supply network, terminal devices and cables always need to have a certain amount of voltage resistance to enable the device or cable to remain in operation following a brief surge voltage. The following table shows typical voltage resistance values for common terminal devices/cables.

*Electrical components have a specific voltage resistance.*

Application	Typical voltage resistance	OBO surge protection level
Telecoms terminals/devices	1.5 kV	< 600 V
Measurement/control terminals	1 kV	< 600 V
Telephone device cable (star quad) <ul style="list-style-type: none"> <li>• Wire-wire</li> <li>• Wire-shield</li> </ul>	0.5 kV 2 kV	< 300 V < 300 V
Installation cable – telecommunication systems (F-vYAY) <ul style="list-style-type: none"> <li>• Wire-wire</li> <li>• Wire-shield</li> </ul>	0.5 kV 2 kV	< 60 V < 800 V
Installation cable – tube wire – intercoms <ul style="list-style-type: none"> <li>• Wire-wire</li> <li>• Wire-shield</li> </ul>	1 kV 1 kV	< 60 V < 600 V
CAT7 cable <ul style="list-style-type: none"> <li>• Wire-wire</li> <li>• Wire-shield</li> </ul>	2.5 kV 2.5 kV	<120 V <700 V
Installation data cable – J-Y(ST)Y <ul style="list-style-type: none"> <li>• Wire-wire</li> <li>• Wire-shield</li> </ul>	0.5 kV 2 kV	< 60 V < 800 V
Jumper wire – telecoms distribution board	2.5 kV	< 1 kV
Profibus cable	1.5 kV	< 800 V
50 Ohm coaxial cable	2 kV - 10 kV	< 800 V
75 Ohm SAT coaxial cable	2 kV	< 800 V
J YY BMK (JB-YY) fire alarm cable <ul style="list-style-type: none"> <li>• Wire-wire</li> <li>• Wire-shield</li> </ul>	0.8 kV 0.8 kV	< 60 V < 600 V

Table 3.9: Voltage resistance of IT components

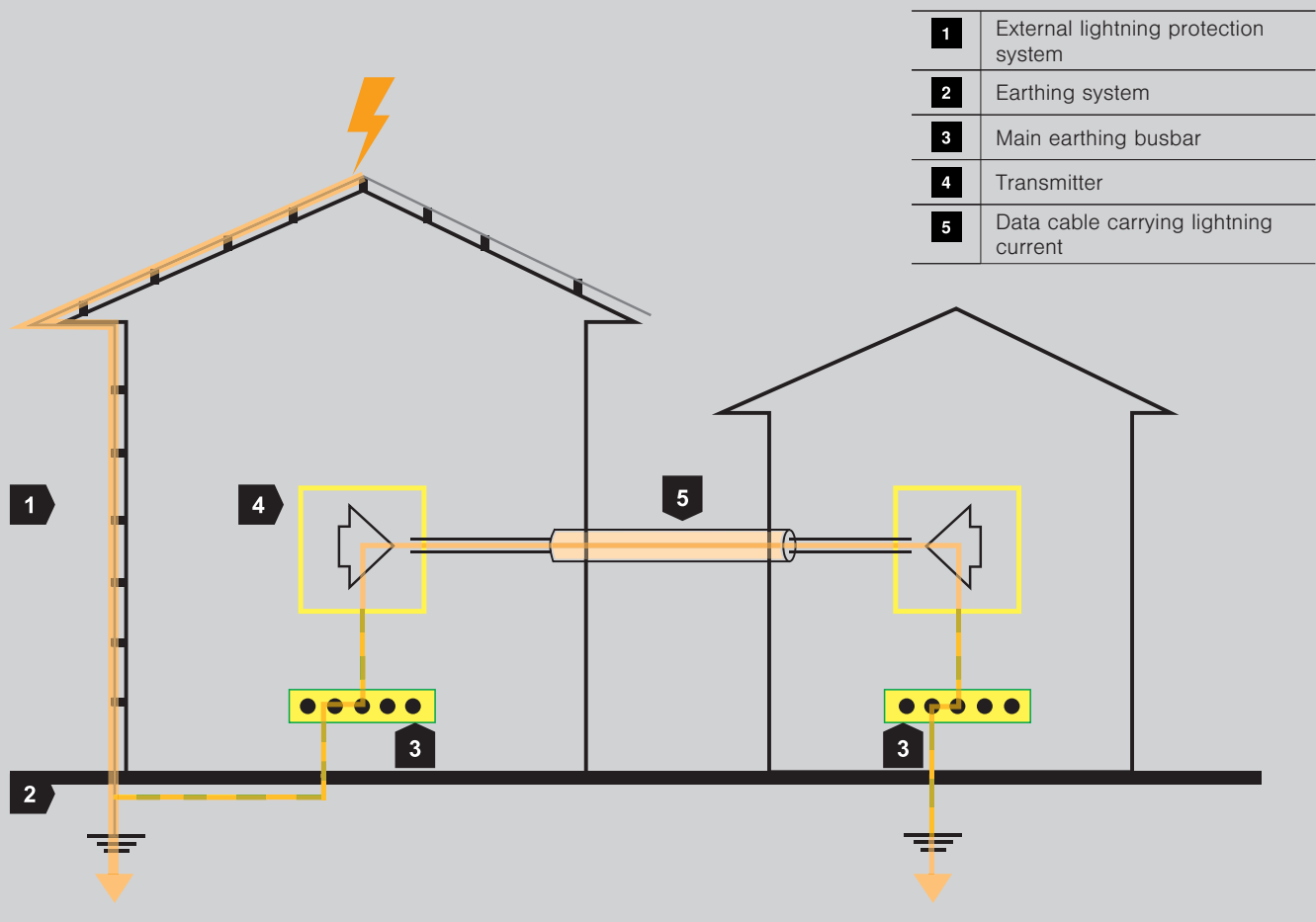

Galvanic coupling into a data cable via the external lightning protection system

**"Galvanic coupling"**

When a lightning current, e.g. in the case of a lightning strike, passes into the cable directly, this is known as galvanic coupling.

If lightning strikes and the lightning current flows into an air-termination rod and to earth via the external lightning protection system, approximately 50% of the lightning current enters the building via the building's equipotential bonding system and hence couples galvanically.

Coupled lightning currents are not always due to the external lightning protection system: In principle, any external cable that ends in the house can couple lightning currents, for example, a strike in a substation or an exposed cable connected to the house. Lightning current can also enter the building via the telecommunications cable. A metal rodent guard can turn even an EMC-insensitive fibre optic cable into a conductor of lightning current.

Surge protection devices conduct the lightning current in the incoming cables towards earth via the equipotential bonding system.

The coupled lightning current has high energy and a high frequency. Due to the curve with waveform  $10/350 \mu\text{s}$ , this type of coupling is short in duration.

It should be ensured that all supposed protection elements on cables entering the building, such as shields, rodent guards, etc., are connected to the equipotential bonding system in such a way as to carry lightning current.



<b>1</b>	Telecommunications line
----------	-------------------------

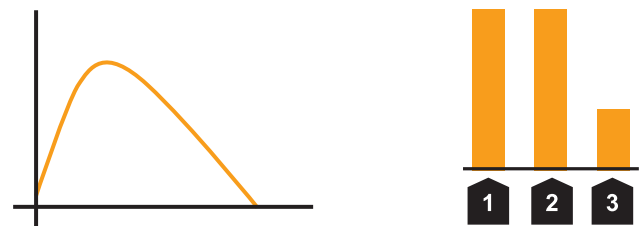

<b>1</b>	Power
<b>2</b>	Frequency
<b>3</b>	Time

*Characteristics of galvanic coupling*

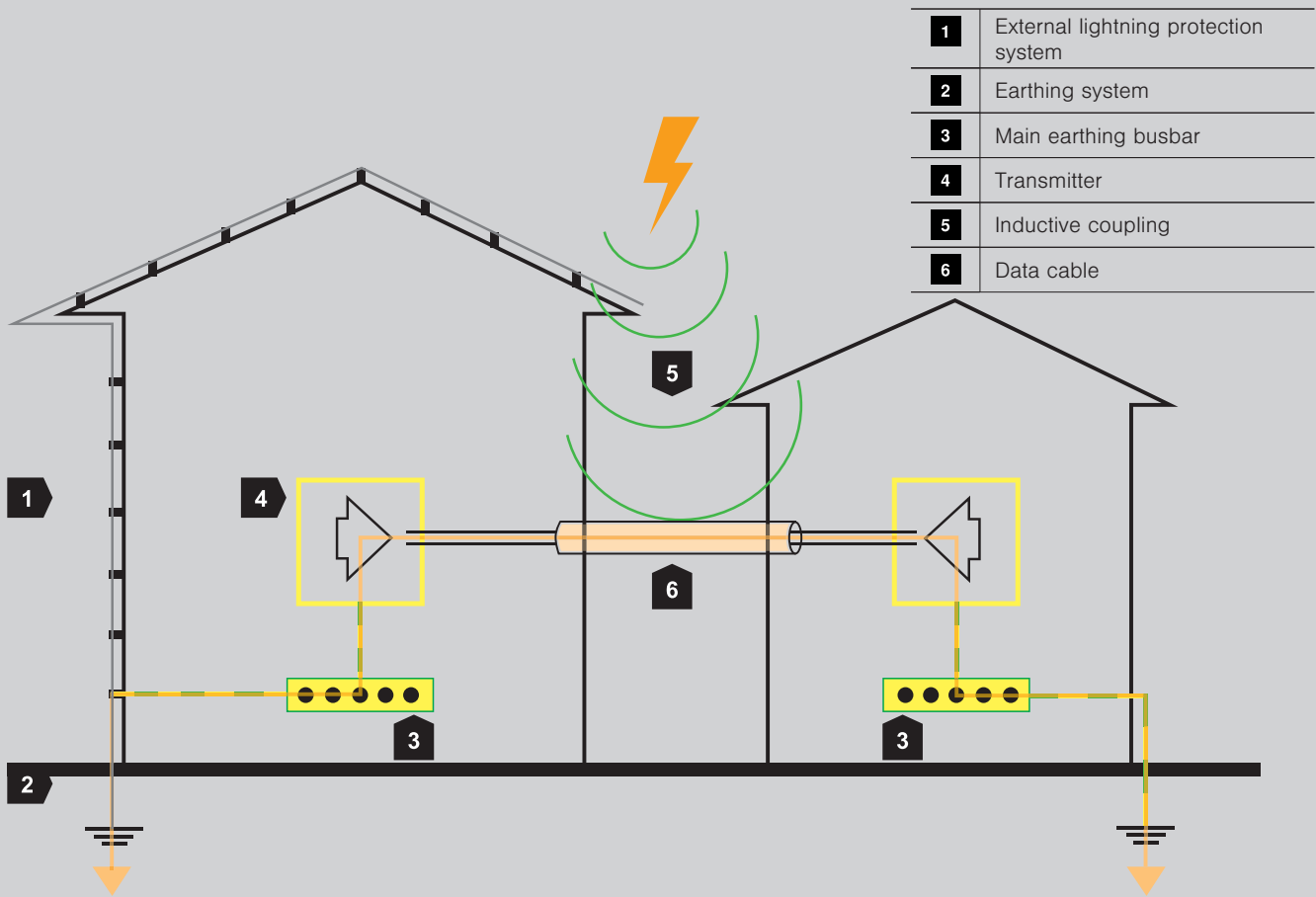

Inductive coupling in the case of a direct strike

**"Inductive coupling"**

A conductor carrying current creates a magnetic field around itself. If the lightning current is strong, the magnetic field is correspondingly larger and can couple into conductors or conductor loops located suitably nearby. Remote lightning strikes also emit electromagnetic waves that can couple into conductor loops.

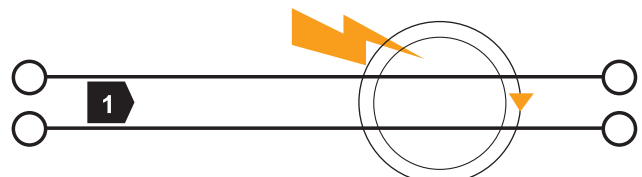

1	Data cable
---	------------

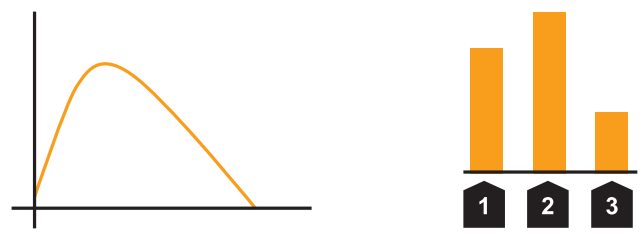

1	Power
2	Frequency
3	Time

Inductive coupling resulting from a lightning strike

This induces a surge voltage that can disrupt or damage connected electrical devices. In a data cable, this often results in the destruction of the sensitive electronic components connected to it. As with lightning current, it can be assumed that the frequency will be high and the pulse duration short. The induced surge voltages have the waveform 8/20  $\mu$ s. The energy level is lower than in the case of the 10/350  $\mu$ s pulse.

However, it is not only lightning current that can induce interference voltages; any electrical cable carrying current can do this. For example, 230 V power lines:

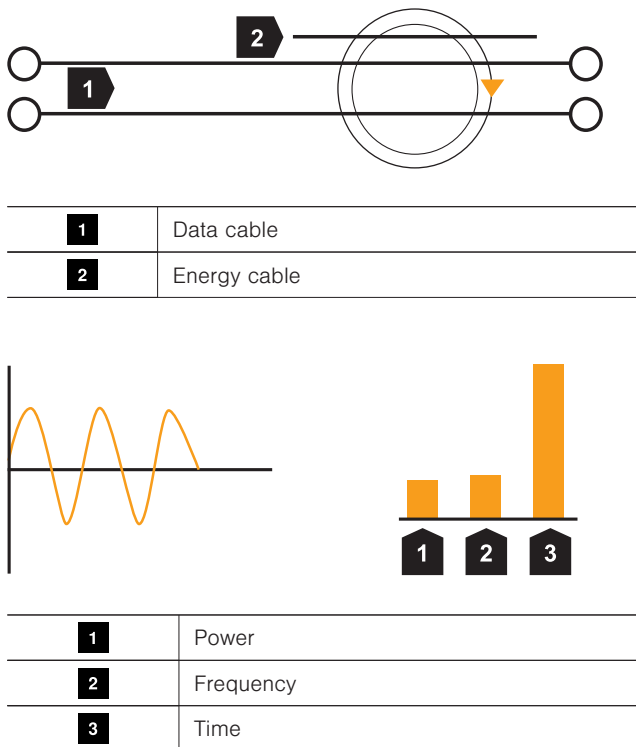

Inductive coupling from a parallel power cable

If the communication cable is located inside the magnetic field of an electrical conductor, an interference voltage can be induced. The magnitude of the interference voltage induced on the communication cable depends on both the conductor of the magnetic field, and the structure of the communication cable. A shield on the communication cable can considerably reduce the magnitude of the interference induced.

**Basic principle of induction:**

Current (I) flowing through an electrical conductor generates a magnetic field all around it. If an electrical conductor is formed into a loop and placed in a variable magnetic field, a voltage (U) can be measured at the ends of the conductor. The magnitude of the induced voltage varies depending on the size of the magnetic field and of the conductor loop inside the magnetic field.

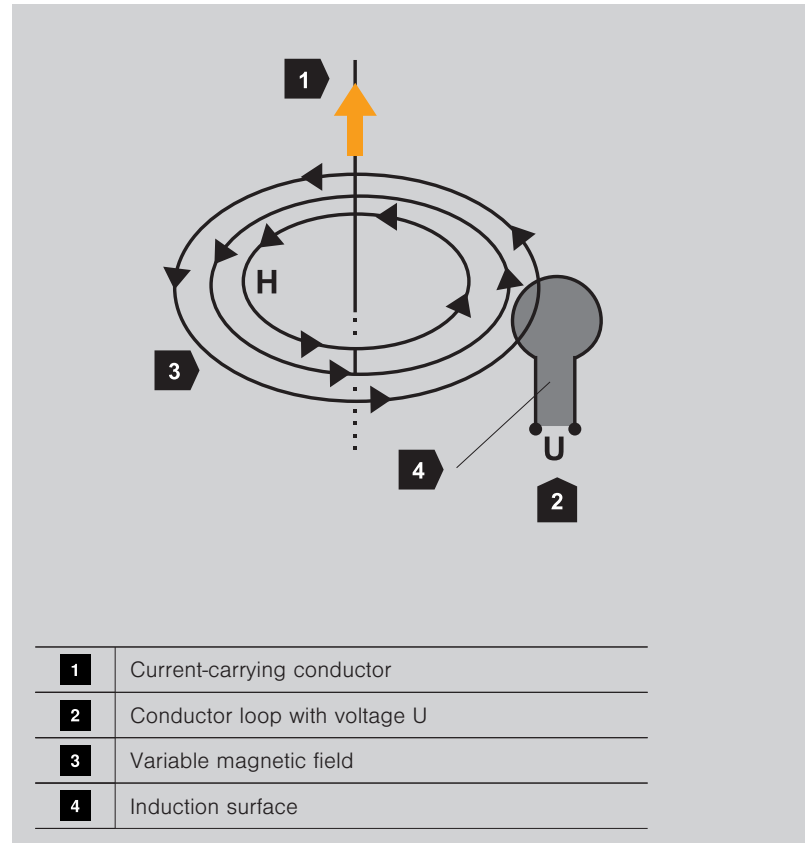

Induction in a conductor loop

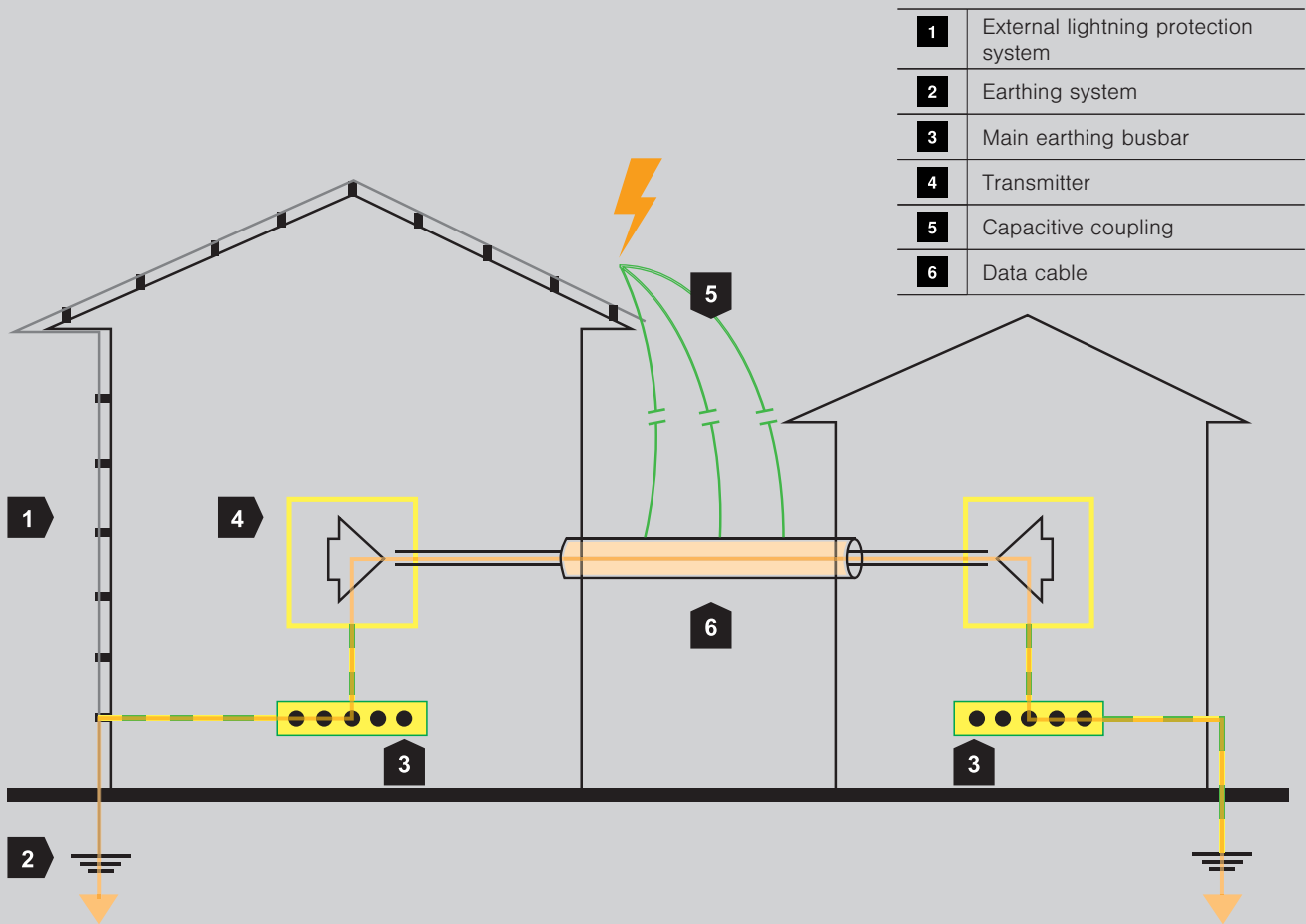

Capacitive coupling due to a direct lightning strike

**"Capacitive coupling"**

Capacitive coupling occurs where there is a voltage between two points with a high difference in potential. Charge is transferred through the medium between the two points in an attempt to even out the potentials; this creates a surge voltage.

**3.3.1.3 Building and area shielding**

Critical infrastructures such as data centres, power stations, chemical plants and electricity and water supply systems can be protected from the effects of electromagnetic waves by creating shielded areas.

This is done by covering all walls, the ceiling and the floor with conductive materials (e.g. sheet steels or copper foils). Doors and windows must be connected with the wall shielding via spring contacts. All cable glands must also be shielded.





Mobile telecommunications mast

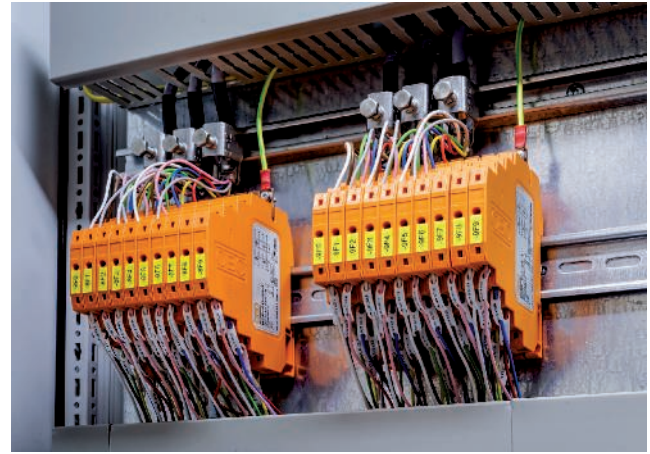

SAS clamp clip to connect the shielding braid with MDP surge protection devices

### 3.3.1.4 Cable shielding

Cables are shielded with foil or braided shields, or combinations of the two. Foil shields are particularly effective at high frequencies, whereas braided shields are better suited to low frequencies. The measure of shielding quality is shown by the shielding attenuation or shielding level. Existing cables can also be shielded using earthed cable support or metal pipe systems. In recent years, the use of electronic circuits has increased continually. Whether in industrial systems, medicine, households, telecommunications systems or electrical building installations – everywhere there are powerful electrical equipment and systems, which switch ever greater currents, achieve greater radio ranges and transport ever more energy in smaller spaces.

If, for technical reasons, e.g. in order to prevent 50 Hz ground loops, a direct connection of the cable shield at both ends is not possible, one end should be earthed directly and the other indirectly. By creating an indirect earth connection via a gas-discharge protector, in normal operation, the cable shield is insulated at one end. If a large coupling occurs, the potentials can be equalised through the ignited gas-discharge protector.

However, the use of state-of-the-art technology means that the complexity of applications also increases. The consequence of this is that ever more opposing influences (electromagnetic interferences) can occur from system parts and cables, causing damage and economic losses.

**Here, we talk of electromagnetic compatibility (EMC):**

Electromagnetic compatibility (EMC) is the ability of an electrical unit to function satisfactorily in its electromagnetic environment, without inappropriately influencing this environment, to which other units also belong (VDE 0870-1). In the EU, electromagnetic compatibility is dealt with by the EMC Directive 2014/30/EU. Electrical resources emit electromagnetic interferences (emission), which are picked up by other devices or units (immersion) which act as receivers (interference sink). This, in turn, means that the function of an interference sink can be severely reduced, and, in the worst-case scenario, total failure and economic losses. The interferences can then spread along cables or in the form of electromagnetic waves.

**Data cable without shield**

A systematic planning process is necessary to guarantee EMC. The interference sources must be identified and quantified. The coupling describes the spread of the interference from the interference source up to the influenced device, the interference sink. The task of EMC planning is to ensure the compatibility at the source, coupling path and sink using appropriate measures. During their daily work, planners and installation engineers are confronted with this subject on an increasingly regular basis. This means that EMC is a basic factor to be taken into consideration during the planning of installations and cabling systems.

Due to the high complexity of electromagnetic compatibility, the problems of EMC must be analysed and solved using simplifying hypotheses and models, as well as experiments and measurements.

**Cable support systems and their contribution to EMC**

Cable support systems can make an important contribution to the improvement of EMC. They are passive and can thus make a safe, long-lasting contribution to EMC. This is because cables are run within cable support systems or are shielded by them. Routing cables inside cable support systems greatly reduces the galvanic decoupling and coupling due to electrical and magnetic fields in the cables. Thus cable support systems can make a contribution to the reduction of coupling from the source to the sink. The shielding action of cable support systems can be quantified by the coupling resistance and the shield attenuation. This gives the planner important engineering parameters for cable support systems for the EMC engineering.

In distributed systems, cable lengths of several hundred metres are not uncommon. Depending on the cable type, shields can be used on data cables to protect the signal lines from interference. These should be connected to the equipotential bonding system to enable the coupled interference factors to be conducted away. The various shield types are presented below.

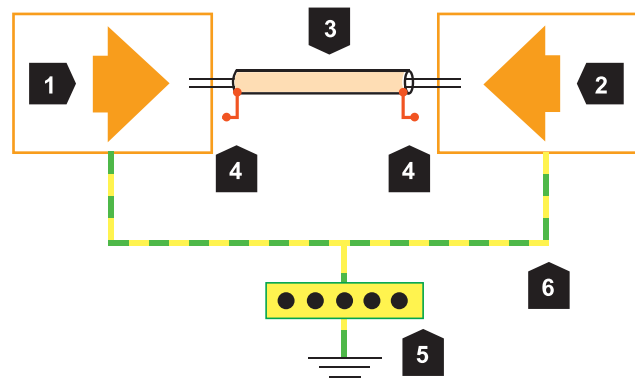

1	Device 1
2	Device 2
3	Data cable
4	Shield not connected
5	Equipotential busbar
6	Earth connection

*Cable without shield connected*

**Example:**

There is an electric field between different components in a system. The parasitic capacitances cause interference currents that affect nearby cables:

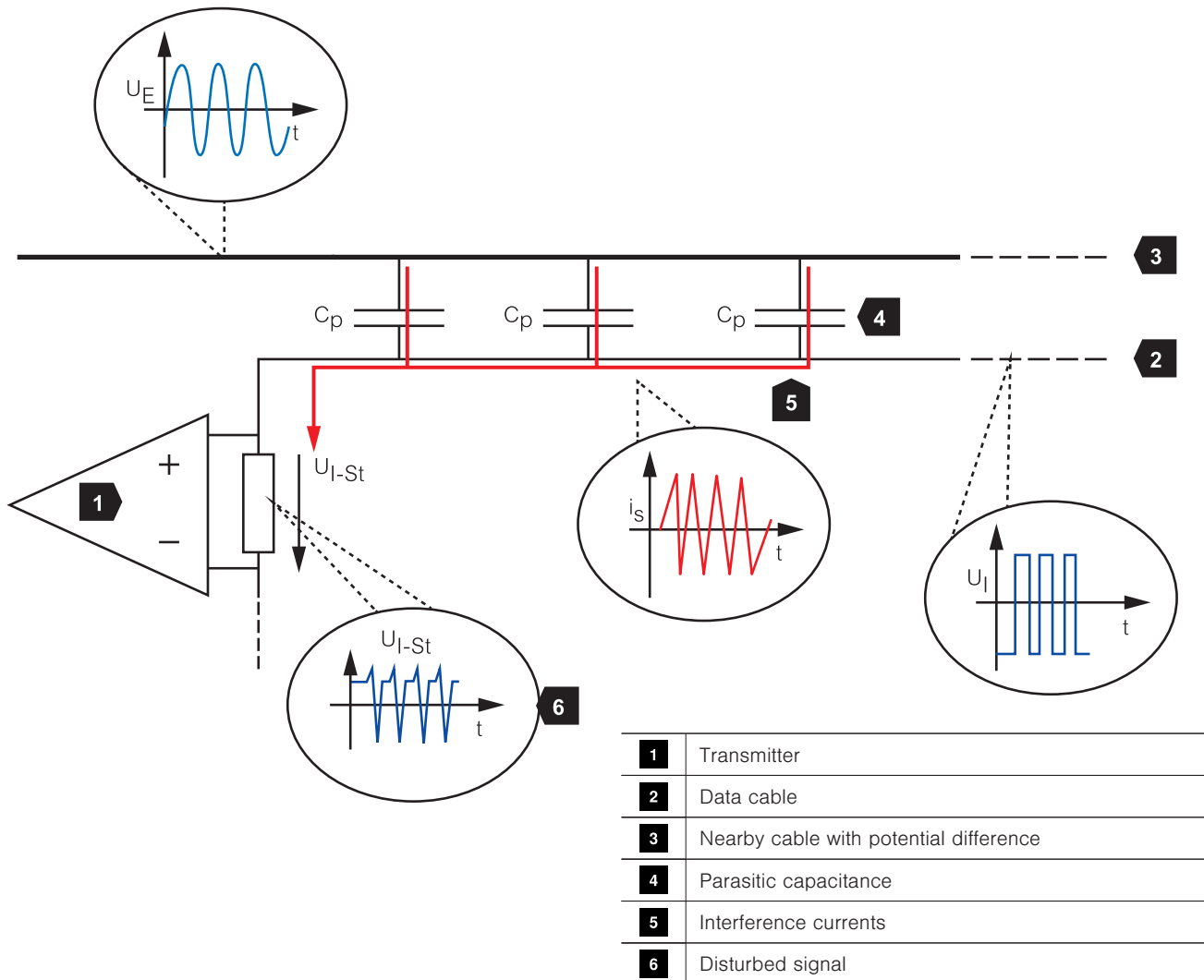

Effect of capacitive coupling on a transformer

An unconnected shield does not protect the system from the influence of interference such as:

- Crosstalk
- Inductive coupling
- Capacitive coupling

The voltages  $U_I$  and  $U_E$  relate to absolute protective earth. Due to the parasitic capacitances  $C_p$ , the current  $I_s$  flows via the transmitter to earth. The resulting interference voltage overlaps with the input voltage and disrupts signal transmission. Parasitic capacities occur for example in the HF range.

**Data cable with shield**

When laying the cable it must be ensured that the shield connection is continuous and earthed at both ends. A cable shield that is only earthed at one end is only effective against capacitive coupling. Shields that are earthed at both ends are additionally effective against inductive coupling.

The cable in the example is connected at both ends so is shielded against both capacitive and inductive coupling. Depending on the coupling resistance of the cable and the shield cross-section, the shield may be able to withstand lightning current.

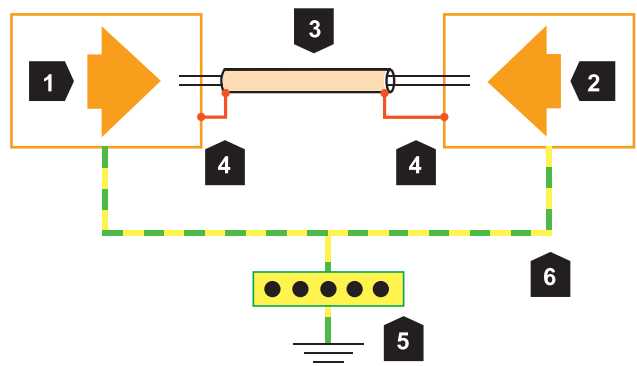

1	Device 1
2	Device 2
3	Data cable
4	Shield connected at both ends
5	Equipotential busbar
6	Earth connection

Cable shield earthed at both ends

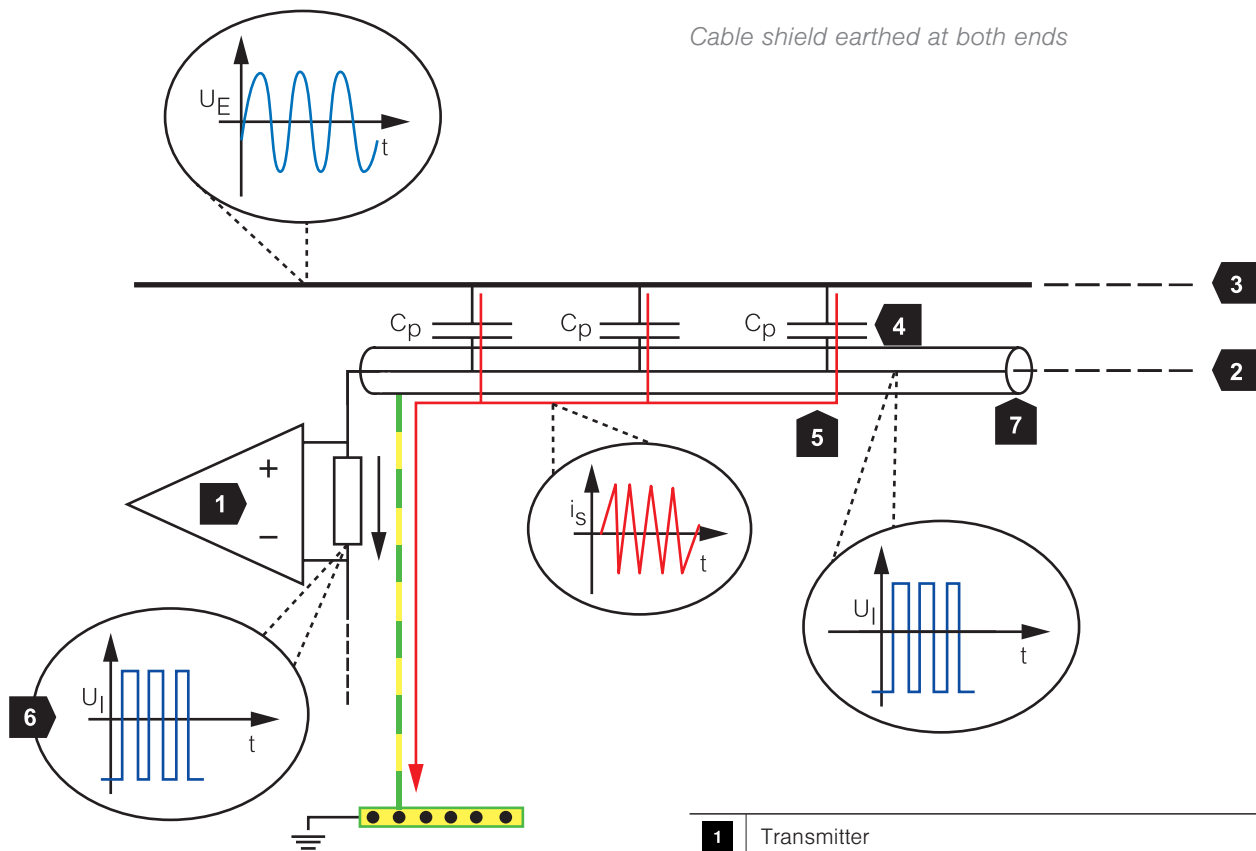

1	Transmitter
2	Data cable
3	Adjacent cable with potential difference
4	Parasitic capacitances
5	Interference currents
6	Interference-free signal
7	Shield for conducting interference currents away

Capacitive coupling onto the transmitter is prevented by the shield

Cable shields minimise interference by conducting away the currents from the parasitic capacitances.

Equalising currents are, however, still able to flow through the shield. This happens when the earth resistance is different in different earthing systems, thus creating a potential difference. As the two systems are connected via the shield, the equalising currents attempt to eliminate the potential difference. The larger the difference in potential, the greater the equalising currents. If the current is too great and the shield cannot withstand it, cable fires can occur. In TN-C networks, severe interference can also occur in the data cable.

#### Data cable with indirect earth on one side

One way of avoiding equalising currents is by earthing the shield indirectly at one end. This is done by connecting the shield to the equipotential bonding via a gas-discharge protector. Because the gas-discharge protector has a resistance of several gigaohms, there is no direct connection between the individual earthing systems. The high impedance at one end prevents equalising currents from flowing.

If the shield is impacted by lightning, the gas-discharge protector ignites. The connection at the other end has a low resistance, as it leads directly to the equipotential bonding, so the lightning current or surge voltage can be arrested at both ends. This ensures that the shield is not exposed to the full current at just one end.

#### 3.3.1.5 Transmission characteristics

Due to their sensitive signal levels, data cables are particularly susceptible to interference. This can lead to connection errors or a complete interruption of the signal. In case of interventions in the cable, for example the integration of connection sockets, plugs and adapters, or even if the bending radius is too small, it can safely be assumed that signal losses will occur. If the losses are too great, certain transmission standards will no longer be complied with. The integration of surge protection devices also counts as an intervention in the cable.

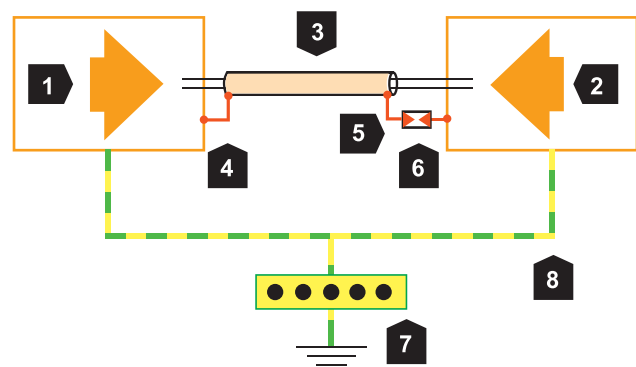

1	Device 1
2	Device 2
3	Data cable
4	Direct connection to earth
5	Indirect connection to earth
6	Gas-discharge table
7	Equipotential busbar
8	Earthing cable

*Indirect earth on one side*

To keep losses to a minimum, it is important to verify the cables' transmission characteristics.

Transmission characteristics can be determined using suitable measuring devices. What is important is that the measuring device, connection cables and surge protection device have the same impedance, in order to avoid excessive reflection and attenuation at the joints. Calibration is also necessary so that the measurement results are not distorted. Key transmission characteristics are presented below:

**Insertion loss**

Insertion loss describes the attenuation of a system from input to output. It shows the transfer function of the system and accommodates the 3 dB point.

**Return loss**

This parameter indicates in dB how much input power is reflected back. In well-matched systems, these values are around -20 dB in 50 Ω systems. If the impedances are different, reflections occur at the joint. The device no longer receives the full power available because the reflected power runs back along the line to the supply source.

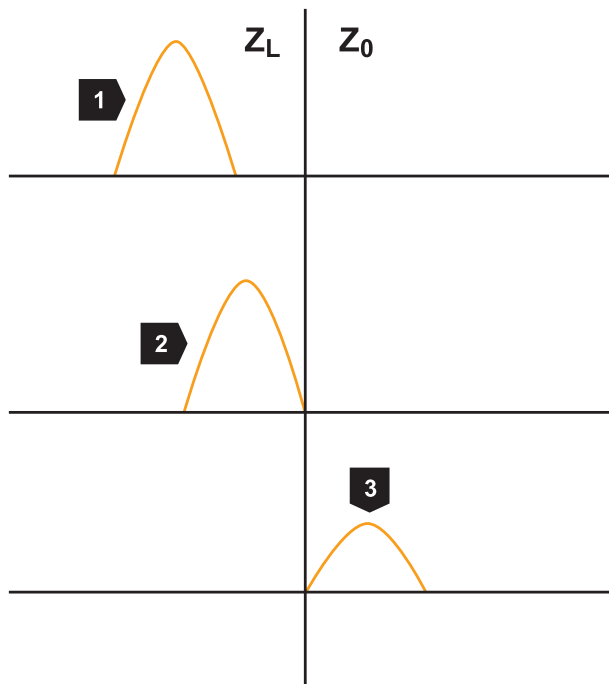

<b>1</b>	Incoming wave
<b>2</b>	Wave hits change in impedance
<b>3</b>	Wave is attenuated at the joint
$Z_L$	Impedance of the incoming cable
$Z_0$	Impedance after joint

Damped wave

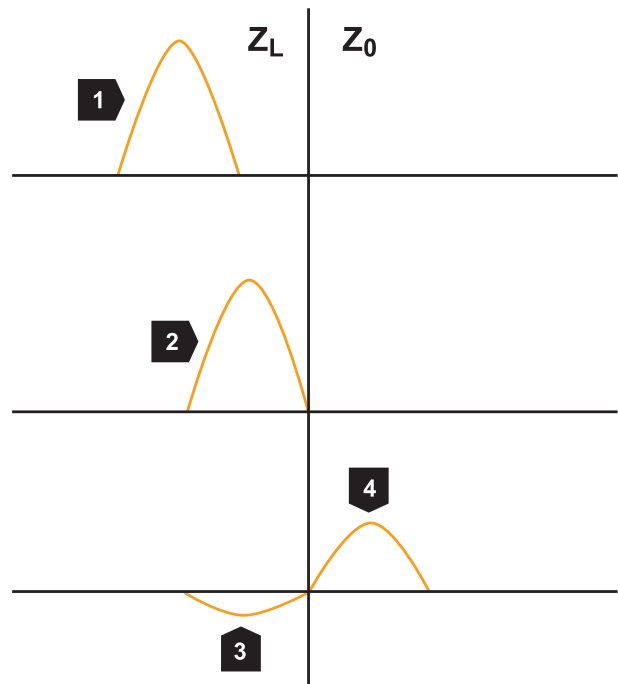

<b>1</b>	Incoming wave
<b>2</b>	Wave hits change in impedance
<b>3</b>	Wave is partially reflected and returns
<b>4</b>	Attenuated wave
$Z_L$	Impedance of the incoming cable
$Z_0$	Impedance after joint

Return loss

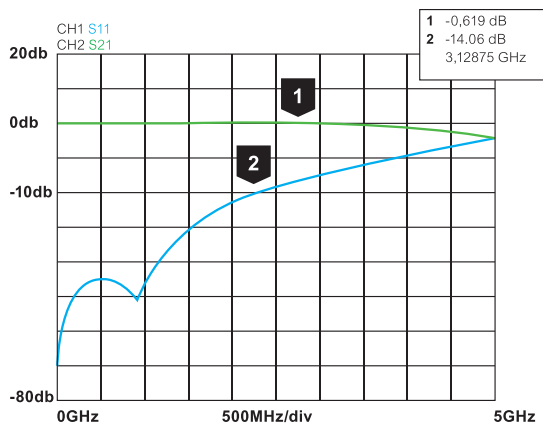

<b>1</b>	Insertion loss
<b>2</b>	Return loss

Diagram: Insertion loss and return loss measured using a network analyser.

In data technology the bandwidth is often described as the “data volume”. Technically, the “data volume” is, however, in fact the data rate. The data rate and bandwidth are often different from one another.

**Cut-off frequency  $f_g$**

The cut-off frequency  $f_g$  describes the frequency-dependent behaviour of the arrestors. Capacitive and/or inductive component properties ensure signal damping at higher frequencies. The critical point is described as the cut-off frequency  $f_g$ . From this point onwards, the signal has lost 50% (3 dB) of its input power. The cut-off frequency is determined according to certain measuring criteria. In the absence of any values, the cut-off frequency generally relates to so-called 50  $\Omega$  systems.

**VSWR**

The (VSWR) Voltage Standing Wave Ratio is the ratio between an outgoing and reflected wave. Standing waves can occur if, for example, there is no terminating impedance on the cable, or if two cables of different impedances are connected together, for example a 50 Ohm coaxial cable with a 75 Ohm coaxial cable.

If there is a mismatch, e.g. in case of an open or short-circuited end of a cable, this can result in the doubling or cancellation of the signal wave.

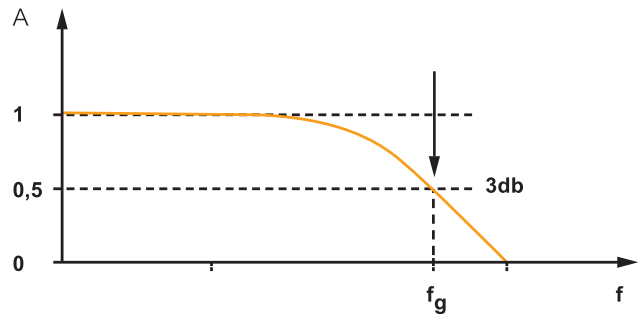

<b>A</b>	Signal amplitude
<b>f</b>	Frequency
<b><math>f_g</math></b>	Cut-off frequency at 3 db

Cut-off frequency  $f_g$

**Bandwidth**

The bandwidth (B) describes the difference in magnitude between the two frequencies at either end of a frequency band. The bandwidth is generally defined as the width of the frequency band where power damping is less than 3 dB.

**NEXT**

Due to capacitive or inductive coupling, signal components from a pair of wires can be coupled onto another pair and cause interference there. This effect is known as Near End Cross Talk (NEXT). Transmission standards, such as the network classes according to EIA/TIA 568A/B or EN 50173-1, specify the maximum NEXT values for a transmission path. The curves below show the transmission characteristics of high-quality and inferior cables.

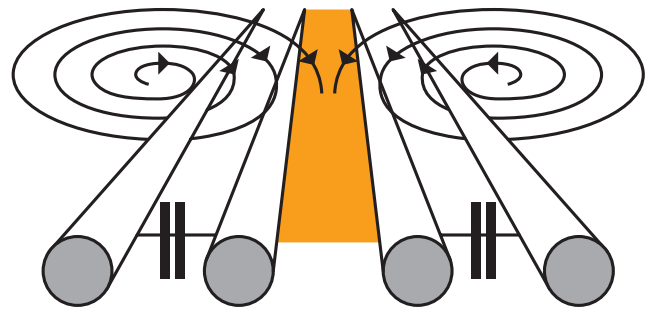

Crosstalk in pairs of wires

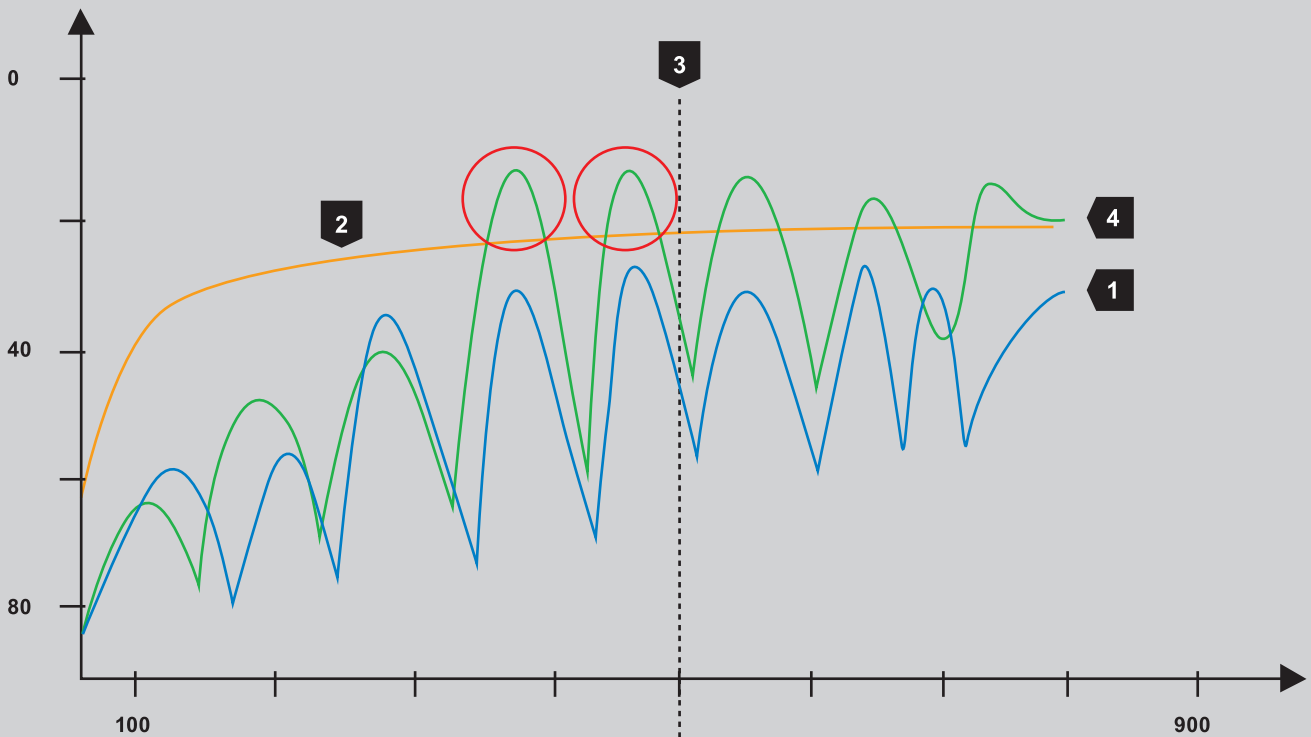

<b>1</b>	Good NEXT values
<b>2</b>	Limit values
<b>3</b>	Relevant frequency range
<b>4</b>	Poor NEXT values

Schematic diagram of a NEXT measurement: comparison of good and poor NEXT values



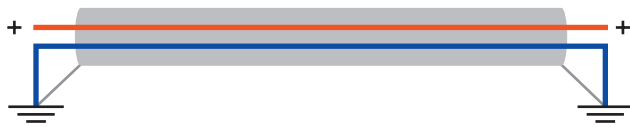

Asymmetrical cable



1	Cable jacketing
2	Insulation of wire A
3	Insulation of wire B
4	Conductors of wires A/B

Symmetrical cable

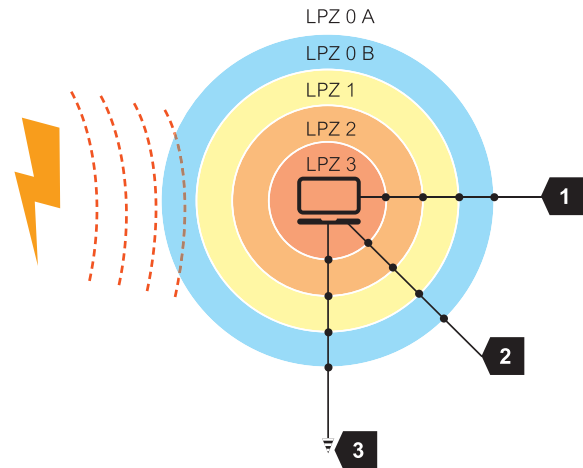

1	Energy cable
2	Data cable
3	Equipotential bonding system

Cables passing through all lightning protection zones

**3.3.1.6 Symmetrical and asymmetrical data transfer**

Asymmetrical interfaces consist of a data conductor and an earth wire. In this case the signal voltage changes in relation to a reference potential/earth.

In symmetrical data transmission, instead of one data cable, two data cables are used to carry a signal, for example in the case of Twisted Pair cables. The two wires are 180° out of phase. If a fault is coupled onto a signal-carrying wire, it will couple onto the second wire as well. Due to the phase difference, the interference signal is virtually cancelled out. The terms (a)symmetrical and (a)synchronous are also used in relation to transmission systems such as DSL. These terms refer to the symmetry or synchronicity of the data rate. During downlink/download, the data rate generally differs considerably from that during up-link/upload. For example, with ADSL, data can be downloaded faster than they can be uploaded. In SDSL the two data rates are the same.

**3.3.1.7 Device protection classes**

Objects at risk from lightning and surge voltage are classified into lightning protection zones (LPZs). The aim of these LPZs is to reduce the amplitude of the lightning current/surge voltage in individual zones to at least value of the voltage resistance of the devices in that zone. Supply lines such as energy and data cables often run through all of the zones.

A suitable surge protection device must be chosen for each zone. The protection class is marked on many OBO surge protection devices.



1	Unprotected side
2	Protection class, basic protection
3	Protected side/device

LPZ 0 B - 2, final code B = basic protection, red colour coding

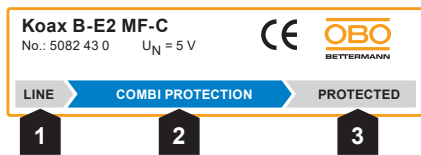

1	Unprotected side
2	Protection class, combi protection
3	Protected side/device

LPZ 0 B - 3, final code C = combi-protection, blue colour coding



1	Unprotected side
2	Protection class, fine protection
3	Protected side/device

LPZ 1 - 3, final code: F = fine protection, green colour coding

### Basic protection

Basic protection devices are lightning arrestors of class 1 that can directly arrest lightning currents and surge voltages. The single-stage protection circuit contains gas arrestors. These devices are installed where the lines enter the buildings. They serve to arrest lightning current with the waveform 10/350  $\mu$ s coupled from outside the building via the data cables.

### Combined protection

The combined protection devices limit the transients with gas-discharge protectors or transzorb diodes, which are decoupled through resistors. These correspond to classes 1, 2 and 3 or categories D1 and C2 as defined in the standard DIN EN 61643-21. The devices can be installed as basic protection where the cables enter the building, or as fine protection directly before the terminal. In the latter case, it should be noted that the distance to the device needing protection should not exceed 10 metres. If it does, then a further fine protection device should be installed before the device.

### Fine protection

The fine protection devices use transzorb diodes to limit surge impulses. The devices are earthed with powerful gas discharge protectors. The decoupling of basic and fine protection is achieved when the line section between basic and fine protection device is at least five metres. Fine protection devices should always be installed on the device to be protected itself.

**Versions**

To ensure the correct functioning of data cable protection devices, various aspects must be considered when installing them. The following chapters are dedicated to discussing these aspects.

**Choosing the right surge protection device**

Later in this guide, you can find an extensive selection aid that will help you greatly in choosing the right surge protection device for a given application. If the required interface is not listed, check the following technical properties of your signal interface and compare it with the characteristics of the surge protection device:

Type of system (telecommunications application, MCR, etc.)

Polarity/number of wire connections required

Maximum permissible continuous voltage of surge protection device

Maximum permissible load current of surge protection device

Frequency range supported

Installation location and mounting options (DIN rail, adapter connector, etc.)

Protection class required (basic protection, fine protection, combination protection)

An unsuitable surge protection device can considerably impair the application itself, for example by causing excessive attenuation of the signal circuit. If the voltage or the load current of the system exceeds the characteristics of the surge protection device, the surge protection device can be destroyed due to overloading.

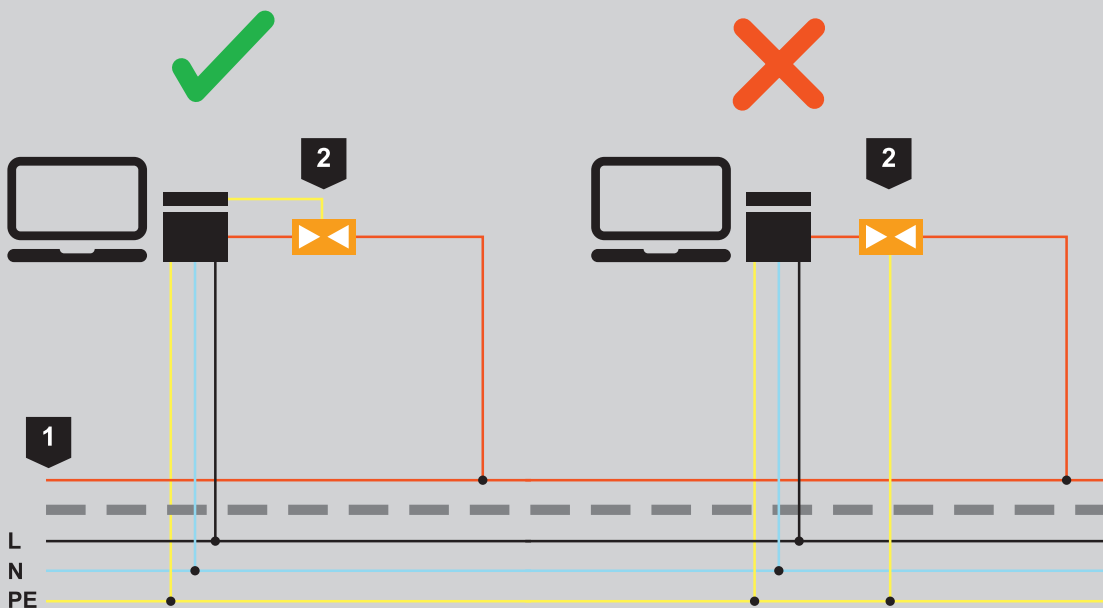

<b>1</b>	Signal line
<b>2</b>	Protection device
<b>L</b>	Phase
<b>N</b>	Neutral conductor
<b>PE</b>	Protective conductor

Installation example showing correct and incorrect potential connection on protection device

### 3.3.2 Installation of data cable protection devices

If the cables are too long, a voltage drop will occur due to the high inductance, which will have a negative impact on the protection level of the surge protection device. The voltage protection level can increase so dramatically that the voltage resistance of the terminal device is exceeded and the device is damaged despite the presence of surge protection.

#### 3.3.2.1 Equipotential bonding of data cables

Unlike in energy technology, in data technology longitudinal and transverse voltages occur which must be minimised using suitable arrestors with voltage-limiting components. To achieve low voltage protection levels, these surge protective devices must be incorporated as directly as possible into the equipotential bonding system. Long cable lengths should be avoided. The best solution is the local equipotential bonding. Shields are also extremely important. Complete shield action against capacitive and inductive coupling can only be effective when the shield is included with low impedance on both sides in the equipotential bonding.

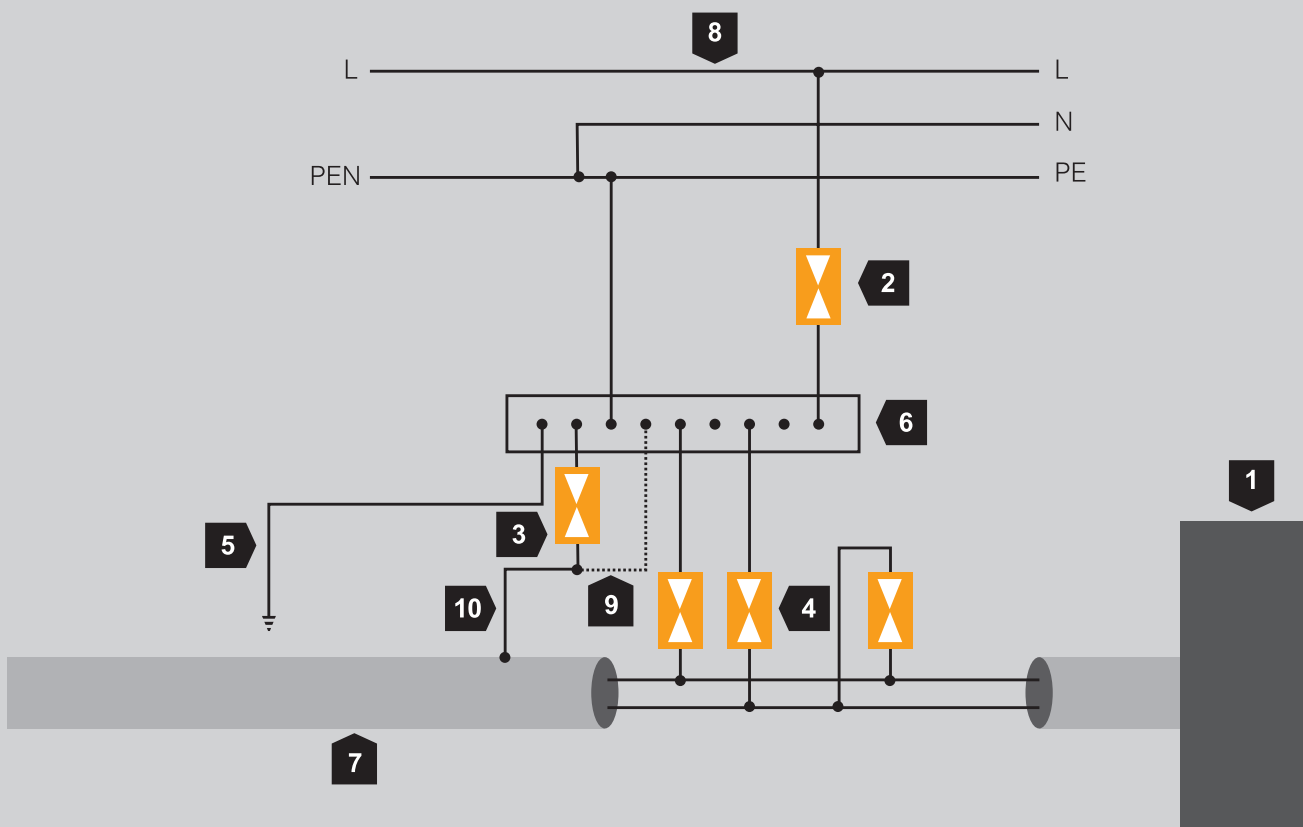

<b>1</b>	Device to be protected/telecom line
<b>2</b>	Surge protective device (energy technology)
<b>3</b>	Gas discharge arrestor (indirect shielding)
<b>4</b>	Gas discharge arrestor
<b>5</b>	Connection to equipotential bonding
<b>6</b>	Equipotential busbar

<b>7</b>	Telecommunications line
<b>8</b>	Electric cable
<b>9</b>	Direct connection to equipotential bonding (preferred)
<b>10</b>	Conductive shield of the data cable
<b>L</b>	Phase
<b>N</b>	Neutral conductor
<b>PE</b>	Protective conductor

Equipotential bonding of data cables

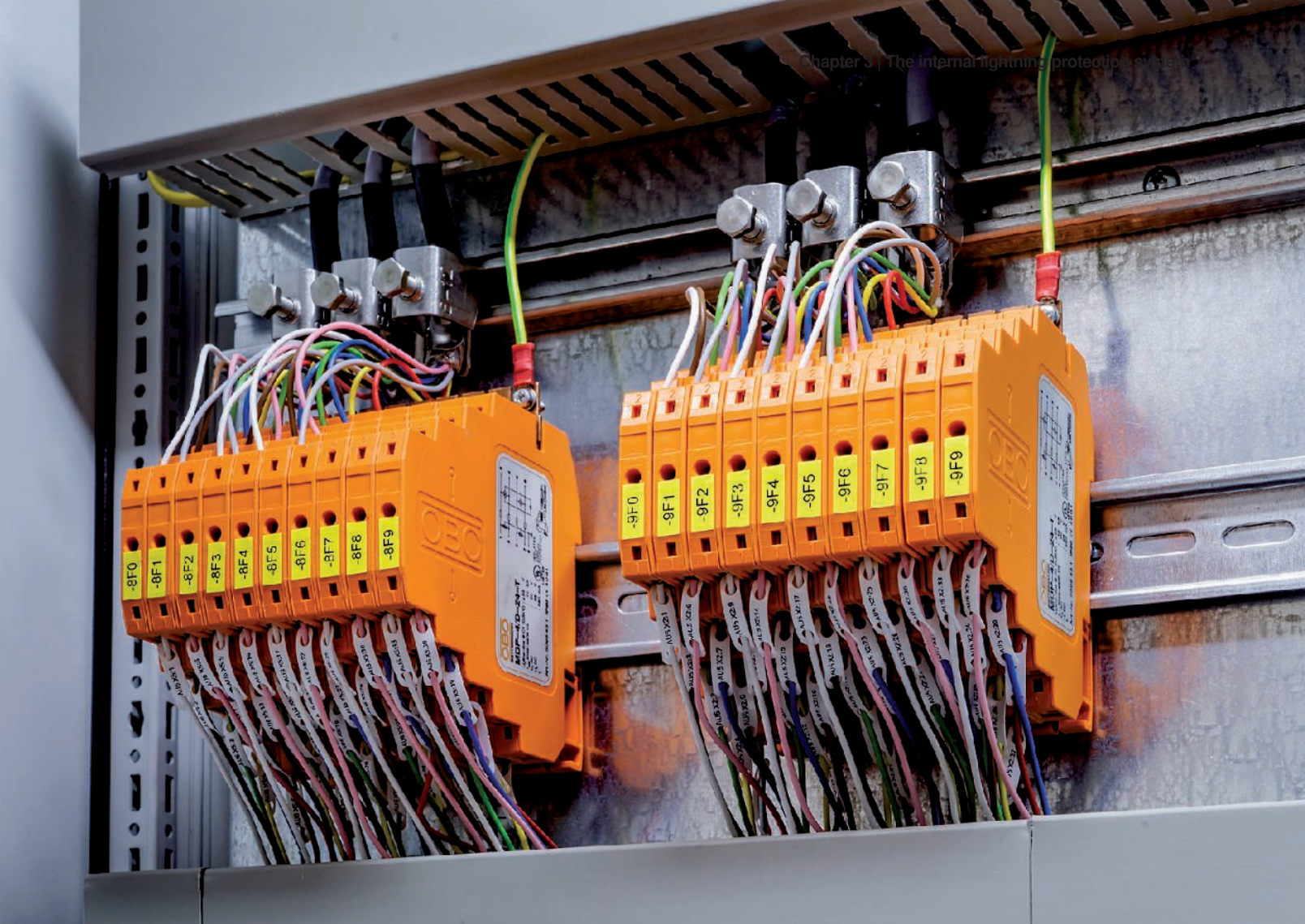

MDP lightning barriers in an switching cabinet

### 3.3.2.2 Measurement and control technology

Measurement and control technology and fieldbus systems allow automated control of production lines or remote monitoring of many different types of sensors and actuators. Today, this technology forms the core of any modern industrial company. Their failure would result in high financial losses. To prevent this, the systems must be protected against surge voltages from inductive and capacitive couplings.

Lightning barriers TKS-B, FRD, FLD, FRD 2 and FLD 2 protect electronic measuring, controlling and regulating systems from surges. In areas where a particularly narrow installation width but large number of terminals is needed, type MDP lightning barriers are used.

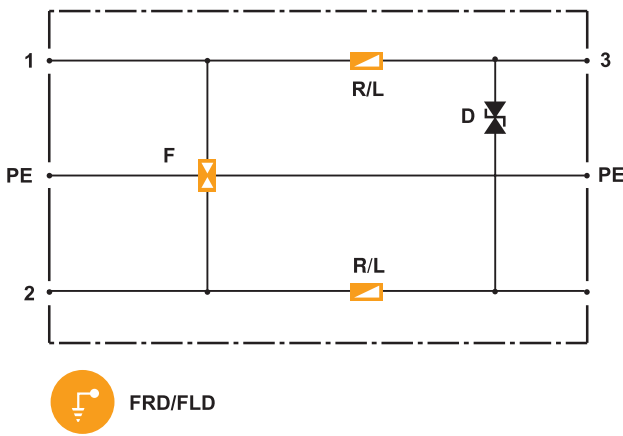

Circuit diagram of lightning barrier FRD/FLD

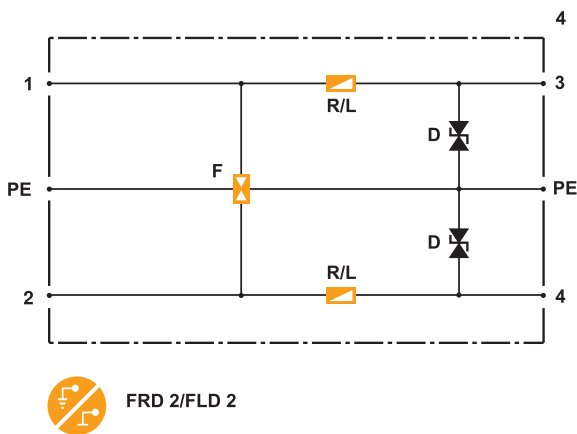

Circuit diagram of lightning barrier FRD2/FLD2

### Type series FRD/FLD

Type FRD, FLD and MDP lightning barriers are designed for use in so-called floating (asymmetrical, potential-free) two-core systems. These are systems whose signal circuits have no common reference potential with other signal circuits, e.g. 20 mA current loops. These devices can be universally applied.

### Type series FRD2/FLD2

Type FRD2 and FLD2 are intended for use in ground-referenced (symmetrical, potential-referenced) single-wire systems.

Ground-referenced systems are signal circuits that have a common reference potential with other signal circuits. In these systems, two further data cables besides earth are protected. The decision to use FRD (with resistive decoupling) or FLD (with inductive decoupling) depends on the system to be protected.

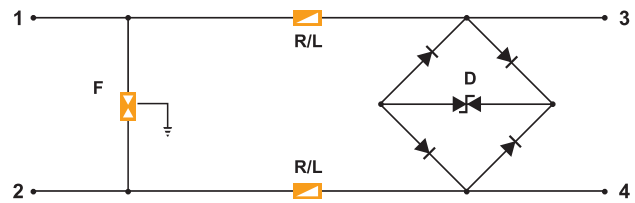

Basic protection circuit in measuring circuit

### Use of lightning barriers in measuring circuits

Before lightning barriers are used in measuring circuits, it must first be confirmed whether a resistance increase is permitted. Depending on the decoupling, resistance increases in the measuring circuits can occur with types FRD and FRD2. This can result in errors with current loop measurements. FLD/FLD2 and/or MDP devices should therefore be used in this case. The maximum operating current should also be verified to ensure that the dissipated energy does not cause thermal destruction of the decoupling elements.

In the case of arrestors with integrated inductances for decoupling, the signal is attenuated at high transfer frequencies. Therefore, when used in measuring circuits with high transfer frequencies, lightning barriers with resistive decoupling elements are the preferred solution.

**Surge protection for potentially explosive areas**

Surge protection is an important topic in potentially explosive areas. It is important here to protect costly measuring technology against the influence of surge voltages through atmospheric discharges. Sensitive measuring technology, whose cables are often routed outdoors, are particularly at risk from surge voltages and lightning strikes. A typical set-up is shown below for a 0–20 mA interface with the intrinsically-safe OBO products MDP and FDB.



Sensor with Petrol Field Protector FDB

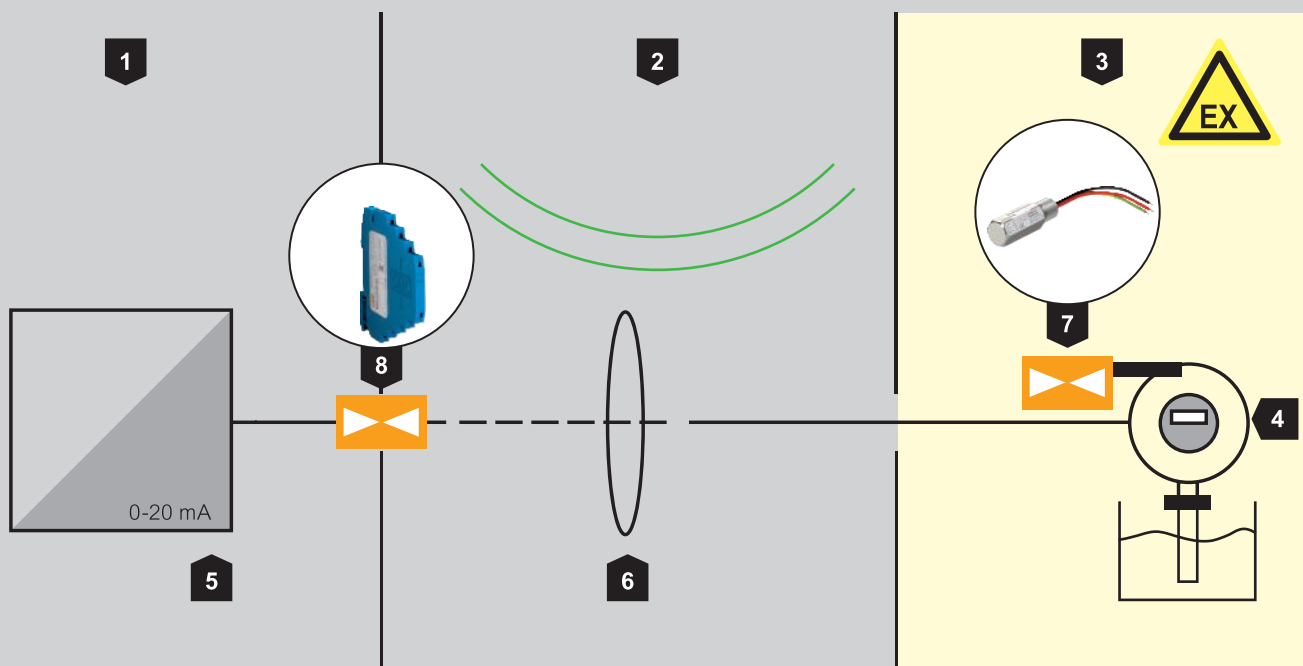

1	Protected side
2	Field
3	Ex area zone 1, 2
4	Protected sensor
5	Signal source
6	Coupling
7	Surge protection device on field device (e.g. FDB)
8	Ex separation barrier in front of the signal source (e.g. MDP)

Application example – protection of a measurement/control signal line in an ex area

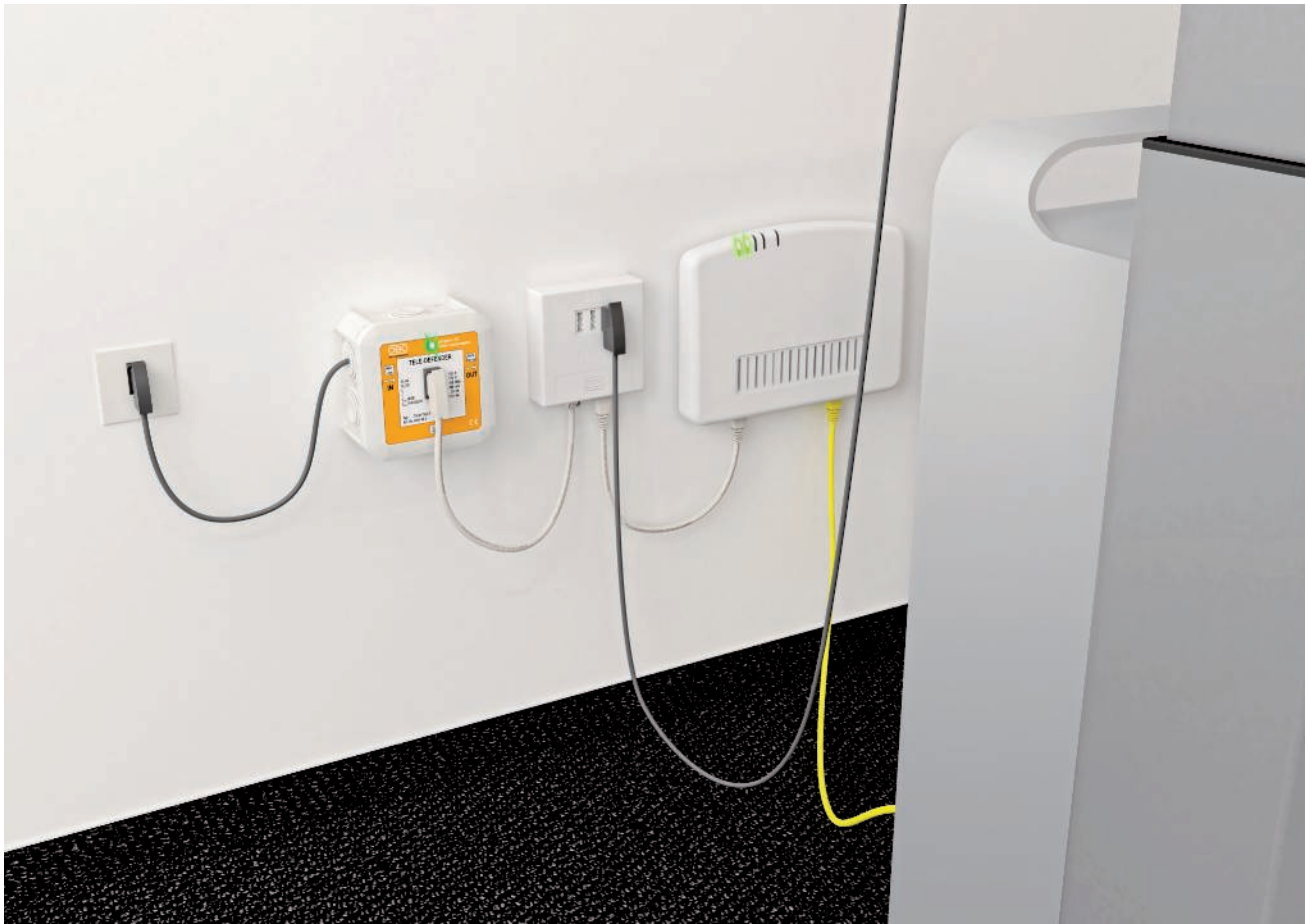

Protection of an ISDN + DSL connection with TeleDefender

### 3.3.2.3 Telecommunications

Today, telecommunications are used in all kinds of different applications. Many people associate the term “telecommunications” only with the traditional telephone, but the spectrum is much broader. Telecommunication means the transmission, over a substantial distance, of any kind of information via technical infrastructures. That includes everything from high-speed transmissions via optical fibre to sending a simple fax.

#### Telephone systems

In many cases, modern telephone systems also act as interfaces for a number of different data services, e.g. the Internet. Many terminal devices that enable this access are connected into the lines themselves and must be integrated into the surge protection concept accordingly. As there are now a number of different systems, these devices must have selective protection. There are three distinctly different essential systems.

#### Standard analogue connection

Unlike other systems, the standard analogue connection offers no additional services. Access to the Internet is via a separate modem. Because the analogue connection without technical accessories provides only one channel, the Internet cannot be accessed while telephoning and likewise, no telephone call is possible while surfing.

#### ISDN

(Integrated Services Digital Network System)

In contrast to the analogue connection, ISDN allows two conversations to take place at the same time via a special bus system (S0 bus), which provides two channels. This enables the user to surf on the Internet while telephoning and at higher data rates than is possible with the analogue connection (64 kBit/s over one channel). ISDN also offers other services such as call waiting, callback, etc.



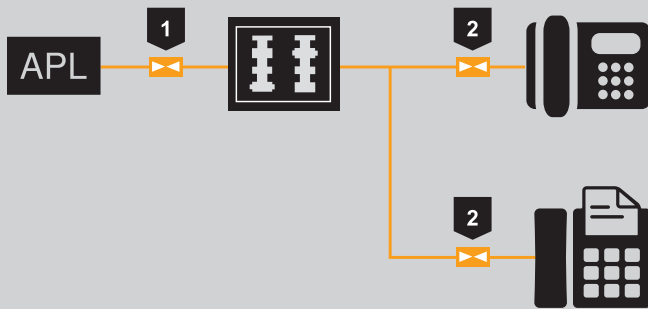

	Device	Item no.
1	TKS-B or TD-4/I	5097976 5081690
2	RJ11-TELE 4-F	5081977

*Protection of an analogue telephone connection*

### Analogue connection

Analogue telephone system

- One line (without system connection)
- Low data throughput (56 Kbit/s)

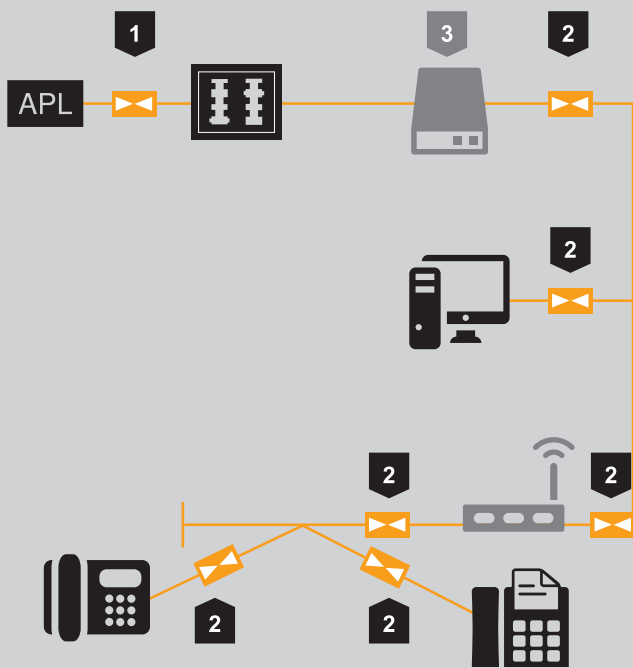

	Device	Item no.
1	TKS-B or TD-4/I	5097976 5081690
2	ND-CAT6A/EA	5081800
3	NTBA	-

Protection of an ISDN connection

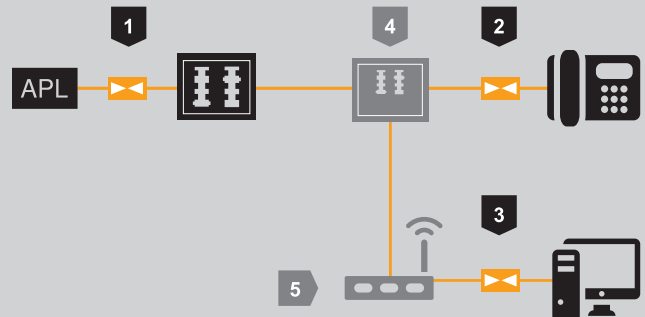

	Device	Item no.
1	TKS-B or TD-2D-V	5097976 5081698
2	RJ11-TELE 4-F	5081977
3	ND-CAT6A/EA	5081800
4	Splitter	-
5	DSL modem	-

Protection of a DSL+ analogue telephone connection

### DSL system (Digital Subscriber Line)

The currently most widely used system is probably DSL. Speech and data channels are separated by splitters. The data channel is routed to a special modem (NTBBA), which is connected to the PC via a network card. DSL data rates are higher than those of analogue and ISDN systems and therefore enable fast downloading of music and films from the Internet.

Because there are a number of different DSL versions such as ADSL and SDSL, the general DSL is also designated XDSL. XDSL permits the use of analogue telephones without additional hardware, as well as a combination with ISDN. The following circuit diagram shows how it is possible to protect a typical ISDN/analogue + DSL connection. You can find a comprehensive overview in the selection aids starting on page 255.

DSL connection in combination with an ISDN connection

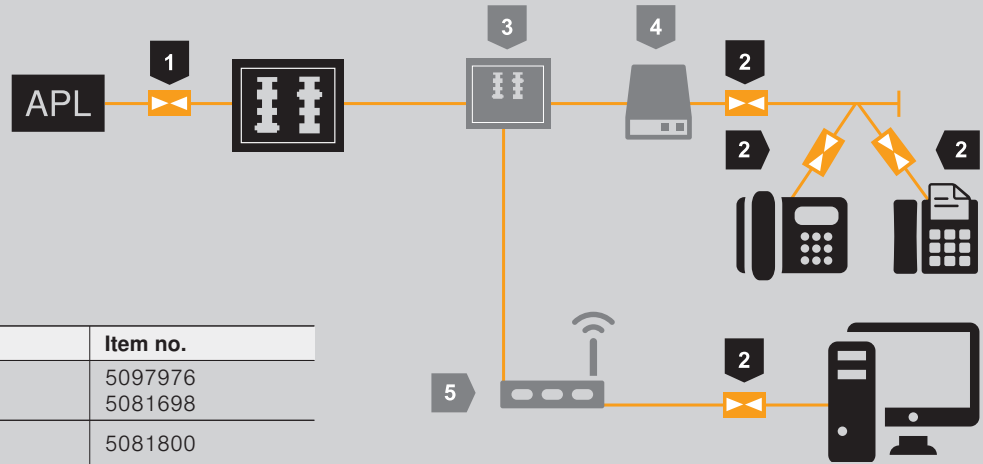

	Device	Item no.
1	TKS-B or TD-2D-V	5097976 5081698
2	ND-CAT6A/EA	5081800
3	NTBA	-
4	Splitter	-
5	DSL modem	-

Protection of an ISDN + DSL connection with TeleDefender

IP connection

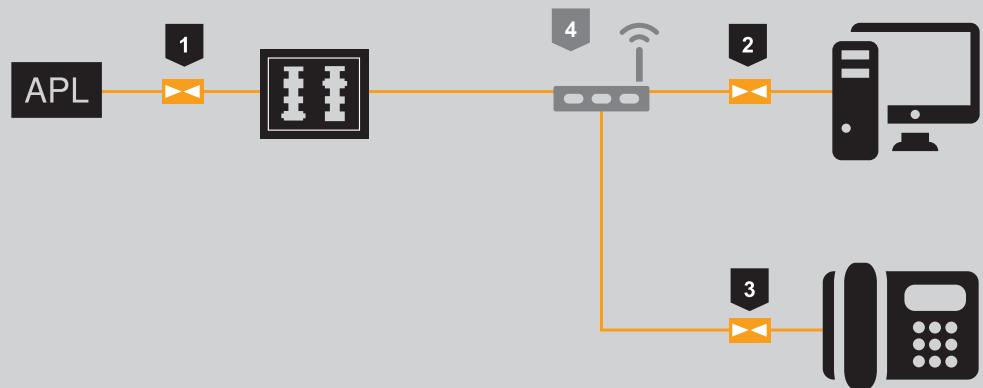

	Device	Item no.
1	TD-2D-V	5081698
2	ND-CAT6A/EA	5081800
3	ND-CAT6A/EA (IP/ISDN telephone)	5081800
3	RJ11-Tele 4-F (analogue telephone)	5081977
4	IP modem	-

Protection of an IP connection

### 3.3.2.4 High-frequency technology

High-frequency technology is often used in systems for the wireless transmission of information such as voice, data or video. This section introduces several of the best-known technologies:

#### GSM

GSM stands for Global System for Mobile Communications and is a global standard for all-digital mobile communications. It is used primarily for pure telephony between mobile telephone subscribers. However, it also offers the possibility of circuit-switched and packet data transport. GSM was introduced in Germany in 1992.

#### UMTS/LTE

The Universal Mobile Telecommunications System (UMTS) allows a much higher data rate than GSM. This third-generation standard permits a transmission speed of 42 Mbit/s with HSDPA+ or up to 300 Mbit/s with the fourth-generation standard, LTE (Long Term Evolution). LTE is also used for supplying broadband data services to rural regions to eliminate blank spots, i.e. areas with less than 1 Mbit/s data connection.

#### TETRA/BOS

TETRA is a standard for digital trunked radio and stands for “terrestrial trunked radio”. It can be used for classic voice transmission but also for data, signalling and positioning services. It is therefore very versatile. The service is also used by authorities and organisations performing safety and security tasks (BOS).

#### GPS

GPS, or Global Positioning System, is a satellite system for determining location. Possibly the best-known application of this technology is navigation systems.

#### SAT-TV

Like GPS, SAT-TV uses a satellite system for transmission and is used for transferring analogue and digital TV programmes. To receive the signals a satellite dish and an LNB (Low Noise Block) are needed; the LNB converts the frequencies from satellite transmission into frequencies that can be used in coaxial cables.



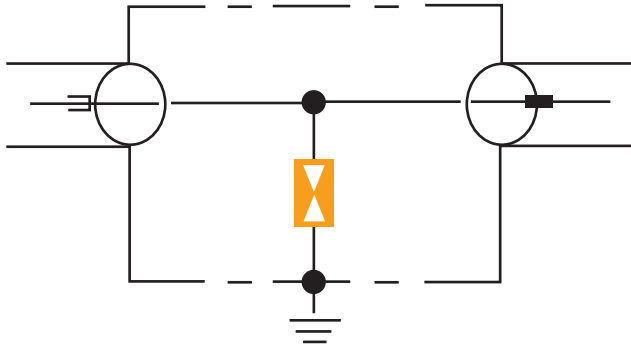

Coaxial surge protective device with gas-discharge protector

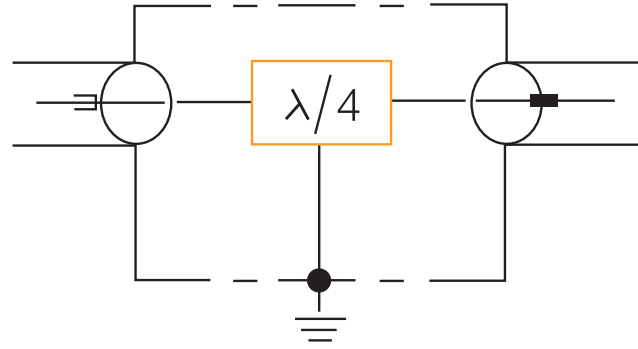

Coaxial surge protective device with Lambda/4 technology

These sensitive, high-frequency systems need to be protected from lightning currents and surge voltages. Suitable arrestors for these applications include the DS coaxial surge arrestor from OBO Bettermann. These offer optimal transmission behaviour with low damping values and are connected in series to the transmission path. They are available for all standard connections. Coaxial arrestors come in two types: With either a gas-discharge protector and Lambda/4 technology.

#### Coaxial surge protective devices with gas-discharge protector

The first type is coaxial surge protective devices with a gas-discharge tube. These enable transmission from a frequency of 0 Hz (DC). They are available for virtually all plug systems. They can therefore be used in a wide range of applications. The gas-discharge tube can additionally be replaced in case of defect. Due to the capacity of the gas-discharge tube they are however limited in their bandwidth: the cut-off frequency is currently around 3 GHz. For example, no Wi-Fi signals according to the 802.11n standard with a frequency of up to 5.9 GHz can be transmitted.

#### Surge arrestors with Lambda/4 technology

The second variant is the surge arrestor with Lambda/4 technology. These arrestors are band-pass filters that only pass frequencies within a specific range. For signals outside the frequency range supported, this arrestor type is a galvanic short circuit. The advantages of this technology are its support for frequencies of up to around 6 GHz, and its very low protection level of approximately 30 V. They also require virtually no servicing because they do not use a gas-discharge protector.

The disadvantages of these devices are that it is not possible to transmit DC supply voltage along the signal line, and their scope of application is generally limited to just one application, depending on whether the necessary frequencies lie within the frequency range supported.

**Standards governing the lightning protection of antenna systems**

The rules for the connection of an antenna to a lightning protection system are contained in various standards:

- IEC/EN 60728-11  
According to VDE 0855-1, the antenna system does not replace the lightning protection system. It is accepted that partial lightning currents can occur due to direct strike and inductive coupling. This standard describes the minimum requirements for non-isolated lightning protection.

- IEC/EN 62305-3  
The antenna mast on the roof of a building should only be connected with the air-termination system if the antenna system is not within the protected area of the air-termination system. Surge voltage protection devices should be installed in order to limit surge voltages.

The figure below shows how an antenna system can be protected against lightning:

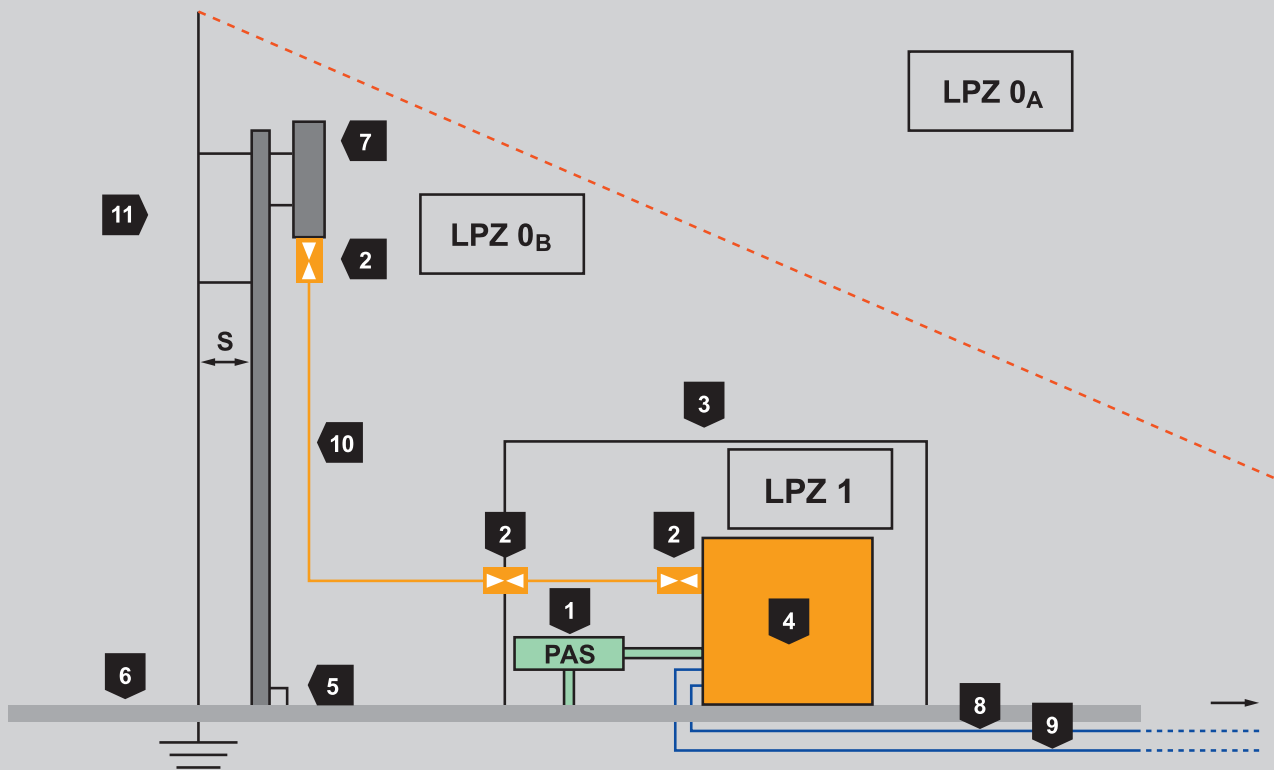

1	Equipotential busbar (energy and data technology)
2	Coaxial surge protective devices (variable)
3	Shielded building
4	Transmitter/receiver
5	Connection lug
6	Foundation earther
7	Antenna
8	Energy cable
9	Data cable
10	Coaxial cable
11	Air-termination system with separation distance (s)

Protection of an antenna system

The insulated structure means that no partial lightning current is able to flow through the antenna cable. The precondition is that the separation distance (s) is maintained. The power and data cables must be integrated into the lightning protection equipotential bonding at the entry to the building. In case of a direct strike on the insulated air-termination system, partial lightning currents can occur in the cable due to the increase in potential at earth and presence of different earthing systems. Careful use should therefore be made of lightning arrestors in this area. In order to avoid arcing from the shield of the cable onto the signal line, the lightning arrester equalises the potentials of the shield and the signal line.

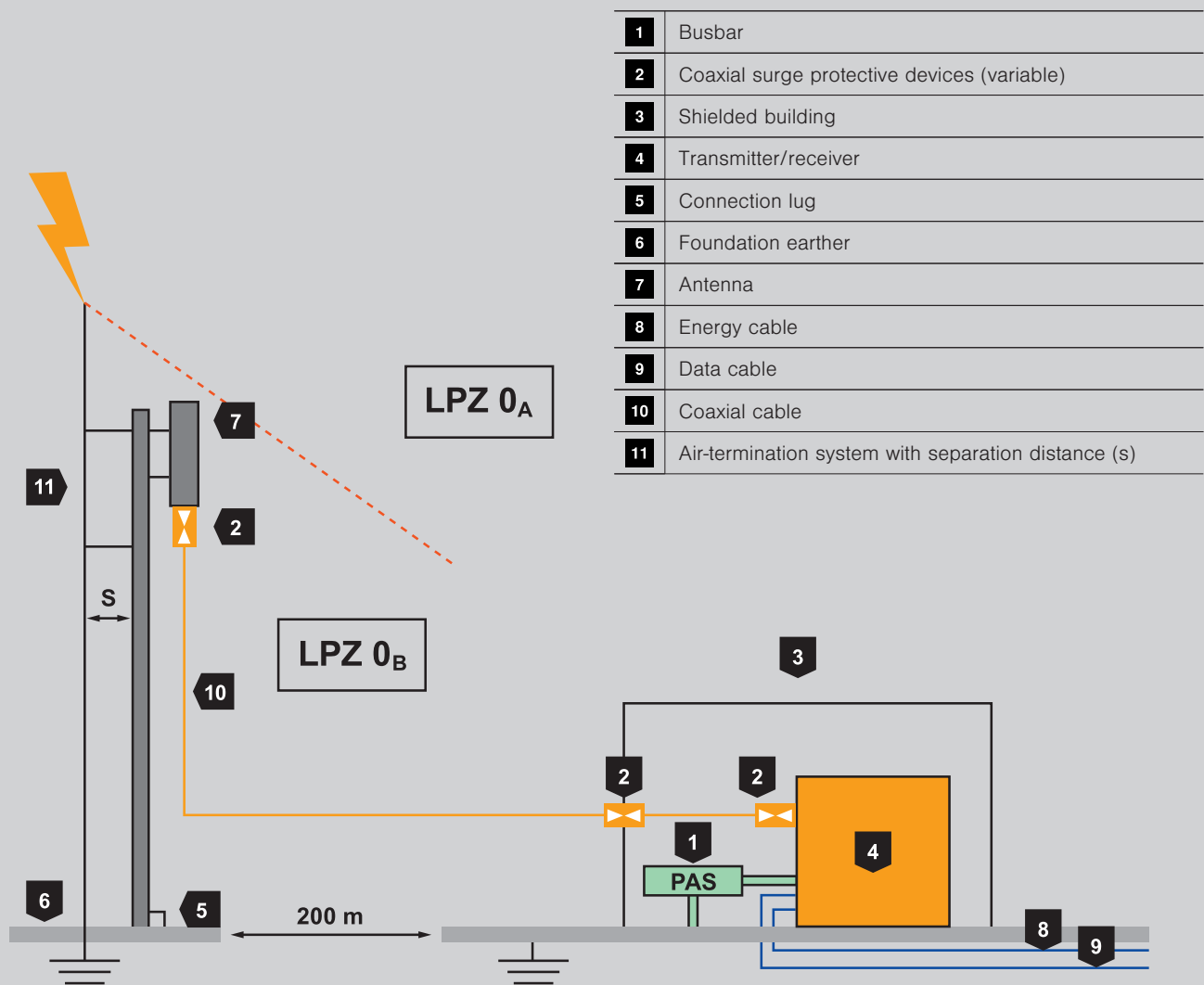

Insulated lightning protection on an antenna system and various earthing systems

**Satellite systems according to IEC/EN 60728-11**

Satellite systems and antennas are often in exposed locations on roofs, next to the air-termination rods. For this reason, air-termination rods must be used to protect these systems against direct lightning strikes, to prevent them from serving as lightning air-termination systems themselves. Ideally, in the finished lightning protection system the satellite antenna should be located within the protective angle of the air-termination rod. In this case, the risk of a direct lightning strike in the SAT cables is almost zero.

However, if the air-termination rod is struck, surge voltages will be coupled. Using, for example, a surge protection device like the OBO TV 4+1 (for protecting, for example, multiswitches) or FC-SAT-D (for protecting a TV set), these surge voltages can be limited to a level that is safe for the device in question. Here, it is vital that the required separation distance ( $s$ ) is maintained between the air-termination rod and the antenna system. The following figures show the lightning and surge protection for a satellite TV system:

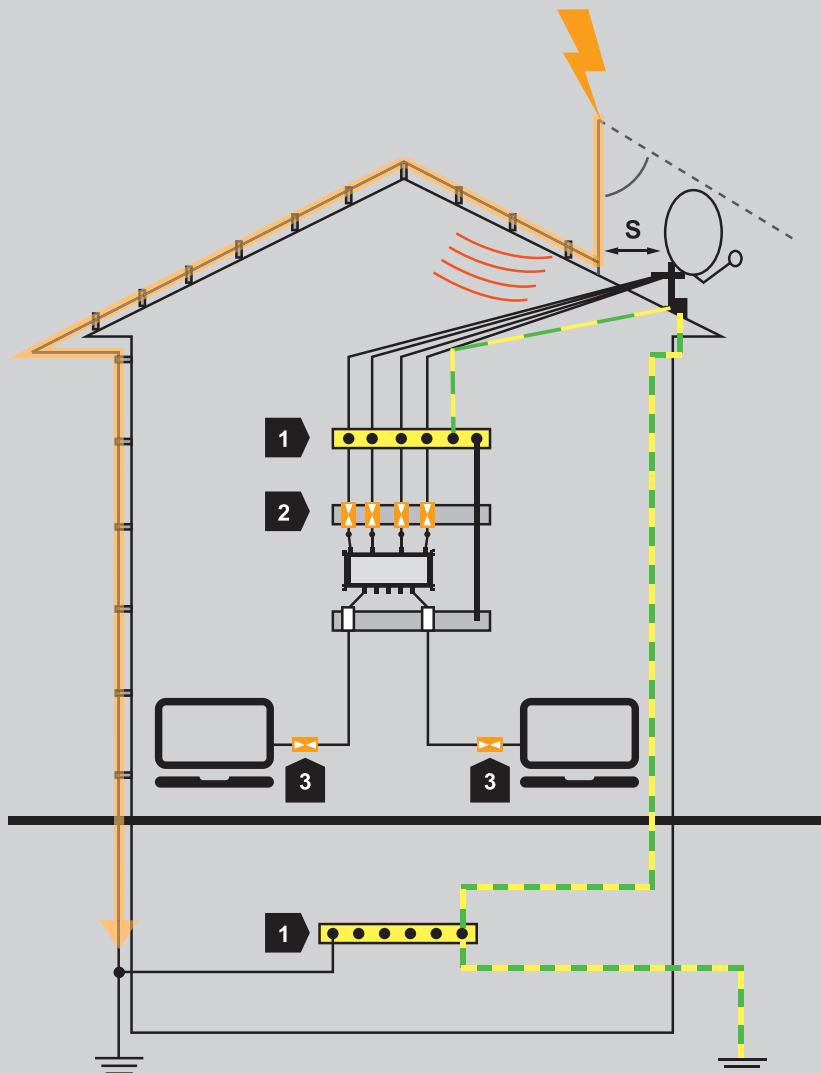

	Device	Item no.
1	Equipotential busbar, e.g. 1801 VDE	5015650
2	Coaxial surge protection, e.g. TV 4+1	5083400
3	Fine protection device for SAT and 230 V supply line, e.g. OBO FC-SAT-D	5092816

Current path in case of a direct strike close to a satellite dish



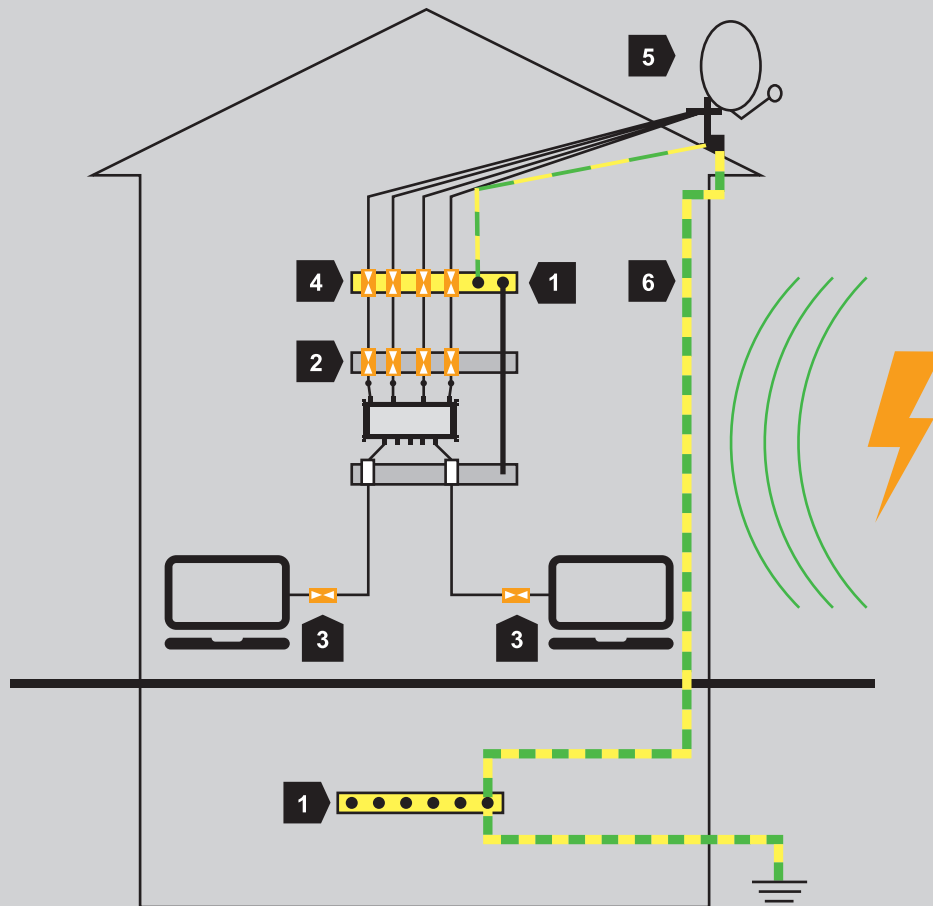

	Device	Item no.
1	Equipotential busbar, e.g. 1801 VDE	5015650
2	Coaxial surge protection, e.g. TV 4+1	5083400
3	Fine protection device for SAT and 230 V supply line, e.g. OBO FC-SAT-D	5092816
4	OBO DS-F lightning arrester	5093275/5093272
5	Antenna earthing with 4 mm <sup>2</sup> Cu	-
6	Min. 16 mm <sup>2</sup> Cu earthing conductor	-

#### Induction of surge voltage into a satellite TV system

With appropriate coordination of the lightning and surge protection components, lightning currents and surges can be safely arrested. If there is no external lightning protection on the building, the exposed satellite system is at risk of attracting a direct strike, like an air-termination rod.

For this reason, class D1 lightning arrestors are needed in addition to the surge protection. As well as the standard antenna earthing using 4 mm<sup>2</sup> Cu, the antenna system must additionally be connected with the main earthing rail using a copper earthing conductor of minimum 16 mm<sup>2</sup>.

Should a risk analysis according to IEC/EN 62305-2 not be possible or not be required by the authorities, then static atmospheric surge voltages (e.g. lightning) can cause arcing from the 16 mm<sup>2</sup> earthing conductor to the electrical installation or the antenna system of the building. For this reason, we recommend making the earthing conductor insulated and resistant to high voltages and floating discharges through suitable measures.

### 3.3.2.5 Data technology

Data technology is used in a wide range of applications. It extends from the simple installation of a printer connected to a PC to complex networks with several thousand clients. In all cases, careful planning of surge protection measures is required, taking account of the data interfaces at hand.

#### Ethernet

Ethernet is the standard technology for networked computer systems today. Specified data transmission rates range from 10 Mbit/s to as much as 10 Gbit/s today, and the data can be transmitted over both classic copper cables and fibre optic cables. The standard includes cable and connector types such as RJ45.

#### Interfaces

External devices such as printers, scanners and control systems activated via serial or parallel interfaces must be additionally integrated into the surge protection concept.

There is a range of interfaces for different applications: from bus lines for telecommunication and data transfer through to simple terminal devices such as printers or scanners. OBO also offers a host of protective devices that are simple to install, depending on the particular application.

#### • RS232 interface

The RS232 is a frequently used interface. It is used, for example, for modems and other peripherals. Although now largely replaced by the USB interface, the RS232 standard is still frequently used for control lines.

#### • RS422 interface

The RS422 is a serial high-speed standard suitable for communication between a maximum of ten users, which is designed as a bus. The system can be designed for a maximum of eight data lines, although two are always used as send and receive lines.

#### • RS485 interface

The RS485 industrial bus interface differs slightly from the RS422 in that the RS485 enables the connection of several transmitters and receivers (up to 32 users) via a protocol. The maximum length of this bus system, when twisted-pair cables are used, is approx. 1.2 km with a data rate of 1 Mbit/s (dependent upon serial controllers).

#### • TTY system

Unlike the RS232 or other serial interfaces, the TTY system is not voltage-controlled – instead it delivers an imposed current (4–20 mA). This enables cable lengths of several hundred metres to be realised.

#### • V11 interface

V11 is the German designation for the RS422. The American nomenclature, however, is the most widely used.

#### • V24 interface

V24 is the German designation for RS232. The American nomenclature, however, is the most widely used.

### Structured cabling

The standard for structured cabling defines how to cable a building in a universal way. “Universal” in this sense means the emphasis is on generic cabling. This means that the cables are installed not just for one specific service, such as exclusively network connections, but for many different ones (speech, data, audio, telephone, measurement and control, etc.). The advantage of this approach is that a cable can quickly and effortlessly be switched to a different application with no need to install new cables. Structured cabling is covered by the standard CENELEC EN 50173-1.

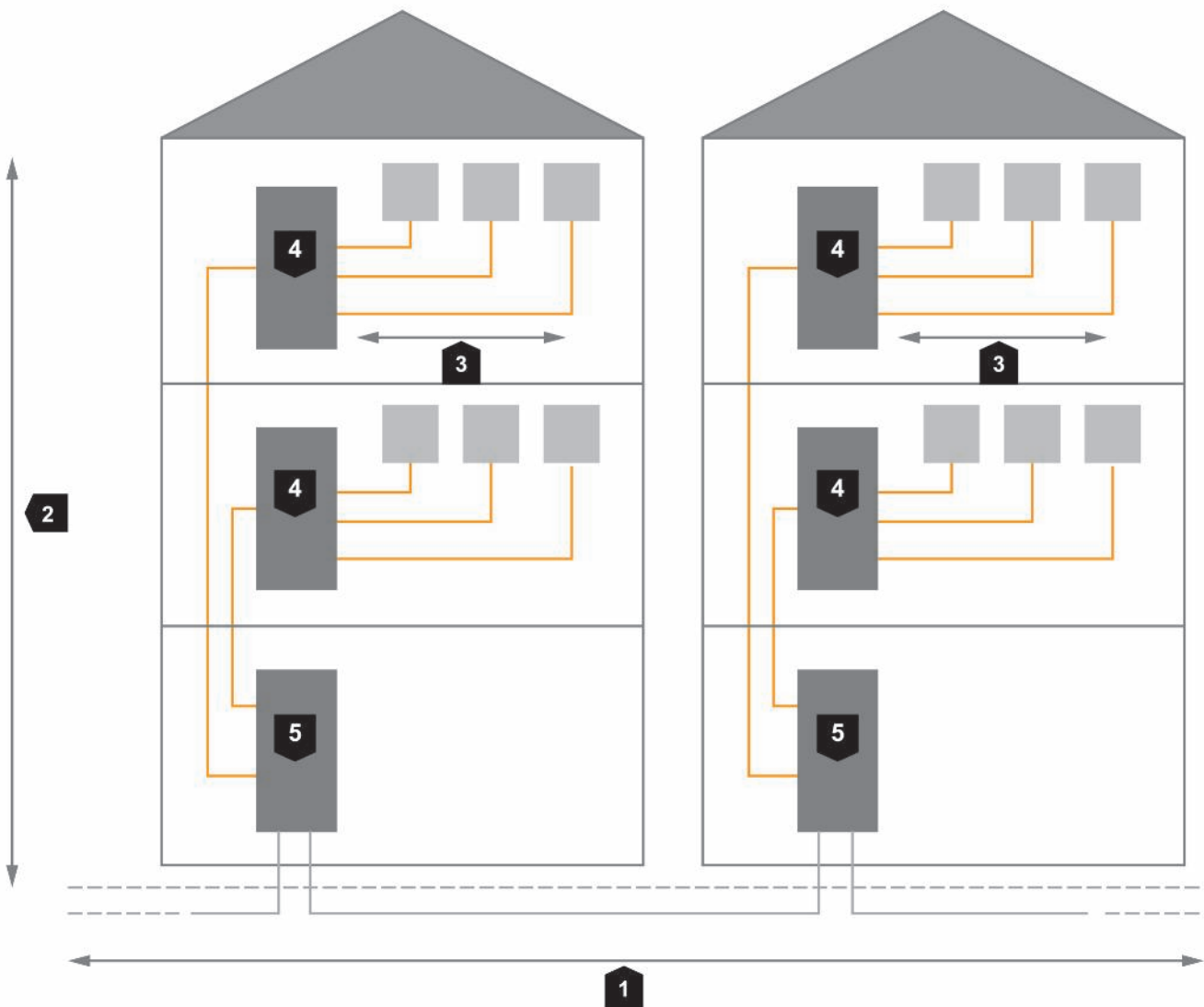

<b>1</b>	Primary cabling
<b>2</b>	Secondary cabling
<b>3</b>	Tertiary cabling
<b>4</b>	FD: floor distributor
<b>5</b>	BD: building distributor

Basic principles of structured cabling

In structured cabling, the cabling is divided into three subsections:

### 1. Primary cabling

The primary cabling is for connecting building complexes (horizontal). The connection point is the building distributor (BD). Primary cabling can be characterised by long cable lengths due to the locations of different buildings. The speed of the connection also plays an important role. For fast transmission rates to be achieved, fibre optic technology is often used as the transmitting medium in the primary cabling. This offers higher data rates than conventional copper cables and is also less susceptible to interference from electromagnetic impulses.

### 2. Secondary cabling

The secondary cabling connects the individual floors of the building with one another (vertical). The floor distributors are directly linked to the building distributor and, at the same time, offer connection opportunities for the various terminal devices/connections sockets. Here, too, fibre optic technology is used as the transfer medium.

### 3. Tertiary cabling

In tertiary cabling, fibre optic cables can be used as the transmission medium as an alternative to copper network cabling. The tertiary cabling is the cabling that links terminal devices/connection sockets with floor distributors within a floor of the building (horizontal). Various transmission media are used here. In fibre-to-the-desk, the floor distributor and terminal device are linked by a fibre optic cable. However, the most widespread option is the classic connection via Twisted Pair cable.

Lightning and surge protection measures should be installed to ensure that this infrastructure remains free from faults and is not destroyed by powerful currents. Where a building is fitted with external lightning protection, lightning currents and surge voltages pose a particularly high risk. If the separation distance (s) is not maintained, there is a risk of arcing from the external conductor system onto internal cables running along the building wall, for example in dado trunking.

*In buildings with an external lightning protection system, internal protection against partial lightning currents and surge voltages is needed.*

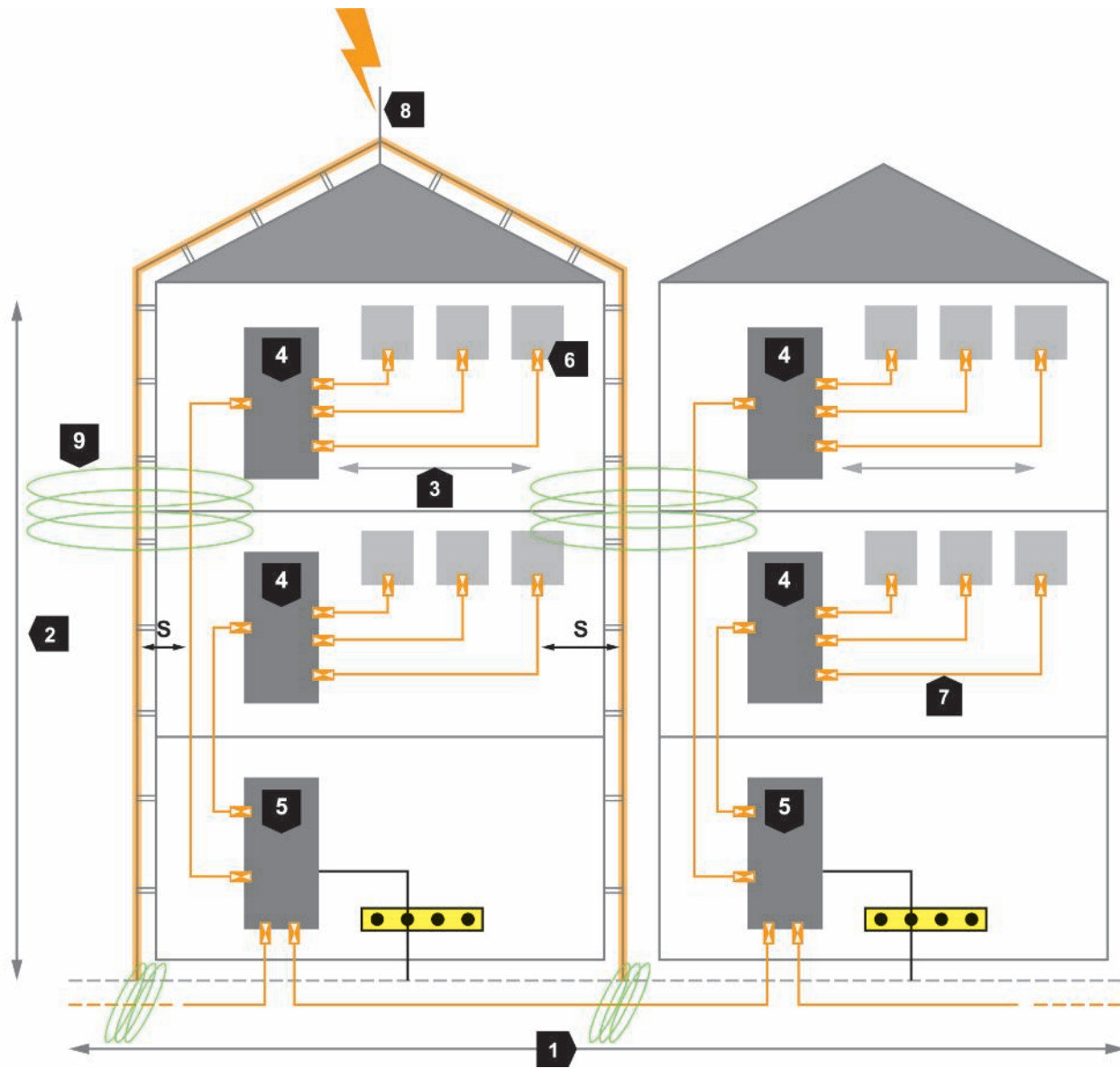

Lightning current and surge voltage in a building with structured cabling

<b>1</b>	Primary cabling
<b>2</b>	Secondary cabling
<b>3</b>	Tertiary cabling
<b>4</b>	FD: floor distributor
<b>5</b>	BD: building distributor
<b>6</b>	Surge protection
<b>7</b>	Data cables (orange)
<b>8</b>	External lightning protection (grey)
<b>9</b>	Inductive coupling

*The diagram only shows the protection of data cables. Energy cables also need to be protected.*

The connection of the primary cabling with the building distributor and the connections from building distributor to the floor distributor only need to be protected where copper cables are used. An exception is fibre optic cables incorporating metallic elements, e.g. rodent guards. These can couple lightning currents and surge voltages into the building. These metal elements must be connected to the equipotential bonding in such a way as to be able to withstand lightning current.

The following figures show how the OBO Net Defender can be used to protect network infrastructure and terminal devices:



*Suggested protection for terminal device. To keep the protection level low, the surge protection device uses the protective conductor of the PC case as the PE connection.*

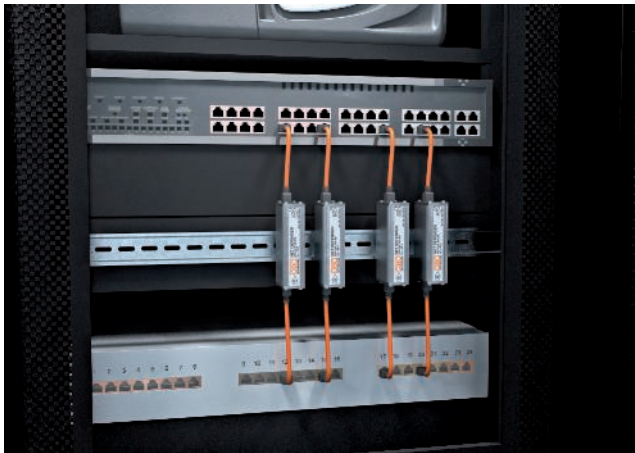

*Suggested protection for switch with patch panel. The surge protection devices are earthed via the DIN rail.*

## Selection aid, HF, video and satellite TV

Technology	Connection	Protected wires	Frequency range	Type	Gender	Item no.	Protection type
CATV	F	1	0-3.4 GHz	DS-F	plug/connector	5093275	Combination protection
	F	1	0-3.4 GHz	DS-F	connector/connector	5093272	Combination protection
DCF 77	SMA	1	0-3.7 GHz	DS-SMA	connector/connector	5093277	Combination protection
	BNC	1	0-2.2 GHz	DS-BNC	plug/connector	5093252	Combination protection
	BNC	1	0-2.2 GHz	DS-BNC	connector/connector	5093236	Combination protection
DCS 1800	BNC	1	0-2.2 GHz	DS-BNC	plug/plug	5093260	Combination protection
	SMA	1	0-3.7 GHz	DS-SMA	connector/connector	5093277	Combination protection
	N	1	0-3 GHz	DS-N	plug/connector	5093996	Combination protection
	N	1	0-3 GHz	DS-N	connector/connector	5093988	Combination protection
	BNC	1	0-2.2 GHz	DS-BNC	plug/connector	5093252	Combination protection
	BNC	1	0-2.2 GHz	DS-BNC	connector/connector	5093236	Combination protection
DOCSIS	BNC	1	0-2.2 GHz	DS-BNC	plug/plug	5093260	Combination protection
	Jul 16	1	0-3 GHz	DS-7 16	plug/connector	5093171	Combination protection
	F	1	0-3.4 GHz	DS-F	plug/connector	5093275	Combination protection
	F	1	0-3.4 GHz	DS-F	connector/connector	5093272	Combination protection
	F	1	0-3.4 GHz	DS-F	plug/connector	5093275	Combination protection
DVB-T / terrestrial	F	1	0-3.4 GHz	DS-F	connector/connector	5093272	Combination protection
	F	1	0.5-2.8 GHz	TV4+1	connector	5083400	Fine protection
	F	1	0-3.4 GHz	DS-F	plug/connector	5093275	Combination protection
DVB-T-2	N	1	0-6 GHz	DS-N-6	plug/connector	5093998	Combination protection
Radio installations	UHF	1	0-1.3 GHz	S-UHF	plug/connector	5093023	Combination protection
	UHF	1	0-1.3 GHz	S-UHF	connector/connector	5093015	Combination protection
	BNC	1	0-2.2 GHz	DS-BNC	plug/connector	5093252	Combination protection
	BNC	1	0-2.2 GHz	DS-BNC	connector/connector	5093236	Combination protection
	BNC	1	0-2.2 GHz	DS-BNC	plug/plug	5093260	Combination protection
	N	1	0-3 GHz	DS-N	plug/connector	5093996	Combination protection
	N	1	0-3 GHz	DS-N	connector/connector	5093988	Combination protection
	SMA	1	0-3.7 GHz	DS-SMA	connector/connector	5093277	Combination protection
	Jul 16	1	0-3 GHz	DS-7 16	plug/connector	5093171	Combination protection
	F	1	0-3.4 GHz	DS-F	plug/connector	5093275	Combination protection
	F	1	0-3.4 GHz	DS-F	connector/connector	5093272	Combination protection
	TNC	1	0-4 GHz	DS-TNC	plug/connector	5093270	Combination protection
GPS	SMA	1	0-3.7 GHz	DS-SMA	connector/connector	5093277	Combination protection
	BNC	1	0-2.2 GHz	DS-BNC	plug/connector	5093252	Combination protection
	BNC	1	0-2.2 GHz	DS-BNC	connector/connector	5093236	Combination protection
	BNC	1	0-2.2 GHz	DS-BNC	plug/plug	5093260	Combination protection
	N	1	0-3 GHz	DS-N	plug/connector	5093996	Combination protection
	N	1	0-3 GHz	DS-N	connector/connector	5093988	Combination protection
	Jul 16	1	0-3 GHz	DS-7 16	plug/connector	5093171	Combination protection
TNC	1	0-4 GHz	DS-TNC	plug/connector	5093270	Combination protection	

## Selection aid, HF, video and satellite TV

Technology	Connection	Protected wires	Frequency range	Type	Gender	Item no.	Protection type
GSM 900 / 1800	SMA	1	0–3.7 GHz	DS-SMA	connector/connector	509327 7	Combination protection
	BNC	1	0–2.2 GHz	DS-BNC	plug/connector	5093252	Combination protection
	BNC	1	0–2.2 GHz	DS-BNC	connector/connector	5093236	Combination protection
	BNC	1	0–2.2 GHz	DS-BNC	plug/plug	5093260	Combination protection
	N	1	0–3 GHz	DS-N	plug/connector	5093996	Combination protection
	N	1	0–3 GHz	DS-N	connector/connector	5093988	Combination protection
	TNC	1	0–4 GHz	DS-TNC	plug/connector	5093270	Combination protection
LTE	Jul 16	1	0–3 GHz	DS-7 16	plug/connector	5093171	Combination protection
	SMA	1	0–3.7 GHz	DS-SMA	connector/connector	5093277	Combination protection
	N	1	0–3 GHz	DS-N	plug/connector	5093996	Combination protection
	N	1	0–3 GHz	DS-N	connector/connector	5093988	Combination protection
	TNC	1	0–4 GHz	DS-TNC	plug/connector	5093270	Combination protection
PCS 1900	Jul 16	1	0–3 GHz	DS-7 16	plug/connector	5093171	Combination protection
	SMA	1	0–3.7 GHz	DS-SMA	connector/connector	5093277	Combination protection
	BNC	1	0–2.2 GHz	DS-BNC	plug/connector	5093252	Combination protection
	BNC	1	0–2.2 GHz	DS-BNC	connector/connector	5093236	Combination protection
	BNC	1	0–2.2 GHz	DS-BNC	plug/plug	5093260	Combination protection
	N	1	0–3 GHz	DS-N	plug/connector	5093996	Combination protection
PCS 1901	N	1	0–3 GHz	DS-N	connector/connector	5093988	Combination protection
	SMA	1	0–3.7 GHz	DS-SMA	connector/connector	5093277	Combination protection
	BNC	1	0–2.2 GHz	DS-BNC	plug/connector	5093252	Combination protection
	BNC	1	0–2.2 GHz	DS-BNC	connector/connector	5093236	Combination protection
	BNC	1	0–2.2 GHz	DS-BNC	plug/plug	5093260	Combination protection
	N	1	0–3 GHz	DS-N	plug/connector	5093996	Combination protection
PCS 1902	N	1	0–3 GHz	DS-N	connector/connector	5093988	Combination protection
	SMA	1	0–3.7 GHz	DS-SMA	connector/connector	5093277	Combination protection
	BNC	1	0–2.2 GHz	DS-BNC	plug/connector	5093252	Combination protection
	BNC	1	0–2.2 GHz	DS-BNC	connector/connector	5093236	Combination protection
PCS 1903	BNC	1	0–2.2 GHz	DS-BNC	plug/plug	5093260	Combination protection
	N	1	0–3 GHz	DS-N	plug/connector	5093996	Combination protection
	N	1	0–3 GHz	DS-N	connector/connector	5093988	Combination protection
	Jul 16	1	0–3 GHz	DS-7 16	plug/connector	5093171	Combination protection
PCS 1904	SMA	1	0–3.7 GHz	DS-SMA	connector/connector	5093277	Combination protection
	BNC	1	0–2.2 GHz	DS-BNC	plug/connector	5093252	Combination protection
	BNC	1	0–2.2 GHz	DS-BNC	connector/connector	5093236	Combination protection
	BNC	1	0–2.2 GHz	DS-BNC	plug/plug	5093260	Combination protection
PCS 1905	N	1	0–3 GHz	DS-N	plug/connector	5093996	Combination protection
	N	1	0–3 GHz	DS-N	connector/connector	5093988	Combination protection
	Jul 16	1	0–3 GHz	DS-7 16	plug/connector	5093171	Combination protection
	SMA	1	0–3.7 GHz	DS-SMA	connector/connector	5093277	Combination protection
PCS 1906	BNC	1	0–2.2 GHz	DS-BNC	plug/connector	5093252	Combination protection
	BNC	1	0–2.2 GHz	DS-BNC	connector/connector	5093236	Combination protection
	BNC	1	0–2.2 GHz	DS-BNC	plug/plug	5093260	Combination protection
	N	1	0–3 GHz	DS-N	plug/connector	5093996	Combination protection
Satellite TV	N	1	0–3 GHz	DS-N	connector/connector	5093988	Combination protection
	Jul 16	1	0–3 GHz	DS-7 16	plug/connector	5093171	Combination protection
	SMA	1	0–3.7 GHz	DS-SMA	connector/connector	5093277	Combination protection
	BNC	1	0–2.2 GHz	DS-BNC	plug/connector	5093252	Combination protection
C strip	BNC	1	0–2.2 GHz	DS-BNC	connector/connector	5093236	Combination protection
	BNC	1	0–2.2 GHz	DS-BNC	plug/plug	5093260	Combination protection
	N	1	0–3 GHz	DS-N	plug/connector	5093996	Combination protection
	N	1	0–3 GHz	DS-N	connector/connector	5093988	Combination protection
	Jul 16	1	0–3 GHz	DS-7 16	plug/connector	5093171	Combination protection
	SMA	1	0–3.7 GHz	DS-SMA	connector/connector	5093277	Combination protection
Sky DSL	F	1	0–3.4 GHz	DS-F	plug/connector	5093275	Combination protection
	F	1	0–3.4 GHz	DS-F	connector/connector	5093272	Combination protection
TETRA/BOS	F	1	0–3.4 GHz	DS-F	connector/connector	5093272	Combination protection
	F	1	0.5–2.8 GHz	TV4+1	connector	5083400	Fine protection
	F	3	0–2.5 GHz	FC-SAT-D	plug/connector	5092816	Fine protection
	N	1	0–6 GHz	DS-N-6	plug/connector	5093998	Combination protection



## Selection aid, HF, video and satellite TV

Technology	Connection	Protected wires	Frequency range	Type	Gender	Item no.	Protection type
TV	F	1	0–3.4 GHz	DS-F	plug/connector	5093275	Combination protection
	F	1	0–3.4 GHz	DS-F	connector/connector	5093272	Combination protection
	F	3	0–2.5 GHz	FC-TV-D	plug/connector	5092808	Fine protection
UMTS	SMA	1	0–3.7 GHz	DS-SMA	connector/connector	5093277	Combination protection
	BNC	1	0–2.2 GHz	DS-BNC	plug/connector	5093252	Combination protection
	BNC	1	0–2.2 GHz	DS-BNC	connector/connector	5093236	Combination protection
	BNC	1	0–2.2 GHz	DS-BNC	plug/plug	5093260	Combination protection
	N	1	0–3 GHz	DS-N	plug/connector	5093996	Combination protection
	N	1	0–3 GHz	DS-N	connector/connector	5093988	Combination protection
	TNC	1	0–4 GHz	DS-TNC	plug/connector	5093270	Combination protection
	Jul 16	1	0–3 GHz	DS-7 16	plug/connector	5093171	Combination protection
Video/CCTV	BNC	1	0–65 MHz	Coax B-E2 MF-F	plug/connector	5082432	Fine protection
	BNC	1	0–65 MHz	Coax B-E2 MF-C	plug/connector	5082430	Combination protection
	BNC	1	0–160 MHz	Coax B-E2 FF-F	plug/plug	5082434	Fine protection
Wi-Fi (2.4 GHz)	SMA	1	0–3.7 GHz	DS-SMA	connector/connector	5093277	Combination protection
	N	1	0–3 GHz	DS-N	plug/connector	5093996	Combination protection
	N	1	0–3 GHz	DS-N	connector/connector	5093988	Combination protection
	TNC	1	0–4 GHz	DS-TNC	plug/connector	5093270	Combination protection
Wi-Fi (> 5 GHz) Standard: a/h, n, ac	N	1	0–6 GHz	DS-N-6	plug/connector	5093998	Combination protection
WIMAX	N	1	0–6 GHz	DS-N-6	plug/connector	5093998	Combination protection

## Selection aid, data technology

Technology	Connection	Protected wires	Type	Item no.	Protection type	
Arcnet	BNC	1	CoaxB-E2 FF-F	5082434	Fine protection	
	BNC	1	CoaxB-E2 MF-F	5082432	Fine protection	
	BNC	1	CoaxB-E2 MF-C	5082430	Combination protection	
ATM	RJ45	8	ND-CAT6A/EA	5081800	Fine protection	
	RJ45	8	RJ45 S-ATM 8-F	5081990	Fine protection	
CCTV IP camera (without PoE)	RJ45	11	PND-2in1-C-RS	5081064	Combination protection	
CCTV IP camera (with PoE)	RJ45	8	ND-CAT6/E-F	5081802	Fine protection	
	RJ45	8	ND-CAT6/E-B	5081804	Basic protection	
Ethernet	Up to class 6A/EA	RJ45 (PoE)	8	ND-CAT6A/EA	5081800	Fine protection
	Up to class 6/E	RJ45 (PoE)	8	ND-CAT6/E-F	5081802	Fine protection
		RJ45 (PoE)	8	ND-CAT6/E-B	5081804	Basic protection
	Up to class 5/D	RJ45	8	RJ45 S-ATM 8-F	5081990	Fine protection
	10 Base 2/10 Base 5	BNC	1	CoaxB-E2 FF-F	5082434	Fine protection
		BNC	1	CoaxB-E2 MF-F	5082432	Fine protection
		BNC	1	CoaxB-E2 MF-C	5082430	Combination protection
FDDI, CDDI	RJ45	8	ND-CAT6A/EA	5081800	Fine protection	
	RJ45	8	RJ45 S-ATM 8-F	5081990	Fine protection	
Industrial Ethernet	RJ45	8	ND-CAT6A/EA	5081800	Fine protection	
	RJ45	8	RJ45 S-ATM 8-F	5081990	Fine protection	
	Wire-to-terminal connection	20	LSA-B-MAG	5084020	Combination protection	
	Wire-to-terminal connection	2	LSA-BF-180	5084024	Combination protection	
	Wire-to-terminal connection	2	LSA-BF-24	5084028	Combination protection	
Power over Ethernet	RJ45 (PoE)	8	ND-CAT6A/EA	5081800	Fine protection	
	RJ45 (PoE)	8	ND-CAT6/E-F	5081802	Fine protection	
	RJ45 (PoE)	8	ND-CAT6/E-B	5081804	Basic protection	

## Selection aid, data technology

Technology	Connection	Protected wires	Type	Item no.	Protection type
Token Ring	RJ45	8	ND-CAT6A/EA	5081800	Fine protection
	RJ45	8	RJ45 S-ATM 8-F	5081990	Fine protection
	BNC	1	CoaxB-E2 FF-F	5082434	Fine protection
	BNC	1	CoaxB-E2 MF-F	5082432	Fine protection
	BNC	1	CoaxB-E2 MF-C	5082430	Combination protection
RS232, V24	Wire-to-terminal connection	2	MDP-2 D-24-T	5098422	Combination protection
	Wire-to-terminal connection	4	MDP-4 D-24-EX	5098432	Combination protection
	Wire-to-terminal connection	2	FDB-2 24-M	5098380	Combination protection
	Wire-to-terminal connection	2	FDB-2 24-N	5098390	Combination protection
	Wire-to-terminal connection	2	FRD 24 HF	5098575	Fine protection
	Wire-to-terminal connection	4	MDP-4 D-24-T	5098431	Combination protection
	Wire-to-terminal connection	4	MDP-4 D-24-EX	5098432	Combination protection
	Wire-to-terminal connection	4	ASP-V24T 4	5083060	Fine protection
	Connector	9	SD09-V24 9	5080053	Fine protection
	Connector	15	SD15-V24 15	5080150	Fine protection
VG Any LAN	RJ45	8	ND-CAT6A/EA	5081800	Fine protection
Voice over IP	RJ45	8	ND-CAT6A/EA	5081800	Fine protection
4-wire information technology systems	RJ45	4	RJ45 S-E100 4-B	5081001	Basic protection
	RJ45	4	RJ45 S-E100 4-C	5081003	Combination protection
	RJ45	4	RJ45 S-E100 4-F	5081005	Fine protection
	RJ45	4	RJ45 S-E100 4-C	5081003	Combination protection
	RJ45	4	RJ45 S-E100 4-F	5081005	Fine protection

## Selection aid, telecommunications

Technology	Connection	Protected wires	Mounting/note	Type	Item no.	Protection type
a/b - analogue	RJ11	4	Various	RJ11-TELE 4-C	5081975	Combination protection
	RJ11	4	Various	RJ11-TELE 4-F	5081977	Fine protection
	RJ45	4	Various	RJ45-TELE 4-C	5081982	Combination protection
	RJ45	4	Various	RJ45-TELE 4-F	5081984	Fine protection
	Wire-to-terminal connection	2	DIN rail	TD-2/D-HS	5081694	Combination protection
	Wire-to-terminal connection	4	Wall mounting	TD-4/I	5081690	Combination protection
	Wire-to-terminal connection	4	Wall mounting	TD-4/I-TAE-F	5081692	Combination protection
	Wire-to-terminal connection	2	Wall mounting	TD-2D-V	5081698	Combination protection
	Wire-to-terminal connection	20	LSA	LSA-B-MAG	5084020	Basic protection
	Wire-to-terminal connection	2	LSA	LSA-BF-180	5084024	Combination protection
	Wire-to-terminal connection	2	DIN rail	TKS-B	5097976	Basic protection
	TAE/RJ11 / Connector	2	Socket	FC-TAE-D	5092824	Fine protection
ADSL	Wire-to-terminal connection	20	LSA	LSA-B-MAG	5084020	Basic protection
	Wire-to-terminal connection	2	LSA	LSA-BF-180	5084024	Combination protection
	Wire-to-terminal connection	2	DIN rail	TD-2/D-HS	5081694	Combination protection
	Wire-to-terminal connection	4	Wall mounting	TD-4/I	5081690	Combination protection
	Wire-to-terminal connection	4	Wall mounting	TD-4/I-TAE-F	5081692	Combination protection
	Wire-to-terminal connection	2	Wall mounting	TD-2D-V	5081698	Combination protection
	Wire-to-terminal connection	2	DIN rail	TKS-B	5097976	Basic protection
ADSL2+	Wire-to-terminal connection	20	LSA	LSA-B-MAG	5084020	Basic protection
	Wire-to-terminal connection	2	LSA	LSA-BF-180	5084024	Combination protection
	Wire-to-terminal connection	2	Wall mounting	TD-2D-V	5081698	Combination protection
	Wire-to-terminal connection	2	DIN rail	TKS-B	5097976	Basic protection
SDSL/SHDSL	Wire-to-terminal connection	20	LSA	LSA-B-MAG	5084020	Basic protection
	Wire-to-terminal connection	2	LSA	LSA-BF-180	5084024	Combination protection
	Wire-to-terminal connection	2	Wall mounting	TD-2D-V	5081698	Combination protection
	Wire-to-terminal connection	2	DIN rail	TKS-B	5097976	Basic protection
VDSL	Wire-to-terminal connection	20	LSA	LSA-B-MAG	5084020	Basic protection
	Wire-to-terminal connection	2	LSA	LSA-BF-180	5084024	Combination protection
	Wire-to-terminal connection	2	Wall mounting	TD-2D-V	5081698	Combination protection
	Wire-to-terminal connection	2	DIN rail	TKS-B	5097976	Basic protection

## Selection aid, telecommunications

Technology	Connection	Protected wires	Mounting/note	Type	Item no.	Protection type
VDSL2	Wire-to-terminal connection	20	LSA	LSA-B-MAG	5084020	Basic protection
	Wire-to-terminal connection	2	LSA	LSA-BF-180	5084024	Combination protection
	Wire-to-terminal connection	2	Wall mounting	TD-2D-V	5081698	Combination protection
	Wire-to-terminal connection	2	DIN rail	TKS-B	5097976	Basic protection
ISDN basic connection ( $U_{k0}$ )	Wire-to-terminal connection	2	DIN rail	TD-2/D-HS	5081694	Combination protection
	Wire-to-terminal connection	4	Wall mounting	TD-4/I	5081690	Combination protection
	Wire-to-terminal connection	4	Wall mounting	TD-4/I-TAE-F	5081692	Combination protection
	Wire-to-terminal connection	20	LSA / can only be used WITH LSA-A-LEI or LSA-T-LEI	LSA-B-MAG	5084020	Basic protection
	Wire-to-terminal connection	2	LSA / can only be used WITH LSA-A-LEI or LSA-T-LEI	LSA-BF-180	5084024	Combination protection
	Wire-to-terminal connection	2	DIN rail	TKS-B	5097976	Basic protection
	RJ11	4	Various	RJ11-TELE 4-C	5081975	Combination protection
	RJ11	4	Various	RJ11-TELE 4-F	5081977	Fine protection
	RJ45	4	Various	RJ45-TELE 4-C	5081982	Combination protection
ISDN basic connection ( $S_0$ )	RJ45	4	Various	RJ45-TELE 4-F	5081984	Fine protection
	RJ45	8	Various	ND-CAT6A/EA	5081800	Fine protection
	Wire-to-terminal connection	20	LSA	LSA-B-MAG	5084020	Basic protection
	Wire-to-terminal connection	2	LSA	LSA-BF-180	5084024	Combination protection
	Wire-to-terminal connection	2	LSA	LSA-BF-24	5084028	Combination protection
ISDN Primary Rate Interface ( $S_{2m}/U_{2m}$ )	RJ11/connector	4	Socket	FC-ISDN-D	5092812	Fine protection
	RJ11	4	Various	RJ11-TELE 4-C	5081975	Combination protection
	RJ11	4	Various	RJ11-TELE 4-F	5081977	Fine protection
	RJ45	4	Various	RJ45-TELE 4-C	5081982	Combination protection
	RJ45	4	Various	RJ45-TELE 4-F	5081984	Fine protection
	Wire-to-terminal connection	20	LSA	LSA-B-MAG	5084020	Basic protection
Datex-P	Wire-to-terminal connection	2	LSA	LSA-BF-180	5084024	Combination protection
	Spring terminal	4	DIN rail	MDP-4 D-24-T-10	5098433	Combination protection
G.703/G.704	RJ45	8	Various	RJ45 S-ATM 8-F	5081990	Fine protection
	Wire-to-terminal connection	20	LSA	LSA-B-MAG	5084020	Basic protection
	Wire-to-terminal connection	2	LSA	LSA-BF-180	5084024	Combination protection
	Wire-to-terminal connection	2	LSA	LSA-BF-24	5084028	Combination protection
	Wire-to-terminal connection	2	DIN rail	TKS-B	5097976	Basic protection
	Wire-to-terminal connection	2	DIN rail	TD-2/D-HS	5081694	Combination protection
	Wire-to-terminal connection	4	Wall mounting	TD-4/I	5081690	Combination protection
	Wire-to-terminal connection	4	Wall mounting	TD-4/I-TAE-F	5081692	Combination protection

## Selection aid, telecommunications

Technology	Connection	Protected wires	Mounting/note	Type	Item no.	Protection type
E1	RJ45	8	Various	RJ45 S-ATM 8-F	5081990	Fine protection
	Wire-to-terminal connection	20	LSA	LSA-B-MAG	5084020	Basic protection
	Wire-to-terminal connection	2	LSA	LSA-BF-180	5084024	Combination protection
	Wire-to-terminal connection	2	LSA	LSA-BF-24	5084028	Combination protection
Various telecom systems	Wire-to-terminal connection	20	LSA	LSA-B-MAG	5084020	Basic protection
	Wire-to-terminal connection	2	LSA	LSA-BF-180	5084024	Combination protection
	Wire-to-terminal connection	2	LSA	LSA-BF-24	5084028	Combination protection
	Wire-to-terminal connection	2	DIN rail	TKS-B	5097976	Basic protection
	Wire-to-terminal connection	2	DIN rail	TD-2/D-HS	5081694	Combination protection
	Wire-to-terminal connection	4	Wall mounting	TD-4/I	5081690	Combination protection
	Wire-to-terminal connection	4	Wall mounting	TD-4/I-TAE-F	5081692	Combination protection
	RJ11	4	Various	RJ11-TELE 4-C	5081975	Combination protection
	RJ11	4	Various	RJ11-TELE 4-F	5081977	Fine protection
	RJ45	4	Various	RJ45-TELE 4-C	5081982	Combination protection
	RJ45	4	Various	RJ45-TELE 4-F	5081984	Fine protection
	RJ45	8	Various	RJ45 S-ATM 8-F	5081990	Fine protection
	RJ45	8	Various	ND-CAT6A/EA	5081800	Fine protection
	RJ11/connector	4	Socket	FC-RJ-D	5092828	Fine protection

## Selection aid, measurement and control systems

Interface	Connection	Protected wires	Mounting	#EX icon	FS**	Type	Item no.	Protection type
RS232, V24	Spring terminal	2	DIN rail			MDP-2 D-24-T	5098422	Combination protection
	Spring terminal	4	DIN rail	✓		MDP-4 D-24-EX	5098432	Combination protection
	Spring terminal	4	DIN rail			MDP-4 D-24-T	5098431	Combination protection
	Spring terminal	4	DIN rail	✓		MDP-4 D-24-EX	5098432	Combination protection
	Wire-to-terminal connection	2	Thread - metric	✓		FDB-2 24-M	5098380	Fine protection
	Wire-to-terminal connection	2	Thread - NPT	✓		FDB-2 24-N	5098390	Fine protection
	Screw terminal	2	DIN rail			FRD 24	5098514	Fine protection
	Screwless terminal	4	Miscellaneous			ASP-V24T 4	5083060	Fine protection
	SUB-D-9	9	Connector			SD09-V24 9	5080053	Fine protection
	SUB-D-15	15	Connector			SD15-V24 15	5080150	Fine protection
RS422, V11	Wire-to-terminal connection	2	Thread - metric	✓		FDB-2 24-M	5098380	Fine protection
	Wire-to-terminal connection	2	Thread - NPT	✓		FDB-2 24-N	5098390	Fine protection
	Screw terminal	2	DIN rail			FRD 24	5098514	Combination protection
	Spring terminal	2	DIN rail			MDP-2 D-24-T	5098422	Combination protection
	Spring terminal	2	DIN rail	✓		MDP-4 D-24-EX	5098432	Combination protection
	Spring terminal	4	DIN rail			MDP-4 D-24-T	5098431	Combination protection
	Spring terminal	4	DIN rail	✓		MDP-4 D-24-EX	5098432	Combination protection
RS485	Spring terminal	2	DIN rail			MDP-2 D-5-T	5098404	Combination protection
	Spring terminal	2	DIN rail	✓		MDP-4 D-5-EX	5098432	Combination protection
	Spring terminal	4	DIN rail			MDP-4 D-5-T	5098411	Combination protection
	Spring terminal	4	DIN rail	✓		MDP-4 D-5-EX	5098432	Combination protection
	Screw terminal	2	DIN rail			FRD 5 HF	5098571	Combination protection
	SUB-D-9	9	Connector			SD-09-V11 9	5080061	Fine protection
Binary signals, ground potential-free	Spring terminal	2	DIN rail			MDP-2 D-24-T	5098422	Combination protection
	Spring terminal	2	DIN rail	✓		MDP-4 D-24-EX	5098432	Combination protection
	Wire-to-terminal connection	2	Thread - metric			FDB-2 24-M	5098380	Combination protection
	Wire-to-terminal connection	2	Thread - NPT			FDB-2 24-N	5098390	Combination protection
	Screw terminal	2	DIN rail			FRD 5 HF	5098571	Combination protection
	Screw terminal	2	DIN rail			FRD 5	5098492	Combination protection
	Screw terminal	2	DIN rail			FLD 5	5098600	Combination protection
Binary signals, common reference potential	Screw terminal	2	DIN rail			FRD 2-24	5098727	Combination protection
	Screw terminal	2	DIN rail			FLD 2-24	5098816	Combination protection
** Remote signalling								

## Selection aid, measurement and control systems

Interface	Connection	Protected wires	Mounting	#EX icon	FS**	Type	Item no.	Protection type
(0)4-20 mA	Spring terminal	2	DIN rail			MDP-2 D-24-T	5098422	Combination protection
	Spring terminal	2	DIN rail	✓		MDP-4 D-24-EX	5098432	Combination protection
	Spring terminal	4	DIN rail			MDP-4 D-24-T	5098431	Combination protection
	Spring terminal	4	DIN rail	✓		MDP-4 D-24-EX	5098432	Combination protection
	Wire-to-terminal connection	2	Thread - metric	✓		FDB-2 24-M	5098380	Fine protection
	Wire-to-terminal connection	2	Thread - NPT	✓		FDB-2 24-N	5098390	Fine protection
	Wire-to-terminal connection	2	LSA			LSA-B-MAG	5084020	Basic protection
	Wire-to-terminal connection	2	LSA			LSA-BF-24	5084028	Combination protection
	Spring terminal	2	DIN rail			FLD 24	5098611	Fine protection
0-10 V	Spring terminal	2	DIN rail			MDP-2 D-24-T	5098422	Combination protection
	Spring terminal	2	DIN rail	✓		MDP-4 D-24-EX	5098432	Combination protection
	Wire-to-terminal connection	2	Thread - metric	✓		FDB-2 24-M	5098380	Fine protection
	Wire-to-terminal connection	2	Thread - NPT	✓		FDB-2 24-N	5098390	Fine protection
	Screw terminal	2	DIN rail			FLD 24	5098611	Combination protection
Various DC circuits	Ground potential-free	Spring terminal	2	DIN rail		FLD 5	5098600	Combination protection
		Spring terminal	2	DIN rail		FLD 12	5098603	Combination protection
		Spring terminal	2	DIN rail		FLD 24	5098611	Combination protection
		Spring terminal	2	DIN rail		FLD 48	5098630	Combination protection
		Spring terminal	2	DIN rail		FLD 60	5098638	Combination protection
		Spring terminal	2	DIN rail		FLD 110	5098646	Combination protection
	Common reference potential	Spring terminal	2	DIN rail		FLD 2-5	5098867	Combination protection
	Common reference potential	Spring terminal	2	DIN rail		FLD 2-12	5098808	Combination protection
		Spring terminal	2	DIN rail		FLD 2-24	5098816	Combination protection
		Spring terminal	2	DIN rail		FLD 2-48	5098824	Combination protection
		Spring terminal	2	DIN rail		FLD 2-110	5098859	Combination protection
Various frequency-dependent circuits	Ground potential-free	Spring terminal	2	DIN rail		FRD 5 HF	5098571	Combination protection
		Spring terminal	2	DIN rail		FRD 24 HF	5098575	Combination protection
		Spring terminal	2	DIN rail		FRD 5	5098492	Combination protection
		Spring terminal	2	DIN rail		FRD 12	5098506	Combination protection
		Spring terminal	2	DIN rail		FRD 24	5098514	Combination protection
		Spring terminal	2	DIN rail		FRD 48	5098522	Combination protection
		Spring terminal	2	DIN rail		FRD 110	5098557	Combination protection
** Remote signalling								



## Selection aid, measurement and control systems

Interface	Connection	Protected wires	Mounting	#EX icon	FS*	Type	Item no.	Protection type
2-pin power supplies 5 V	Spring terminal	4	DIN rail			MDP-4 D-5-T-10	5098413	Combination protection
2-pin power supplies 12 V	Screw terminal	2	DIN rail			VF12-AC-DC	5097453	Fine protection
	Screw terminal	2	DIN rail		✓	VF12-AC/DC-FS	5097454	Fine protection
2-pin power supplies 24 V	Screw terminal	2	DIN rail			VF24-AC/DC	5097607	Fine protection
	Screw terminal	2	DIN rail		✓	VF24-AC/DC-FS	5097820	Fine protection
2-pin power supplies 48 V	Screw terminal	2	DIN rail			VF48-AC/DC	5097615	Fine protection
	Screw terminal	2	DIN rail		✓	VF48-AC/DC-FS	5097822	Fine protection
2-pin power supplies 60 V	Screw terminal	2	DIN rail			VF60-AC/DC	5097623	Fine protection
	Screw terminal	2	DIN rail		✓	VF60-AC/DC-FS	5097824	Fine protection
2-pin power supplies 110 V	Screw terminal	2	DIN rail			VF110-AC/DC	5097631	Fine protection
2-pin power supplies 230 V	Screw terminal	2	DIN rail			VF230-AC/DC	5097650	Fine protection
	Screw terminal	2	DIN rail		✓	VF230-AC-FS	5097858	Fine protection
	Screw terminal	2	DIN rail		✓ **	VF2-230-AC/DC-FS	5097939	Fine protection
PT 100	Spring terminal	2	DIN rail			FLD 24	5098611	Combination protection
	Spring terminal	2	DIN rail			FLD 2-24	5098816	Combination protection
	Spring terminal	4	DIN rail			MDP-4 D-24-T-10	5098433	Combination protection
PT 1000	Spring terminal	2	DIN rail			FLD 24	5098611	Combination protection
	Spring terminal	2	DIN rail			FLD 2-24	5098816	Combination protection
	Spring terminal	4	DIN rail			MDP-4 D-24-T-10	5098433	Combination protection
TTL	Spring terminal	2	DIN rail			FRD 12	5098603	Combination protection
	Spring terminal	2	DIN rail			MDP-2 D-24-T	5098422	Combination protection
	SUB-D-9	9	Connector			SD09-V24 9	5080053	Fine protection
	SUB-D-15	15	Connector			SD15-V24 15	5080150	Fine protection
* Remote signalling, ** Leakage current-free								

## Selection aid, bus systems

Interface	Connection	Protected wires	Mounting	#EX icon	Testable	FS*	Type	Item no.	Protection type
ADVANT	Spring terminal	4	DIN rail		✓		MDP-4 D-24-T	5098431	Combination protection
ARCNET	RJ45	8	DIN rail				ND-CAT6A/EA	5081800	Fine protection
AS-I	Data cable	Spring terminal	2	DIN rail		✓	MDP-2 D-24-T-10	5098425	Combination protection
	Power supply	Spring terminal	2	DIN rail		✓	VF24-AC/DC	5097607	Fine protection
		Spring terminal	2	DIN rail		✓	VF24-AC/DC-FS	5097820	Fine protection
BITBUS	Spring terminal	4	DIN rail		✓		MDP-4 D-24-T	5098431	Combination protection
BLN	Spring terminal	2	DIN rail		✓		MDP-2 D-24-T	5098422	Combination protection
	Spring terminal	2	DIN rail				FRD 24 HF	5098575	Fine protection
CANBus	Data cable	Spring terminal	3	DIN rail		✓	MDP-3 D-5-T	5098407	Combination protection
	Power supply	Spring terminal	2	DIN rail		✓	VF24-AC/DC	5097607	Fine protection
		Spring terminal	2	DIN rail		✓	VF24-AC/DC-FS	5097820	Fine protection
CAN open	Data cable	Spring terminal	4	DIN rail		✓	MDP-4 D-24-T	5098431	Combination protection
	Power supply	Spring terminal	2	DIN rail		✓	VF24-AC/DC	5097607	Fine protection
		Spring terminal	2	DIN rail		✓	VF24-AC/DC-FS	5097820	Fine protection
C-BUS	Spring terminal	2	DIN rail				MDP-2 D-24-T	5098422	Combination protection
	Spring terminal	2	DIN rail				FRD 24 HF	5098575	Combination protection
CC-Link	Data cable	Spring terminal	4	DIN rail		✓	MDP-4-D-24-T	5098431	Combination protection
	Power supply	Spring terminal	2	DIN rail		✓	VF24-AC/DC	5097607	Fine protection
		Spring terminal	2	DIN rail		✓	VF24-AC/DC-FS	5097820	Fine protection
Data Highway Plus	Spring terminal	4	DIN rail		✓		MDP-4 D-24-T	5098431	Combination protection
Device Net	Data cable	Spring terminal	4	DIN rail		✓	MDP-4 D-24-T	5098431	Combination protection
	Power supply	Spring terminal	2	DIN rail		✓	VF24-AC/DC	5097607	Fine protection
		Spring terminal	2	DIN rail		✓	VF24-AC/DC-FS	5097820	Fine protection
Dupline	Spring terminal	2	DIN rail		✓		MDP-2 D-24-T	5098422	Combination protection
	Spring terminal	2	DIN rail				FRD 24 HF	5098575	Combination protection
eBUS	Spring terminal	2	DIN rail		✓		MDP-2 D-48-T	5098442	Combination protection
	Spring terminal	2	DIN rail				FRD 48	5098522	Fine protection
EIB	Spring terminal	2	DIN rail		✓		MDP-2 D-24-T-10	5098425	Combination protection
	Spring terminal	4	DIN rail		✓		MDP-4 D-24-T-10	5098433	Combination protection
	Spring terminal	2	DIN rail				TKS-B	5097976	Basic protection
ET 200	Spring terminal	2	DIN rail				FRD 5	5098492	Fine protection
	Spring terminal	2	DIN rail		✓		MDP-2 D-5-T	5098404	Combination protection
	Spring terminal	4	DIN rail		✓		MDP-4 D-24-T	5098431	Combination protection
FIPIO/FIPWAY	Spring terminal	4	DIN rail		✓		MDP-4 D-5-T	5098411	Combination protection
Foundation Fieldbus	Spring terminal	2	DIN rail		✓		MDP-2 D-48-T	5098450	Combination protection
	Spring terminal	2	DIN rail	✓	✓		MDP-4 D-48-EX	5098452	Combination protection
	Spring terminal	2	Thread - metric	✓			FDB-2 24-M	5098380	Combination protection
	Spring terminal	2	Thread - NPT	✓			FDB-2 24-N	5098390	Combination protection
FSK	Spring terminal	2	DIN rail				FRD 5	5098492	Fine protection
	Spring terminal	2	DIN rail		+		MDP-2 D-5-T	5098404	Combination protection
Genius	Spring terminal	4	DIN rail		+		MDP-4 D-24-T	5098431	Combination protection
* Remote signalling									

## Selection aid, bus systems

Interface	Connection	Protected wires	Mounting	#EX icon	Testable	Type	Item no.	Protection type
HARD	Spring terminal	2	DIN rail			FRD 24	5098514	Combination protection
	Spring terminal	2	DIN rail		✓	MDP-2 D-24-T	5098422	Combination protection
	Spring terminal	4	DIN rail		✓	MDP-4 D-24-T	5098431	Combination protection
	Spring terminal	4	DIN rail	✓		MDP-4 D-24-EX	5098432	Combination protection
	Wire-to-terminal connection	4	Thread – metric	✓		FDB-2 24-M	5098380	Fine protection
	Wire-to-terminal connection	4	Thread – NPT	✓		FDB-2 24-N	5098390	Fine protection
IEC bus	Spring terminal	4	DIN rail		✓	MDP-4 D-5-T	5098411	Combination protection
Interbus Inline (I/O)s	Spring terminal	4	DIN rail		✓	MDP-4 D-24-T	5098422	Combination protection
Interbus Loop	Spring terminal	2	DIN rail		✓	MDP-4 D-24-T-10	5098433	Combination protection
KNX	Spring terminal	2	DIN rail			TKS-B	5097976	Basic protection
LON	Spring terminal	2	DIN rail			FRD 48	5098522	Combination protection
	Spring terminal	2	DIN rail		✓	MDP-2 D-48-T	5098442	Combination protection
LRE	Spring terminal	2	DIN rail			FRD 5	5098492	Combination protection
	Spring terminal	2	DIN rail		✓	MDP-2 D-5-T	5098404	Combination protection
LUXMATE	Spring terminal	4	DIN rail			MDP-4 D-5-T	5098411	Combination protection
M-BUS	Spring terminal	2	DIN rail			FRD 24	5098514	Combination protection
	Spring terminal	2	DIN rail		✓	MDP-2 D-24-T	5098422	Combination protection
Melsec Net 2	BNC	1	Miscellaneous			DS-BNC m/f	5093252	Basic protection
Melsec Net 3	BNC	1	Miscellaneous			DS-BNC f/f	5093236	Basic protection
Melsec Net 4	BNC	1	Miscellaneous			DS-BNC f/m	5093260	Basic protection
MODBUS	Spring terminal	4	DIN rail		✓	MDP-4 D-24-T	5098431	Combination protection
MPI bus	Spring terminal	2	DIN rail			FRD 5	5098492	Combination protection
	Spring terminal	2	DIN rail		✓	MDP-2 D-5-T	5098404	Combination protection
	Spring terminal	4	DIN rail		✓	MDP-4 D-5-T	5098411	Combination protection
N1 LAN	Spring terminal	2	DIN rail			FRD 5	5098492	Combination protection
	Spring terminal	2	DIN rail		✓	MDP-2 D-5-T	5098404	Combination protection
	Spring terminal	20	DIN rail			LSA-B-MAG	5084020	Basic protection
	Spring terminal	2	DIN rail			LSA-BF-24	5084028	Combination protection
N2 bus	Spring terminal	2	DIN rail			FRD 2-5	5098794	Combination protection
	Spring terminal	2	DIN rail		✓	MDP-2 D-5-T	5098404	Combination protection
novaNet	Spring terminal	2	DIN rail			FRD 12	5098603	Combination protection
	Spring terminal	2	DIN rail		✓	MDP-2 D-24-T	5098422	Combination protection

## Selection aid, bus systems

Interface		Connection	Protected wires	Mounting	#EX icon	Testable	FS*	Type	Item no.	Protection type
P-BUS, Process Bus, Panel Bus	Data cable	Spring terminal	2	DIN rail				FRD 24 HF	5098575	Combination protection
		Spring terminal	2	DIN rail		✓		MDP-2 D-24-T	5098422	Combination protection
	Power supply	Spring terminal	2	DIN rail		✓		VF24-AC/DC	5097607	Fine protection
		Spring terminal	2	DIN rail		✓	✓	VF24-AC/DC-FS	5097820	Fine protection
P-NET		Spring terminal	4	DIN rail		✓		MDP-4 D-24-T	5098431	Combination protection
Procontic CS31		Spring terminal	2	DIN rail				FRD 12	5098603	Combination protection
		Spring terminal	2	DIN rail		✓		MDP-2 D-24-T	5098422	Combination protection
Procontic T200		Spring terminal	4	DIN rail		✓		MDP-4 D-24-T	5098431	Combination protection
Profibus DP		Spring terminal	2	DIN rail		✓		MDP-2 D-5-T	5098404	Combination protection
		Screw terminal	2	DIN rail				FRD 5 HF	5098571	Combination protection
		SUB-D-9	9	Connector				SD09-V24 9	5080053	Fine protection
Profibus PA		Spring terminal	2	DIN rail		✓		MDP-2 D-48-T	5098442	Combination protection
		Spring terminal	4	DIN rail	✓			MDP-4 D-48-EX	5098452	Combination protection
		Wire-to-terminal connection	2	Metric thread	✓			FDB-2 24-M	5098380	Fine protection
		Wire-to-terminal connection	2	Thread – NPT	✓			FDB-2 24-N	5098390	Fine protection
Profinet		Spring terminal	8	DIN rail				ND-CAT6A/EA	5081800	Fine protection
SafetyBUS p		Spring terminal	4	DIN rail		✓		MDP-4 D-24-T	5098431	Combination protection
SDLC		Spring terminal	4	DIN rail		✓		MDP-4 D-24-T	5098431	Combination protection
SIGMALOOP (SIGMASYS)		Spring terminal	2	DIN rail				FRD 24	5098514	Combination protection
		Spring terminal	2	DIN rail		✓		MDP-4 D-24-T	5098431	Combination protection
SIGMANET (SIGMASYS)		Spring terminal	2	DIN rail				FRD 24	5098514	Combination protection
		Spring terminal	2	DIN rail		✓		MDP-4 D-24-T	5098431	Combination protection
SINEC L1	SINEC L2	Spring terminal	4	DIN rail		✓		MDP-4 D-5-T	5098411	Combination protection
* Remote signalling										

## Selection aid, bus systems

Interface	Connection	Protected wires	Mounting	#EX icon	Testable	Type	Item no.	Protection type
SINEC L2	Spring terminal	2	DIN rail			FRD 5 HF	5098571	Combination protection
	Spring terminal	2	DIN rail		✓	MDP-4 D-5-T	5098411	Combination protection
	SUB-D-9	9	Connector			SD09-V24 9	5080053	Fine protection
SS97 SINIX	Spring terminal	4	DIN rail		✓	MDP-4 D-24-T	5098431	Combination protection
SUCONET	Spring terminal	4	DIN rail		✓	MDP-4 D-24-T	5098431	Combination protection
	Crimp clamp	20	LSA			LSA-B-MAG	5084020	Basic protection
	Crimp clamp	2	LSA			LSA-BF-24	5084028	Fine protection
TTL	Spring terminal	2	DIN rail			FRD 24	5098514	Combination protection
	Spring terminal	2	DIN rail		✓	MDP-2 D-24-T	5098422	Combination protection
	SUB-D-9	9	Connector			SD09-V24 9	5080053	Fine protection
	SUB-D-15	15	Connector			SD15-V24 15	5080150	Fine protection
U-BUS	Spring terminal	4	DIN rail			2x TKS-B	5097976	Basic protection

# 4

Every lightning protection system must undergo an acceptance test following installation. Regular tests must also be carried out to ensure correct functioning. In addition, the entire system must be checked following any lightning or surge voltage event. According to the current lightning protection standard, IEC 62305, the air-termination and conduction equipment, the earthing system and the equipotential bonding must be tested.

In addition to a visual inspection of the system and its compliance with the relevant documentation, volume resistance must also be measured. The documentation should be updated following each test or service.

## Chapter 4: Testing, maintenance and documentation

4	Testing, maintenance and documentation	272
4.1	External lightning protection system	273
4.2	Internal lightning protection system	276

## 4. Testing, maintenance and documentation

Lightning protection systems must, even after the acceptance test, be checked at regular intervals to ensure correct functioning, establish any faults and carry out any necessary repairs. The test involves checking the technical documentation, a visual inspection and measuring of the lightning protection system.

The testing and servicing activities should be carried out on the basis of the standard and the technical principles of IEC 62305-3.

The tests also comprise checking the internal lightning protection system. This includes checking the lightning protection equipotential bonding and the connected lightning and surge arrestors. A test report or test log is used to record the testing and servicing of lightning protection systems and must be updated or re-created at each test/service.

*The owner or operator of a building structure is responsible for maintaining safety and ensuring immediate rectification of any faults.*

*Testing must be carried out by specialist personnel.*





Separation point on a metal facade

## 4.1 External lightning protection system

### Testing criteria

- Checking all records and documentation, including compliance with the standards.
- Checking the general condition of air-termination and conductor systems and all connection components (no loose connections), and volume resistances.
- Checking the earthing system and the earthing resistors incl. transitions and connections.
- Checking internal lightning protection, incl. surge arrestors and fuses.
- Check the general level of corrosion.
- Check the security of fastening the cables of the LPS and its components.
- Check the documentation of all modifications and upgrades to LPS and modifications to buildings.

*Critical systems (e.g. installations at risk from explosion) must be checked annually.*

Lightning protection class	Visual inspection (year)	Comprehensive visual inspection (year)	Comprehensive visual inspection in critical situations (year)
I and II	1	2	1
III and IV	2	4	1

Table 4.1: Critical situations include structures containing sensitive systems, or office and commercial buildings or places in which a large number of people meet.



*Components for lightning protection systems are tested according to IEC 62561-1.*

BET lightning current generator

Components for lightning protection systems are tested for functionality according to IEC 62561-1 – Requirements for connection components. After a conditioning phase lasting 10 days, the components are impacted with three lightning strikes. The lightning protection components for air-termination systems are tested with  $3 \times I_{imp}$  100 kA (10/350). This corresponds to test class H.

Components for conductors along which the lightning current can spread (at least two arrestors) and connections in the earthing system are tested with  $3 \times I_{imp}$  50 kA (10/350). This corresponds to test class N.

Test class	Tested with	Application
H according to IEC 62561-1	$3 \times I_{imp}$ 100 kA (10/350)	Air-termination system
N according to IEC 62561-1	$3 \times I_{imp}$ 50 kA (10/350)	Multiple applications along which the lightning current can spread, at least two arrestors

Table 4.2: Test classes of connecting components

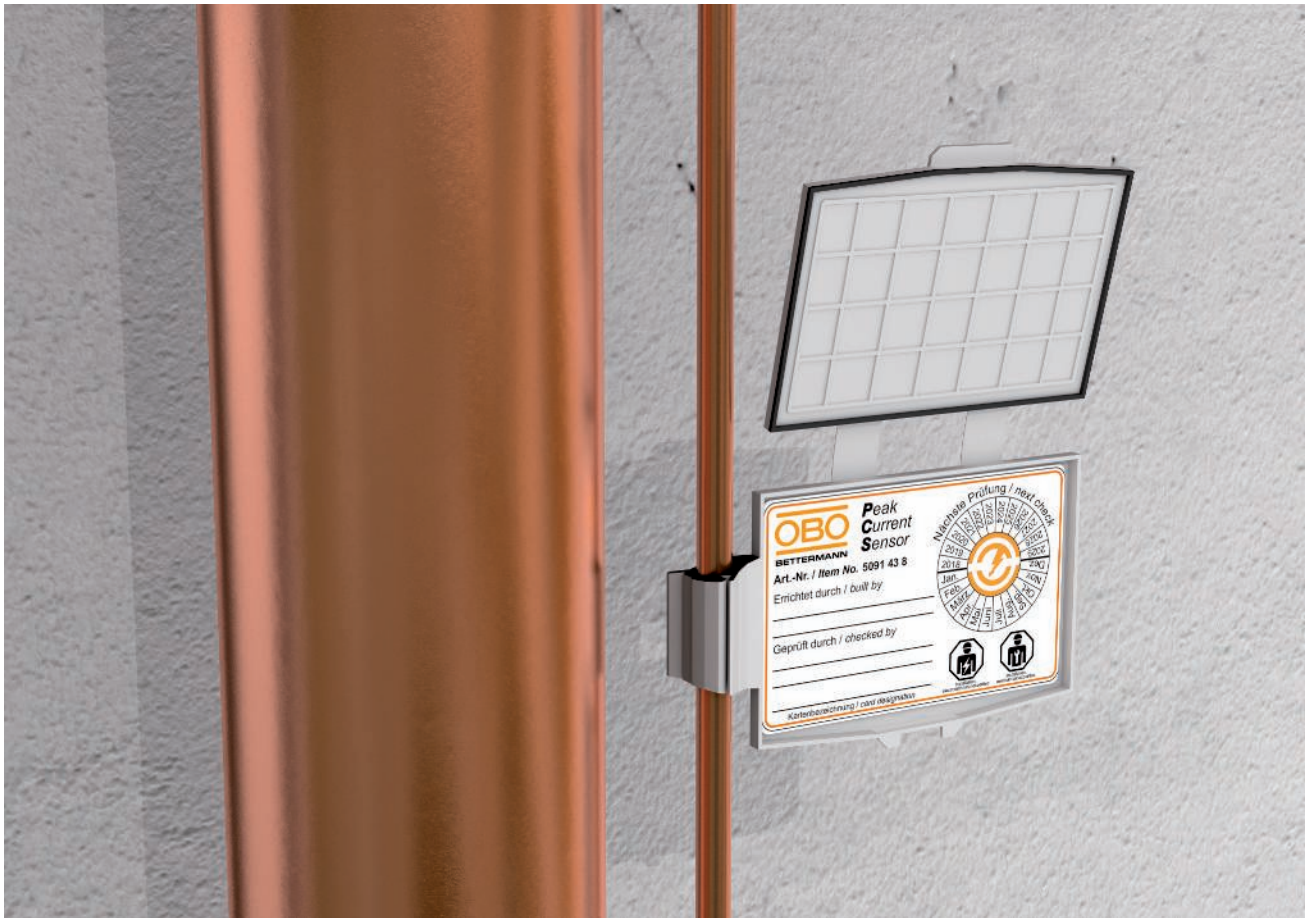

PCS sensor on a down-conductor

### Testing of lightning protection systems with the PCS system

The Peak Current Sensor (PCS) records and stores pulsed currents in the form of a magnetic card. This is a method of monitoring whether lightning has hit the lightning current system and which maximum lightning current has occurred. If the PCS system is mounted between the interface from equipotential bonding to earthing system, the coupled lightning current in a building can also be measured. The results can provide information on potential damage in the electrical installation.

The PCS card is mounted by snapping a card holder onto the round conductor at a defined distance. The measuring range of the card is from 3 to 120 kA. The magnetic card reader offers the possibility of evaluating the peak current sensors. The corresponding peak current value is shown on the display.

Alternatively, OBO Bettermann can include the readout of the data as an additional service. If this is desired, please contact your OBO representative or the appropriate subsidiary.



Life Control testing unit

*This innovation from OBO Bettermann comes complete with a high-quality testing case for safe transportation and the documentation of test results.*

## 4.2 Internal lightning protection system

### Testing surge protection devices within data cables

It is often necessary to check the function of the surge protection devices within the data cable. It is particularly important to check that the actual test of the protection devices has no negative influence on the data signal.

The Life Control testing device developed by OBO Bettermann allows protection devices to be tested in their installed state without this affecting the data signal. Contact is made with the lightning barrier in its installed state by using a narrow testing pin. The integrated microprocessor shows the test result on the OLED display; acoustic signals supplement the information on the display. A further feature is an LED in the testing pin that can be activated if desired to provide orientation in even the darkest switching cabinets.

### Testing of the arrester upper parts V50, V25, V20 and V10

The ISOLAB testing unit allows the checking of the arrester upper parts V50, V25, V20 and V10. A rotary controller allows the selection of the appropriate OBO arrester. Then, the upper part of the appropriate combination and/or surge arrester is placed in the appropriate opening in the device. The function of the varistor is then checked by pressing the test button. Besides arrester testing, the ISOLAB also offers insulation testing according to VDE 0100-610.

### Testing surge protection

The electrical system should be checked at regular intervals. The SPDs for the power supply usually have a visual status display and can thus be checked very easily. A complete check of all surge protection measures is possible, e.g. in the context of the E-CHECK, the test seal for electrical installations and devices.

Information at:

[www.elektrohandwerk.de/privat/themen/e-check.html](http://www.elektrohandwerk.de/privat/themen/e-check.html)



# 5

## Chapter 5: Brief glossary of surge protection

Term	Standard text
Arrestor (SPD= surge protective device)	Arrestors (in the standard = surge protection devices (SPD)) consist of voltage-dependent resistors and/or spark gaps. Both elements can be connected either in series or in parallel, or used individually. SPDs protect other electrical equipment and systems from surge voltages and an insulation failure.
Arrestor measured-voltage $U_c$	In SPDs without a spark gap, the measured voltage is the maximum permissible effective value of network voltage at the arrestor terminals. The measured voltage can be applied constantly to the arrestor without changing its operating characteristics.
Cut-off unit	The cut-off unit cuts the SPD off from the mains/earthing system in case of overloading, to prevent a risk of fire while at the same time signalling that the protection device has been switched off.
100% response lightning impulse voltage	The 100% response lightning impulse voltage is the value of the lightning impulse voltage 1.2/50 $\mu$ s, causing the SPD to switch. At this test voltage, the surge protection device must respond ten times when exposed to ten loads.
Response time ( $t_a$ )	The response time essentially characterises the response behaviour of the individual protection elements used in SPDs. Depending on the rate of rise of the surge voltage $du/dt$ or surge current $di/dt$ , response times can vary within specific boundaries.
Lightning protection equipotential bonding system	The lightning protection equipotential bonding system is an important element for reducing the risk of fire or explosion in the area/building to be protected. The lightning protection equipotential bonding is produced using equipotential bonding cables or SPDs that connect the external lightning protection system, metal components of the building or space, installations; extraneous conductive parts and the electrical energy and telecommunication systems, with each other.
Lightning protection system (LPS)	The term lightning protection system (LPS) refers to the entire system used to protect a room or building against the effects of a lightning strike. It refers to both external and internal lightning protection.
Lightning protection zone (LPZ)	The term lightning protection zone (LPZ) describes an individual area in which the electromagnetic environment of the lightning is defined and brought under control. At transitions between zones, all cables and metal components must be incorporated into the equipotential bonding.
Lightning surge current ( $I_{imp}$ )	The lightning surge current (lightning current carrying capacity per path) is a standardised surge current curve with the waveform 10/350 $\mu$ s. Through its parameters – peak value, charge and specific energy – it reproduces the load produced by a natural lightning current. Type 1 lightning current arrestors (previously requirement class B) must be able to arrest such lightning currents without being destroyed.
Volume resistance per path, series resistance	The volume resistance per path is the ohmic resistance increase per wire produced by the use of the surge voltage protection device.
Error current protection device (RCD)	Device to protect against electric shock and fires (e.g. the "former" FI protection switch is currently called RCD (Residual Current Device)).
Insulation coordination	The insulation and the maximum voltage resistance (insulation resistance) of the electrical system is ensured through the use of an SPD with a lower protection level (voltage limit).
Short-circuit resistance	The surge protection device must be able to conduct the short-circuit current, until it is either interrupted by the device itself or by an internal or external cut-off unit or by the mains-side over-current protection (e.g. back-up fuse).
LPZ	See "Lightning protection zone"
Nominal discharge current ( $I_n$ )	Peak value of the current flowing through the SPD with the wave shape 8/20. It is used to classify the testing of surge arrestors of type 2 (formerly requirements Class C)
Nominal frequency ( $f_n$ )	The nominal frequency is the frequency of a device given by the manufacturer for normal operation.

Term	Standard text
Nominal voltage ( $U_n$ )	The nominal voltage is the voltage value for which a resource is designed. This can be a DC voltage value or the effective value of a sinusoidal AC voltage.
Nominal current ( $I_n$ )	The nominal current is the maximum permissible operating current which can be continuously passed through connection terminals marked with that value.
Line follow current quenching ( $I_f$ )	The follow current – also called network follow current – is the current which flows through the surge protection device after an arresting operation and is supplied by the network. The follow current differs considerably from the permanent operating current. The magnitude of the line follow current depends on the supply line from the transformer to the arrester.
Equipotential bonding	Electrical connection bringing the bodies of electrical equipment and extraneous conductive parts to the same or a similar potential.
Equipotential busbar (PAS)	A terminal or rail, intended to connect the protective conductor, the equipotential bonding cable and, if necessary, the conductor for function earthing with the earthing cable and the earthers.
Residual voltage ( $U_{res}$ )	The peak value of the voltage across the terminals of the surge protection device during or immediately following the passage of the arrested surge current.
Protection level ( $U_p$ )	The protection level is the maximum instantaneous voltage at the terminals of the surge protection device prior to response.
SPD	Surge protection device (arrester).
Temperature range	The operating temperature range specifies the upper and lower temperature limits between which the flawless functioning of a surge protection device is guaranteed.
Surge voltage	A surge voltage is a voltage occurring briefly between conductors or between a conductor and the earth which exceeds the highest permissible operating voltage value by a long way, but does not have the operating frequency. It can arise due to thunderstorms, earth faults and short circuits.
Surge arrester, type 1	SPDs, which, due to their special structure, are able to arrest lightning currents or partial lightning currents during direct strikes. Test pulse = 10/350
Surge arrester, type 2	SPDs that can arrest surge voltages caused by remote or nearby strikes or switching operations. Test pulse = 8/20
Surge arrester, type 3	SPDs used for the surge voltage protection of individual consumers or groups of consumers and used directly at the socket. Test pulse = 1.2/50 - 8/20
Transmission frequency ( $f_g$ )	The transmission frequency is the maximum frequency at which the insertion loss of a resource is still below 3 dB.
Surge protection device (SPD)	A device intended for the limitation of transient surge voltages and arresting of surge voltages. It contains at least one nonlinear component. Surge protection devices are also commonly referred to as "arrestors".
Back-up fuse before the arrestors	A back-up fuse must be fitted before arrestors. If the rating of the fuse before an arrester is higher than the maximum permissible back-up fuse rating for the arrester elements (see device technical data), the arrester must be fused selectively with the required value.
Transient surge voltage (TOV)	Temporary surge voltages are short term (i.e. temporary) surge voltages, which may occur due to errors within the medium and low-voltage network.
Mounting video	Videos on mounting the surge protection devices at: <a href="https://www.youtube.com/obodeutschland">https://www.youtube.com/obodeutschland</a>
	Differentiation: LPL = LPC = lightning protection class LPZ = lightning protection zone LPS = lightning protection system Important: Standardised terminology for technical terms/abbreviations



Tightening torques	
M5	4 Nm
M6	6 Nm
M8	12 Nm
M10	20 Nm

*Detailed information on tightening torques and technical data can be found in the installation manuals and is available on request.*

## Exclusion of liability

The publisher provides no guarantee of the actuality, correctness, completeness or quality of the information provided. Liability claims against the publisher for losses of a material or immaterial nature suffered as a result of the use or non-use of the information provided, or the use of incorrect or incomplete information, is strictly excluded, except where there is evidence of wilful intent or gross negligence on the part of the publisher. All offers are without obligation and non-binding. The publisher expressly reserves the right to amend, add to, remove individual pages from, or remove entirely, this offering, or to temporarily or permanently cease publication thereof, without giving notice to that effect.

The publisher hereby expressly declares that, at the time of placing of links in this offering, no illegal content was identifiable on the linked pages. The publisher has no influence over the current or future design, content or authorship of linked pages. It therefore hereby expressly distances itself from all content of all linked pages modified subsequent to the placing of the links. This statement applies to all links and references within the publisher's own Internet pages and to third-party contributions to guest books, forums and mailing lists set up by the publisher. Liability for any illegal, incorrect or incomplete content, and particularly for any loss resulting from the use or non-use of information presented in this way, shall be borne solely by the provider of the site to which the references are made, and not by the party who merely published a link to such content.

All brands named in the publisher's Internet pages, which may or may not be protected by third parties, are subject without limitation to the provisions of the relevant trademark legislation and the rights of ownership of the respective registered owner. The mere naming of a brand shall not be construed as an indication that the trademark is not protected by third-party rights.

The copyright for content and objects published and produced by the publisher itself shall remain solely with the publisher. The reproduction or use of such images and text in other electronic or printed publications is not permitted without the express consent of the publisher.

In situations where the publisher's Internet pages offer the opportunity to enter personal or business data (e-mail addresses, names, addresses), the divulgement of these data by the user shall be expressly on a purely voluntary basis. The avilment of and payment for all services offered shall be permitted – insofar as technically possible and reasonable – even if the customer does not provide these data, or if they instead supply anonymised data or a pseudonym. The use by third parties of the contact details published in the legal data, or comparable information such as postal addresses, telephone and fax numbers and e-mail addresses, for the sending of information that has not been expressly requested, is forbidden. Where this ban is breached, the right is expressly reserved to take legal action against the sender of such "spam" communications.

OBO Bettermann Holding GmbH & Co. KG  
 Hüingser Ring 52  
 58710 Menden  
 Germany  
 Telephone: +49 2373 89-0  
 Fax: +49 2373 89-238  
 E-mail: info@obo.de  
 Internet: www.obo.de

Directors with Representation Authorisation:  
 Ulrich Bettermann, Andreas Bettermann,  
 Dr. Jens Uwe Drowatzky, Prof. Dr. Robert Gröning,  
 Lajos Hernádi

Registration court: Arnsberg district court  
 Registration number: HRA 4854  
 VAT ID number according to § 27 a  
 VAT act:  
 DE 811 792 270

#### Exclusion of liability

OBO Bettermann Holding GmbH & Co. KG compiles the content of this website with great care and ensures that it is updated regularly. However, the data is only intended for the purpose of general information and does not replace comprehensive, individual consultation.

OBO Bettermann Holding GmbH & Co. KG does not accept any liability for the actuality, correctness and completeness of the information on these pages or for any infringement of round-the-clock, fault-free access. If we refer to the websites of third parties (links), then we do not accept any responsibility for the contents of the linked pages. Actuating the link causes you to leave the information presence of OBO Bettermann Holding GmbH & Co. KG. Therefore, different regulations may apply to the offers of third parties, particularly with regard to data protection. In addition, in the case of services, we will not accept any liability, in particular in the download of files made available on the websites of OBO Bettermann Holding GmbH & Co. KG, for any negligent infringements of obligations.

#### Data protection

All the personal data collected on the website of OBO Bettermann Holding GmbH & Co. KG will be stored and processed solely for your individual support, the transfer of product information or the provision of service offers. OBO Bettermann Holding GmbH & Co. KG promises that your data will be treated confidentially, in accordance with the valid data protection regulations.

#### Copyright

All the texts, images and other works published on the website are subject to – unless otherwise indicated – the copyright of OBO Bettermann Holding GmbH & Co. KG, Menden, Germany. Any copying, propagation, saving, transfer, sending and reproduction or forwarding of the contents is expressly forbidden without our written approval.

OBO Bettermann Vertrieb Deutschland GmbH & Co. KG  
Langer Brauck 25  
58640 Iserlohn  
GERMANY

Customer Service Germany  
Tel.: +49 23 73 89 - 17 00  
Fax: +49 23 73 89 - 12 38  
[export@obo.de](mailto:export@obo.de)

[www.obo-bettermann.com](http://www.obo-bettermann.com)

---

**Building Connections**





# Lightning protection guide



# TBS Lightning protection guide 2018

en

Bund

Bundle

Stand: 13/1/2020

LLExport\_02613

Wenn LAGERLISTE:

Dann in Leaflet die Variabel "Lagerliste\_JaNein"

auf Ja

und

Alle Variablen:

01_Bestelltabellensteuerung_45860 .....	372
02_Masstabellensteuerung_45861 .....	377
03_GelisteteMerkmaleBelastungen_45520 .....	
04_GelisteteMerkmaleAnschlMoegl_Benutzerdef_45519 .....	377
05_GelisteteMerkmaleEinbauTabel_Benutzerdef_45521 .....	45521
06_GelisteteMerkmaleKlassifikation_Datenblatt_4566 .....	
07_Kunden_Artikelnummer_13190 .....	
08_Kundenname_Tabellenkopf .....	
09_KundenartikelnummerExtraZeile_JaNein .....	Nein
10_Barcode_JaNein .....	Nein
11_Landeskennzeichen_0A0B_JaNein .....	Nein
12_Landeskennzeichen_0C_JaNein .....	Nein
13_SelektionsCode_JaNein_45988_45990 .....	Nein
14_LieferbarAb_JaNein_37860 .....	Ja
5_Lagerliste_JaNein .....	Nein
999_AbstandhalterHoehe .....	1,2
999_ChalfantNrAnzeigen_JaNein .....	Nein
999_ChalfantUmrechnung_JaNein .....	Nein
999_EAN_ValAID_WennKeineSpKundenNr .....	
999_EinzugUntenObenProdTabelle .....	0,6
999_Laenderkennzeichen_CID_QRCode .....	DE
999_MasseUmrechnenImperial_JaNein .....	Nein
999_Preis_ValAID .....	
999_Preiseinheit_JaNein .....	Nein
999_Rabattgruppen_JaNein .....	Nein
999_SchnittmarkenJaNein .....	Ja
999_StandardVPE .....	1
999_StratID_statt_GTIN_in_IV_JaNein .....	Nein
999_ZeileWerkstoffRabattJaNein .....	Ja
999_ZusText_Werkstoff_Lieferbar_auf_Anfrage_JaNein .....	Ja
999_crossAct_Farbhinterlegung_JaNein .....	nein
_nichtFuerPrintstrukturVerwenden_Ja=1Nein=0 .....	1

Katalogdatei:

S:\OBORD\190822 - Leitfaden TBS Blitzschutzleitfaden EN\In Bearbeitung\Leaflet\_LL12\_Katalog  
2018\_20190528\_Kataloge-Livestand\_Normal\_TBS\_Leitfaden\_EN\_20190723\_overlay.tsl