

Technical data sheet

Locknut, metric thread, black

Item number: 2049120



Locknut DIN 46319, with metric thread IEC 423.



PA Polyamide

Master data

Item number	2049120
Type	116 M50 SW PA
Description 1	Locknut
Manufacturer	OBO
Dimension	M50
Colour	Black
Material	Polyamide
Smallest sales unit	25
Unit of quantity	Piece
Weight	0.896 kg
Weight unit	kg/100 pc.
CO2 Footprint (GWP) Cradle-to-Gate	0,0467 kg CO2e / 1 Piece

Technical data sheet

Locknut, metric thread, black

Item number: 2049120



Dimensions



Dimension E	68 mm
Dimension L	8 mm

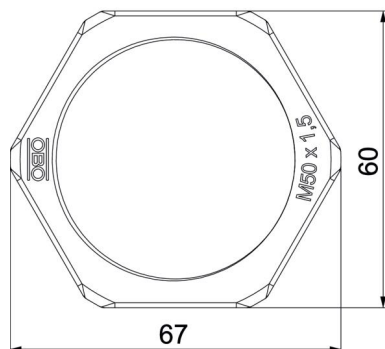

Technical data

Thread	M50 x 1,5
Thread type	Metric
Nominal thread size metric/PG	50
Fibre-glass reinforced	no
Halogen-free	yes
Impact-resistant	no
WAF	60