

Technical data sheet

Spacer clip 733 ALU

Item number: 1362822



Spacer clip for the installation of pipes and cables on walls, ceilings and floors.
With self-locking upper part. Fastening via slot.



Alu Aluminium

Master data

Item number	1362822
Type	ASL 733 30 ALU
Description 1	Distance saddle
Description 2	with slot
Manufacturer	OBO
Dimension	25-30mm
Material	Aluminium
Smallest sales unit	20
Unit of quantity	Piece
Weight	1.592 kg
Weight unit	kg/100 pc.
CO2 Footprint (GWP) Cradle-to-Gate	0,2321 kg CO2e / 1 Piece

Technical data sheet

Spacer clip 733 ALU

Item number: 1362822



Dimensions

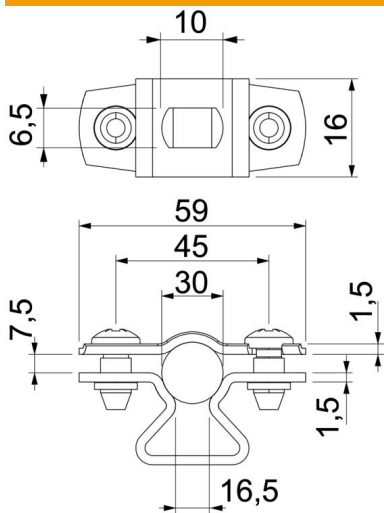

Dimension A	59 mm
Dimension B	45 mm
Dimension b	16 mm
Dimension D	30 mm
Dimension d max.	30 mm
Dimension d min.	25 mm
Dimension L	10 mm
Dimension s	16.5 mm
Dimension t1 (mm)	1.5
Dimension t2 (mm)	1.5
Dimension x	7.5 mm

Technical data

Distance to the wall	yes
Number of cables/pipes	1
Version for	Closed
Fastening type	Screw hole
For diameter	25 - 30
Halogen-free	yes
Plastic-covered	no
Material thickness	1.5 mm
Clamping range D, max.	30 mm
Clamping range D, min.	25 mm
UV-resistant	yes