

# Technical data sheet

## Reducer / stop-end FS

Item number: 7108109



Reducer/stop-end for cable trays with side height 35 mm.  
From a width of 150 mm, a perforated bottom flange is available.

Including appropriate fastening material.

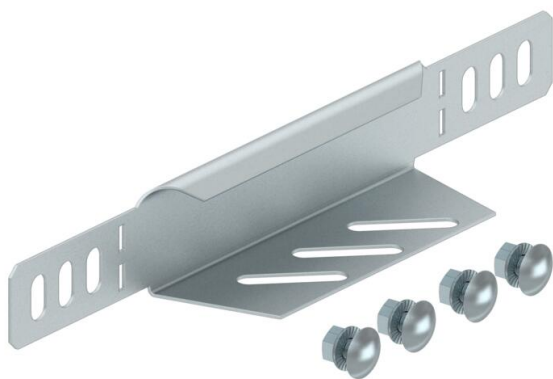

**St** Steel

**FS** Strip galvanized

### Master data

Item number	7108109
Description 1	Reducer profile/end closure
Description 2	for cable tray
Manufacturer	OBO
Dimension	35x100
Colour	zinc
Material	Steel
Surface	Strip galvanized
Surface standard	DIN EN 10346
Smallest sales unit	1
Unit of quantity	Piece
Weight	7.917 kg
Weight unit	kg/100 pc.

# Technical data sheet

Reducer / stop-end FS

Item number: 7108109



## Dimensions

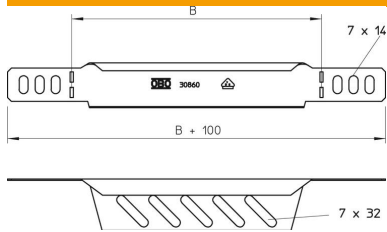

Width	100 mm
Width	4 in
Height	35 mm
Height	1 in
Plate thickness	1 mm
Dimension B	100 mm

## Technical data

Maintain electrical functions	no
Rustproof steel, pickled	no
Wide-span version	no