

Technical data sheet

Cable and pipe spacer clip 732 with threaded connection

Item number: 1360426



Mounting with screw-in spacer clips. Spacer clips and screw-in spacer clips are available in various materials: in V2A stainless steel, in electrogalvanised, hot-dip galvanised steel or in aluminium. Fastening can take place with bolt ties or angler anchors and Sprint screws.

Depending on the design, the clips can be "shot" using a bolt-firing tool or nail device.



St Steel

GTP Electrogalvanized, transparently passivated

Master data

Item number	1360426
Type	732 42 GTP
Description 1	Distance saddle
Description 2	with threaded connection M6
Manufacturer	OBO
Dimension	40-42mm
Material	Steel
Surface	Electrogalvanized, transparently passivated
Surface standard	
Smallest sales unit	25
Unit of quantity	Piece
Weight	3.84 kg
Weight unit	kg/100 pc.

Technical data sheet

Cable and pipe spacer clip 732 with threaded connection

Item number: 1360426



Dimensions

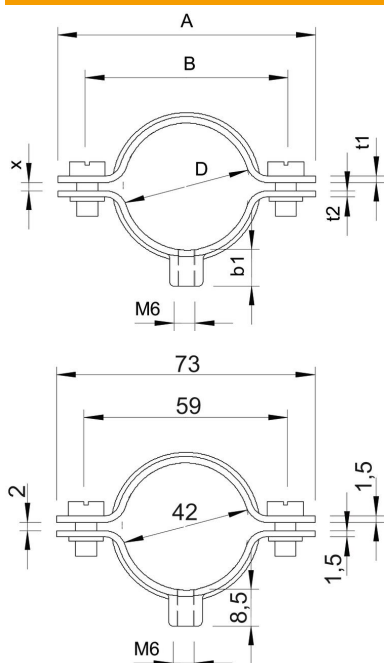

Length	73 mm
Dimension A	73 mm
Dimension B	59 mm
Dimension b1	8.5 mm
Dimension t1 (mm)	1.5
Dimension t2 (mm)	1.5
Dimension x	2 mm

Technical data

Distance to the wall	yes
Number of cables/pipes	1
Version for	Closed
Fastening type	Threaded connection
Suitable in fire protection area	yes
Size	M40
Halogen-free	yes
Plastic-covered	no
Hole size	M6 mm
Material thickness	1.5 mm
Bolt	M5 x 12
Clamping range D, max.	42 mm
Clamping range D, min.	40 mm
UV-resistant	yes