

Technical data sheet

Ribbon clip, 9 mm-wide

Item number: 2330342



Design D, double lock, UV and weather-resistant.



PA Polyamide

Master data

Item number	2330342
Type	550 9X760 SW
Description 1	Strip clip
Description 2	double lock
Manufacturer	OBO
Dimension	9x760mm
Colour	Black
Material	Polyamide
Smallest sales unit	100
Unit of quantity	Piece
Weight	1.35 kg
Weight unit	kg/100 pc.

Dimensions

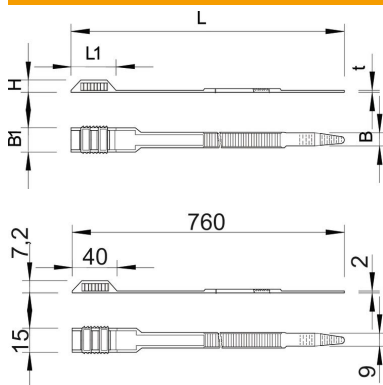

Dimension B	9 mm
Dimension L	760 mm
Dimension t	2 mm

Technical data sheet

Ribbon clip, 9 mm-wide

Item number: 2330342



Technical data

Version for	Externally toothed
Fastening type	Without
Halogen-free	yes
Max. Bundle diameter	220 mm
minimum breaking load	0.55 kN